

Outline Dimensions

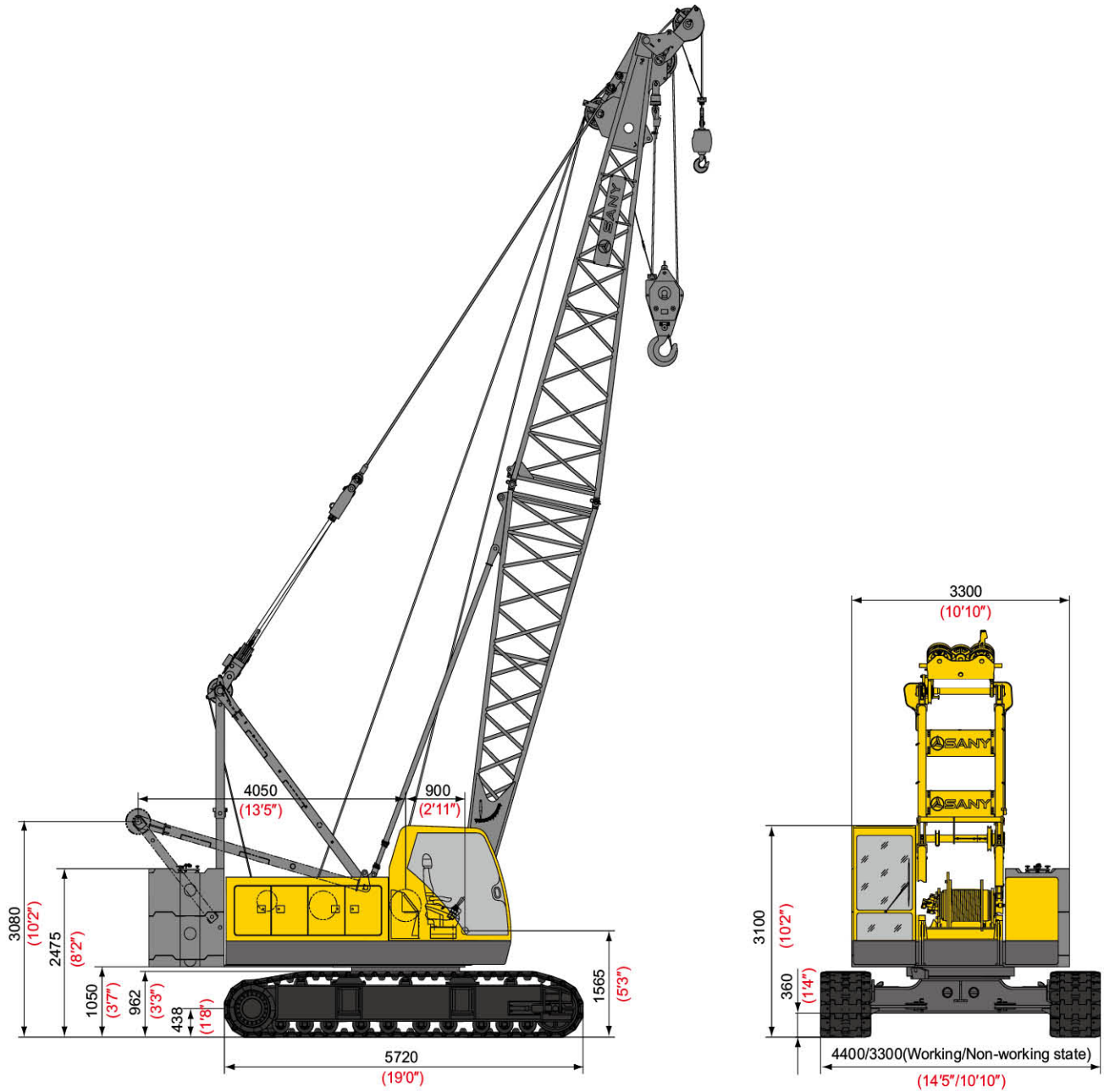

Outline Dimensions of SCC500E Hydraulic Crawler Crane

Performance Data

Main Technical Data of SCC500E Hydraulic Crawler Crane			
Performance Index		Unit	Data
H Operating Condition	Max. Rated Load	t (Ust)	55 (60.6)
	Boom Length	m (ft)	13~52 (42' 8" ~170' 7")
	Boom Luffing Angle		30° ~ 80°
FJ Operating Condition	Full Extensional Boom+ Full Extensional Jib	m (ft)	43+15.25 (141' 1" + 50')
	Jib Offset Angle		10° , 30°
Working Speed	Wire Speed of Main and Auxiliary Winch	m/min (fpm)	0~63/0~102 (R) (0~207/0~335) (R)
	Wire Speed of Luffing Winch	m/min (fpm)	0~73 (0~240)
	Slewing Speed	rpm	0~3.2/0~1.6
	Traveling Speed	km/h (mph)	0~1.39 (0~0.86)
Engine	Output Power/Rated Rotational Speed	kW/rpm (hp/rpm)	127/2000 (170/2000)
Transport Data	Maximum Single Unit Transport Weight	kg (lb)	30,000 (66,140)
	Transport Dimensions (length × width × height)	mm (ft)	7110 × 3300 × 3260 (23' 4" × 10' 10" × 10' 8")
	Average Ground Bearing Pressure	MPa (psi)	0.061 (8.9)

Transport Dimensions

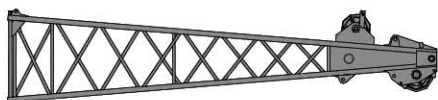
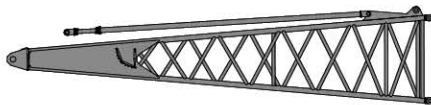
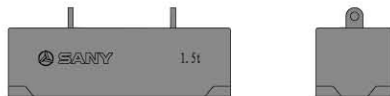
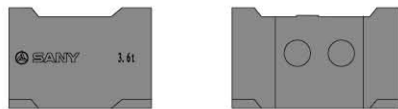
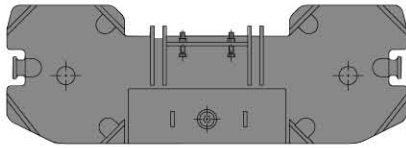
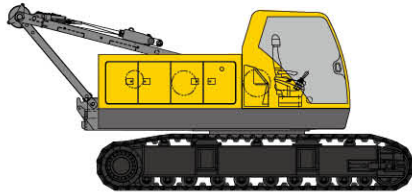

Basic Machine		×1
Length	7.11m	23' 4"
Width	3.30m	10' 10"
Height	3.26m	10' 8"
Weight	30000kg	66138lb

Counterweight Tray		×1
Length	3.30m	10' 10"
Width	1.14m	3' 9"
Height	0.79m	2' 7"
Weight	3100kg	6834lb

Left Counterweight Block		×2
Length	0.97m	3' 2"
Width	1.14m	3' 9"
Height	0.69m	2' 3"
Weight	3600kg	7937lb

Right Counterweight Block		×2
Length	0.97m	3' 2"
Width	1.14m	3' 9"
Height	0.69m	2' 3"
Weight	3600kg	7937lb

Additional Counterweight Block		×1
Length	1.30m	4' 3"
Width	0.45m	1' 6"
Height	0.515m	1' 8"
Weight	1500kg	3307lb

Boom Base		×1
Length	6.65m	21' 10"
Width	1.54m	5' 1"
Height	1.40m	4' 7"
Weight	1200kg	2646lb

Boom Tip		×1
Length	6.88m	22' 7"
Width	1.47m	4' 10"
Height	1.40m	4' 7"
Weight	1100kg	2425lb

Transport Dimensions

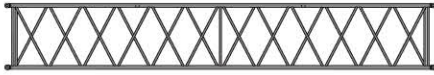

9m (29' 6'') Boom Insert B			× 2
Length	9.10m	29' 10"	
Width	1.40m	4' 7"	
Height	1.40m	4' 7"	
Weight	900kg	1984lb	

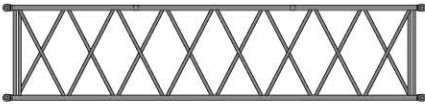

6m (19' 8'') Boom Insert B			× 3
Length	6.10m	20'	
Width	1.40m	4' 7"	
Height	1.40m	4' 7"	
Weight	600kg	1323lb	

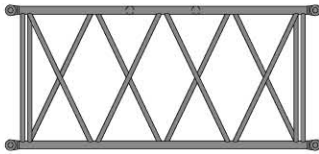

3m (9' 10'') Boom Insert			× 1
Length	3.10m	10' 2"	
Width	1.40m	4' 7"	
Height	1.40m	4' 7"	
Weight	400kg	882lb	

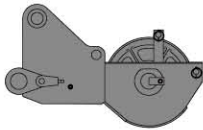

Extension Jib			× 1
Length	1.03m	3' 5"	
Width	0.72m	2' 4"	
Height	0.65m	2' 2"	
Weight	200kg	441lb	



Jib Base			× 1
Length	3.35m	10' 12"	
Width	0.60m	1' 12"	
Height	0.55m	1' 10"	
Weight	200kg	441lb	



Jib Tip			× 1
Length	3.35m	10' 12"	
Width	0.60m	1' 12"	
Height	0.55m	1' 10"	
Weight	200kg	441lb	

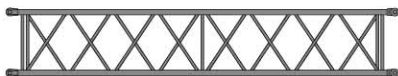

Jib Insert			× 3
Length	3.11m	10' 2"	
Width	0.60m	1' 12"	
Height	0.55m	1' 10"	
Weight	100kg	220lb	

Transport Dimensions

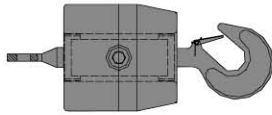

5t (5.5USt) Hook Block		× 1
Length	0.80m	2' 7"
Width	0.32m	1' 1"
Height	0.32m	1' 1"
Weight	200kg	441lb

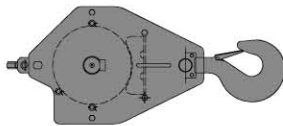

15t (16.5USt) Hook Block		× 1
Length	1.52m	4' 12"
Width	0.65m	2' 2"
Height	0.32m	1' 0"
Weight	400kg	882lb

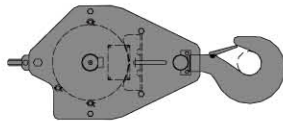

30t (33USt) Hook Block		× 1
Length	1.58m	5' 2"
Width	0.65m	2' 2"
Height	0.34m	1' 1"
Weight	500kg	1102lb

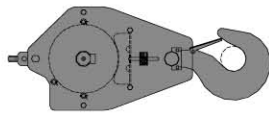

50t (55USt) Hook Block		× 1
Length	1.64m	5' 5"
Width	0.65m	2' 2"
Height	0.39m	1' 3"
Weight	600kg	1323lb

Notes:

- 1.The transport dimensions of main parts are not drawn to proportion. The dimensions in the sketches are design values excluding packages.
- 2.The weight is design value and there may be difference caused during manufacturing.

Hoisting Schematic Diagram

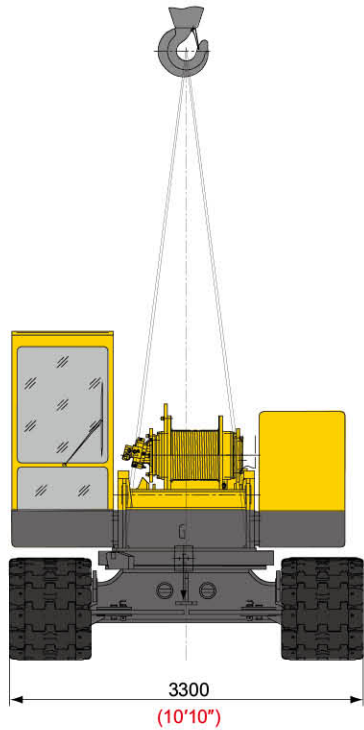
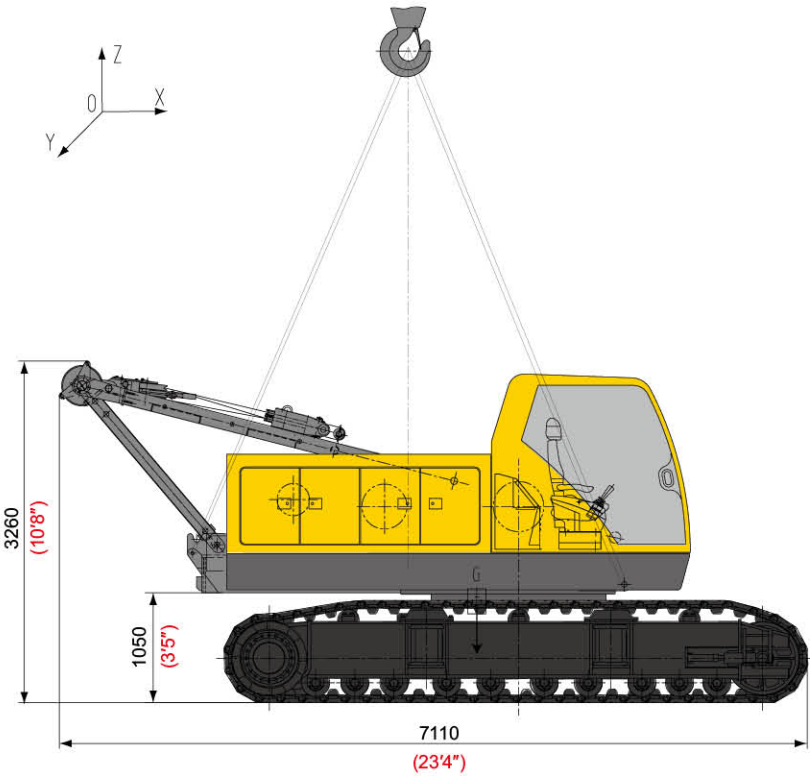

X=-390mm(15-6/16") Y=25mm(1") Z=950mm(37-6/16")

Specifications



Upperworks



Engine

The imported Cummins Model QSB6.7 diesel (Tier 3), inline 6-cylinders, water-cooled, electronic fuel injecting, turbo-charging, rated at 127kW (170hp) at 2000rpm. The maximum torque output is 658N•m(485lb ft), at 1500rpm.

Air Filtering two-stage air filtering system including an air pre-filter and an air filter.

Fuel tank capacity: 230L(60.8gal).

Optional, imported Cummins Model 6BTA5.9-C167 diesel (Tier 1), rated at 124kW(166hp)/2000rpm, maximum torque output is 651N•m (480lb•ft), at 1500rpm.



Electrical Controlling System

Composed of central controlling unit, man-machine interfaces, sensors, actuators, and connecting wires.

Data transmission between the controller, display, engine, load moment limiter, and remote controlling termination is achieved by CAN bus technology, enabling high reliability for the system.

Information including working parameters (e.g. rotational speed of the engine, fuel volume, engine oil pressure, servo pressure, wind speed, engine working hours) and working state (e.g. main winch lockup, main luffing winch lockup, slewing lockup) is shown on the display.

Security: design of electrical system fully complying with CE standards, multi safety limit switches, full range of safety signals, main components complying with CE standards.

Reliability: products of internationally or industrially well-known brands are employed in main electrical components, which include the load moment limiter, controller, display, sensor, detecting switches, control switches, wires and cables.

Amenity: all electrical parameters and states (e.g. rotational speed of the engine, fuel volume, engine oil pressure, servo pressure, wind speed, engine working hours, main winch lockup, main luffing winch lockup, and slewing lockup) are clearly seen on the instrument displays; separated design of assembling mode and operating mode fixes major hydraulic actions and hence reduces the operating workload for operator.

Advance: CAN bus technology for overall crane electrical system, power limit control for load, redundant transmission verification, and GPS and remote monitoring system (optional).



Hydraulic System

The hydraulic system configurations: Rexroth (R) or Kawasaki (K).

Rexroth pump system: the main pump is controlled by LAO, which is summation power adjustment plus electronic power adjustment override control, enabling load-sensitive function.

Rexroth main valve: integral multi-port valve, which can achieve LUDV, i.e. Load Independent Flow Distribution. If the flow in the system is inadequate, i.e. the pump unable to supply adequate flow for actuator components acting at required speed, then each actuator component will reduce its speed in proportion.

Independent closed slewing system:

Kawasaki pump system: the main pump is controlled by positive flow plus summation power. The displacement of main pump is proportional to control signal. When the summation output pressure of dual pump reaches the pre-set value, the displacement changing mechanism begin to act synchronically and reduce the pump displacement, keeping the summation output power of the pump constant. In addition, when the slewing pump and the main pump working at the same time, the cross power control can be achieved, avoiding the engine from working overloaded.

Kawasaki main valve: open-centered control valve unloaded at neutral position, which is hydraulic pilot proportional controlled. Spool of each valve is connected in series, achieving compound actions at light load. It is optional to install pressure compensated valve at the upstream of each spool, which can reduce the variation in load flow characteristics caused by change of load, enabling good adaptability for the operator.

Independent open slewing system

Oil cooler: oil radiator directly driven by hydraulic motor.

Hydraulic oil tank capacity: 260L(68.7gal).



Main & Auxiliary Hoisting Mechanism

The main winch drum and the auxiliary winch drum are separately driven by winch motors through gearboxes. Operate the hoisting control levers to achieve rolling in two directions, i.e. hoisting and lowering the hook block.

Brake: normally-closed, built-in, wet, blade-type, spring loaded; spring-applied and hydraulically-released.

Winch drum: using fold line groove winch drum to avoid entangling during winding the ropes into multi layers.

Specifications

Main & Aux. Hoisting Mechanism	Drum Diameter (R)	420mm (16-9/16")
	Outermost Speed of Wire Rope (R)	0 ~ 102m/min (High Speed) (0 ~ 335fpm)(High Speed) 0 ~ 63m/min (Low Speed) (0 ~ 207fpm)(Low Speed)
	Drum Diameter (K)	470mm (18-1/2")
	Outermost Speed of Wire Rope (K)	0 ~ 120m/min (0 ~ 394fpm)
	Wire Rope Diameter	20mm (13/16")
	Wire Rope Length of Main Winch	180m (590'7")
	Wire Rope Length of Aux. Winch	130m (426'6")
	Rated Single-line Pull	6,100kg (13,500lb)



Luffing Mechanism

The luffing winch drum is directly driven by luffing motor through gearbox. Operate the luffing control lever to achieve rolling in two directions, i.e. lifting and lowering the boom.

Brake: normally-closed, built-in, wet, blade-type, spring loaded; spring-applied and hydraulically-released.

Winch drum: using fold line groove winch drum to avoid entangling during winding the ropes into multi layers.

Luffing Mechanism	Drum Diameter (R)	290.8mm (11-7/16")
	Outermost Speed of Wire Rope (R)	0 ~ 73m/min (0 ~ 240fpm)
	Drum Diameter (K)	420mm (16-9/16")
	Outermost Speed of Wire Rope (K)	0 ~ 90m/min (0 ~ 295fpm)
	Wire Rope Diameter	16mm (5/8")
	Wire Rope Length of luffing Winch	142m (465'11")
	Rated Single-line Pull	3,700kg (8,200lb)



Slewing Mechanism

Internal gearing slewing driving system, allowing 360°rotation.

Brake: normally-closed, built-in, wet, blade-type, spring loaded; spring-applied and hydraulically-released.

Slewing lock: hydraulically-controlled locking pin is provided to ensure the upperworks are securely locked after work completion or during transportation.

Free slipping: during hoisting load, the center of gravity of the load and that of the boom might not be in the same plane due to mis-judging, when, the function of free slipping will rectify the upperworks to prevent the suspended load from wiggling.

Slewing ring: single-roll ball slewing ring.

Slewing speed (R) : 0~3.2r/min (I Speed)
0~1.6r/min (II Speed)

Slewing speed (K) : 0~2.7r/min



Driver's Cab

The sliding door of cab allows easy and safe opening and closing. The large window, together with lower beam and upper beam head lights and rearview mirror permit broad viewing area; location of air conditioner, MP3 player, seat, control levers, control buttons are all arranged

Specifications

ergonomically, making the operation more comfortable.
 Armrest box: the left and right armrest boxes are installed with control levers, electric switches, and ignition lock. The armrest boxes can also adjust with the seat.
 Seat: suspension, multi-direction, multi-position, installed with in-seat interlocking switch.
 Air conditioner: cool and warm wind, optimal wind tunnel and wind port.



Counterweight

The casting counterweight blocks are installed by piling one by one on counterweight tray, making easy assembly, disassembly and transportation.
 Standard counterweight weight is 17,500kg (38,600lb) in total, containing one 3,100kg (6,840lb) counterweight tray, two 3,600kg (7,940lb) left counterweight blocks and two 3,600kg (7,940lb) right counterweight blocks.
 One additional counterweight block of 1,500kg (3,310lb).
 Using the additional counterweight block in certain conditions with medium or long booms can improve the hoisting capability of the crane.



Lowerworks

Independent traveling drive is provided in each crawler frame. The hydraulic traveling motor drives gear reducer and achieves straight-line traveling and steering.
 Brake: normally-closed, built-in, wet, blade-type, spring loaded; spring-applied and hydraulically-released.
 Crawler telescoping is achieved by extending and retracting the crawler frame.
 Crawler tensioning is achieved by adjusting the shim plates with the guide rollers supported by hydraulic jack.
 Crawler pads are made of high-strength alloy steel casting.
 Traveling speed: 0~1.39km/h (0.86mph) (no load, on horizontal and hard ground)



Operation Device



Boom

Lattice structure, main chords use high-strength alloy steel pipe. Boom sections are connected with pin shafts. Basic boom is composed of one 6.5m(21'4") boom base and one 6.5m(21'4") boom tip.
 Boom inserts: 3m×1(9'10"×1), 6m×3(19'8"×3) and 9m×2(29'6"×2).
 Boom length: 13~52m(42'8"~170'7").



Fixed Jib

Lattice structure. Main chords use high-strength alloy steel pipe. Jib sections are connected with pin shafts. Basic jib is composed of one 3.05m (10') jib base and one 3.05m (10') jib tip.
 Jib insert: 3.05m×3 (10'×3)
 Jib length: 6.1m~15.25m (20'~50')
 Full Extensional Boom + Full Extensional Jib: 43m + 15.25m (141'1" +50').



Extension Jib

Welding structure, connected to main boom with pin shafts, used for installing auxiliary hook block.



Hook Blocks

50t(55USt) hook block
 30t(33USt) hook block
 15t(16.5USt) hook block
 5t(5.5USt) ball hook block
 Note: the above-mentioned devices are the complete configurations. Actual configuration see the purchase contract.



Safety Devices



Switch for Assembling Mode / Operating Mode

The over-hoist limit device, boom limits, A-frame alarming device, track telescopic alarming device, and load

Specifications

moment limiter can be overridden in the assembling mode.

While under normal operating mode, all these safety devices are functioning.

➤ Emergency Stop

When an emergency occurs, press this button to cut off the electricity and stop all the operations.

➤ Emergency Operating

If an operating system failure occurs, the emergency electric plugs can be connected to the standby power. Then the crane can be operated to safe state. During emergency operation, all safety devices stop functioning.

➤ Load Moment Limiter

The load moment limiter is independently controlled by computer and displays the actual load on the boom. It automatically detects the weight hoisted by the crane and the angle of boom, as well as displays the rated load, actual load, operating radius and angle of boom.

Components: host machine, monitor, angle sensor and force sensor etc.

Function: real-time display the rated load, actual load, operating radius, angle and height of the boom under the current situation of the crane. Automatically detect the dynamic data of an overload and sounds an alarm immediately and stop the operation.

➤ Over-hoist Limit Device for Main and Auxiliary Hooks

The limit switch and anti-two block on the upper boom are used to prevent the hook from being lifted too high. When the hook is lifted to a certain height, the limit switch is activated with a buzzer on the control board sending an alarm to both electronic and hydraulic controls, and the hook lifting operation stops automatically.

➤ Over Roll-out Limit Device for Main and Auxiliary Hooks

It is composed of the motion trigger device fixed inside of the drum and a proximity switch. It can send a signal when the wire rope is rolled out when there are only three wraps left on the drum. The electronic controlling system can automatically stop the hooks and send alarm through the buzzer and display.

➤ Function Locking

If the function locking joystick is not in position or the operator is not at seat, all the other control levers are out of commission so as to prevent mis-operation.

➤ Winch Lock Device

Electronic controlled locking device is set in all the winch drums, which means it is essential to release the ratchet before the winding operation so as to prevent the mis-operation caused by lever and to guarantee the safety when the winding is under non-operating mode.

➤ Slewing Lock Device

It uses hydraulic power pins to lock the upperworks at front or back. The slewing pin is electrically controlled, which can coordinate the slewing operation and prevent mis-operation.

➤ A-frame Alarming Device

Under normal operating mode, the A-frame alarm system is activated. The system sends an alarm through the buzzer and display, and all the operations stops at the same time.

➤ Boom Limit Device

When the boom angle is over 78° , the alarm buzzer sounds, and the luffing winch is stopped. The lowering operation is allowed. This protection function is the small for the load moment limiter and anti-two block switch.

When the angle of the boom is lower than 30° , the system sends an alarm through the buzzer and display of combined instruments. At the same time, the boom stops. The raising operation is allowed. This safeguard function is automatically controlled by load moment limiter.

➤ Boom Back-stop Device

The back-stop rod is made of nested steel pipe and spring structure fixed on the top of the lower boom, which is equipped with the function of support through the spring pressure so as to prevent the main boom retroversion.

➤ Boom Angle Indicator

Pendulum-type angle indicator mounted at the side close to the driver's cab of the lower boom.

Specifications

➤ Hook Clamp

Each kind of lifting hook is equipped with a clamp plate used to prevent the hoisting wire rope from falling off.

➤ Monitoring System

Camera: 2 cameras, respectively for monitoring the auxiliary winch, luffing winch and the situation of the rear of the crane for the complete appliance.

Optional: zoom camera, monitoring the working state of the hooks.

Optional: remote monitoring system, which is equipped with GPS and GPRS for data transmission, device status inquiry and data statistical analysis, running data supervision and analysis, and fault remote diagnosis.

➤ Lightning Protection Device

It includes grounding devices and surge-protect device, which can prevent the damage to the electronic components and the hurt to the staff from lightning.

➤ Gradienter

Electronic gradienter can indicate the inclining angle of the upperworks on the monitor of the control system.

➤ Tri-color Load Alarming Light

The load alarming light includes 3 colors, which can display the instantaneous load synchronously. Namely, the green color means the load rate is less than 92%, the yellow color means the load rate is between 92% to 100% and the red color means the load rate is over 100%, which is in overload situation. When the yellow light is on, the pre-alarm light begins to flicker and sound a discontinuous alarm; when the red light is on, the pre-alarm begins to flickert and sound a continuous alarm; when the actual load reaches 102% of rated load, the system will cut off those operations prone to danger.

➤ Audio-visual Alarm

When the engine is working, the alarm light is flickering; when the crane is traveling or slewing, it sounds an alarm.

➤ Illumination

Night illuminating devices such as winch illuminator, dipped light in front of the driver's cab, angle adjustable

high beam and head lamp in driver's cab are installed so as to improve safety for construction during night.

➤ Rearview Mirror

The mirrors shall be respectively set at the right side of the driver's cab and the front handrail of the left cover.

➤ Pharos

It is installed at the top of the boom system to send signal of height.

➤ Anemometer

It is installed at the top of the boom system to detect real-time wind speed and can transmit the data to the driver's cab for display on the monitor.

Key Words



Operating radius
Radius (R)



Main boom (H)
Boom angle
Mixed main boom (HJ)
Light main boom (H_L)

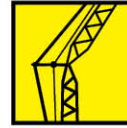

Fixed jib (FJ)
Fixed short jib (SF)
Light fixed short jib (SF_L)
Heavy fixed short jib (SF_H)



Luffing jib (LJ)



Superlift counterweight (B)
Superlift mast (D)

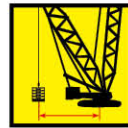

Superlift radius



Counterweight

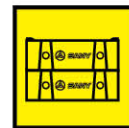

Central ballast

Operating Condition Code:

H: Heavy main boom

H_L: Light main boom

HD (HDB): Heavy main boom + superlift mast (+ superlift counterweight)

HJ: Mixed main boom

HJD (HJDB): Mixed main boom + superlift mast (+ superlift counterweight)

FJ: Fixed jib

LJ: Luffing jib

LJD (LJDB): Luffing jib + superlift mast (+ superlift counterweight)

SF: Fixed short jib

SF_L: Light fixed short jib

SF_LD SF_LDB): Light fixed short jib + superlift mast (+ superlift counterweight)

SF_H: Heavy fixed short jib

SF_HD (SF_HDB): Heavy fixed short jib + superlift mast (+ superlift counterweight)

Note: These keywords are general terms. A specific product may not use all of them.

Operating Conditions

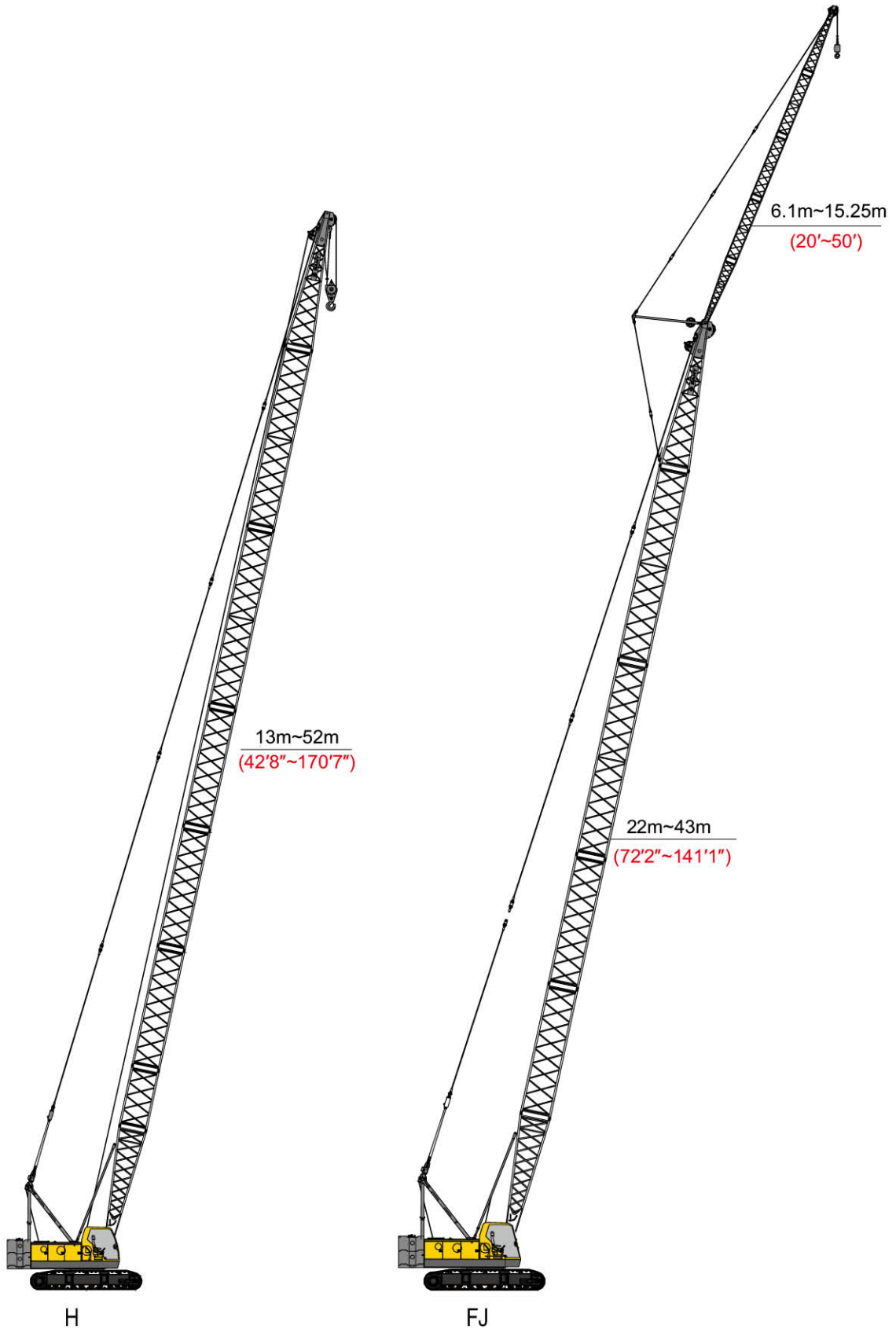

SCC500E Hydraulic Crawler Crane



H Operating Condition/Combination of Boom

Boom Length m(ft)	Basic Boom		Boom Insert		
	6.5m (21' 4") Base	6.5m (21' 4") Tip	3m (9'10")	6m (19'8")	9m (29'6")
13(42'8")	1	1	-	-	-
16 (52'6")	1	1	1	-	-
19 (62'4")	1	1	-	1	-
22 (72'2")	1	1	1	1	-
★22 (72'2")	1	1	-	-	1
25 (82')	1	1	-	2	-
28 (91'10")	1	1	1	2	-
★28 (91'10")	1	1	-	1	1
31(101'8")	1	1	1	1	1
★31 (101'8")	1	1	-	-	2
34 (111'7")	1	1	1	3	-
★34 (111'7")	1	1	1	-	2
37 (121'5")	1	1	1	2	1
★37 (121'5")	1	1	-	1	2
40 (131'3")	1	1	1	1	2
★40 (131'3")	1	1	-	3	1
43 (141'1")	1	1	1	3	1
★43 (141'1")	1	1	-	2	2
46 (150'11")	1	1	1	2	2
49 (160'9")	1	1	-	3	2
52 (170'7")	1	1	1	3	2

Note: The combinations with the sign of ★ are preferential.

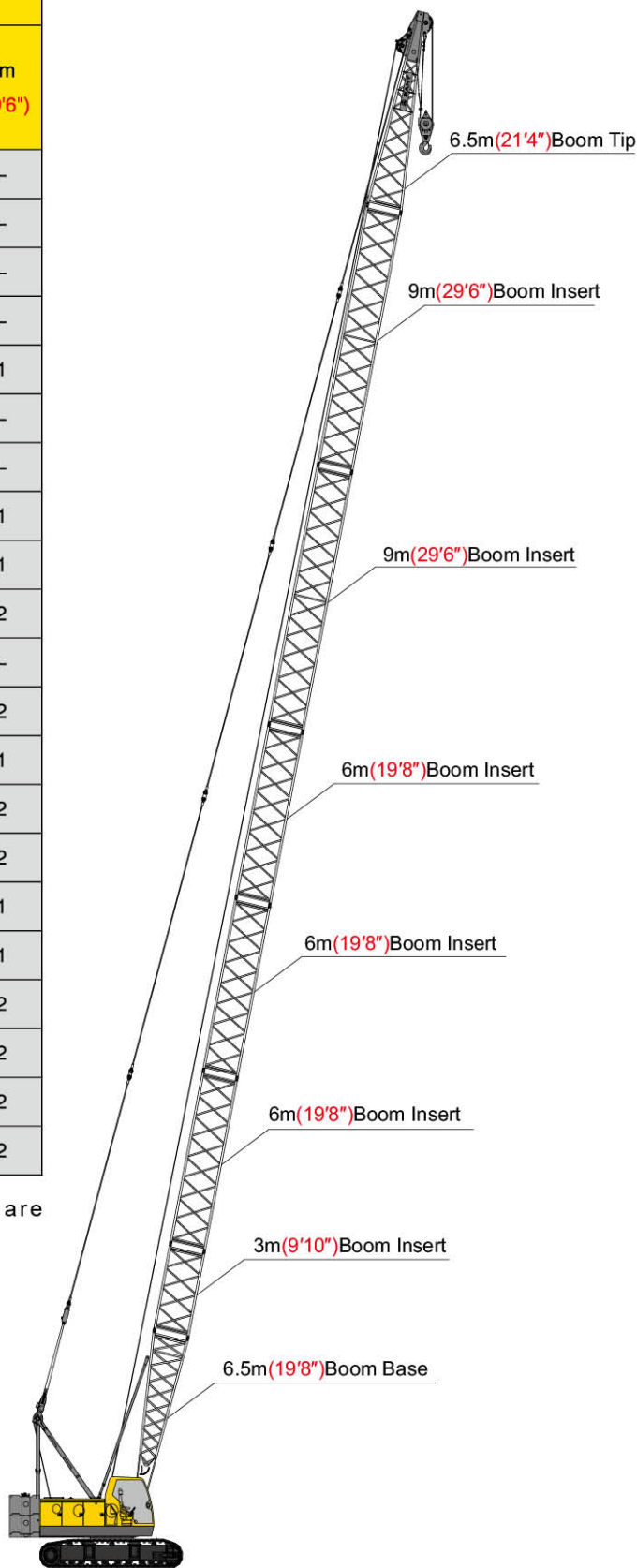

Operating Range Diagram

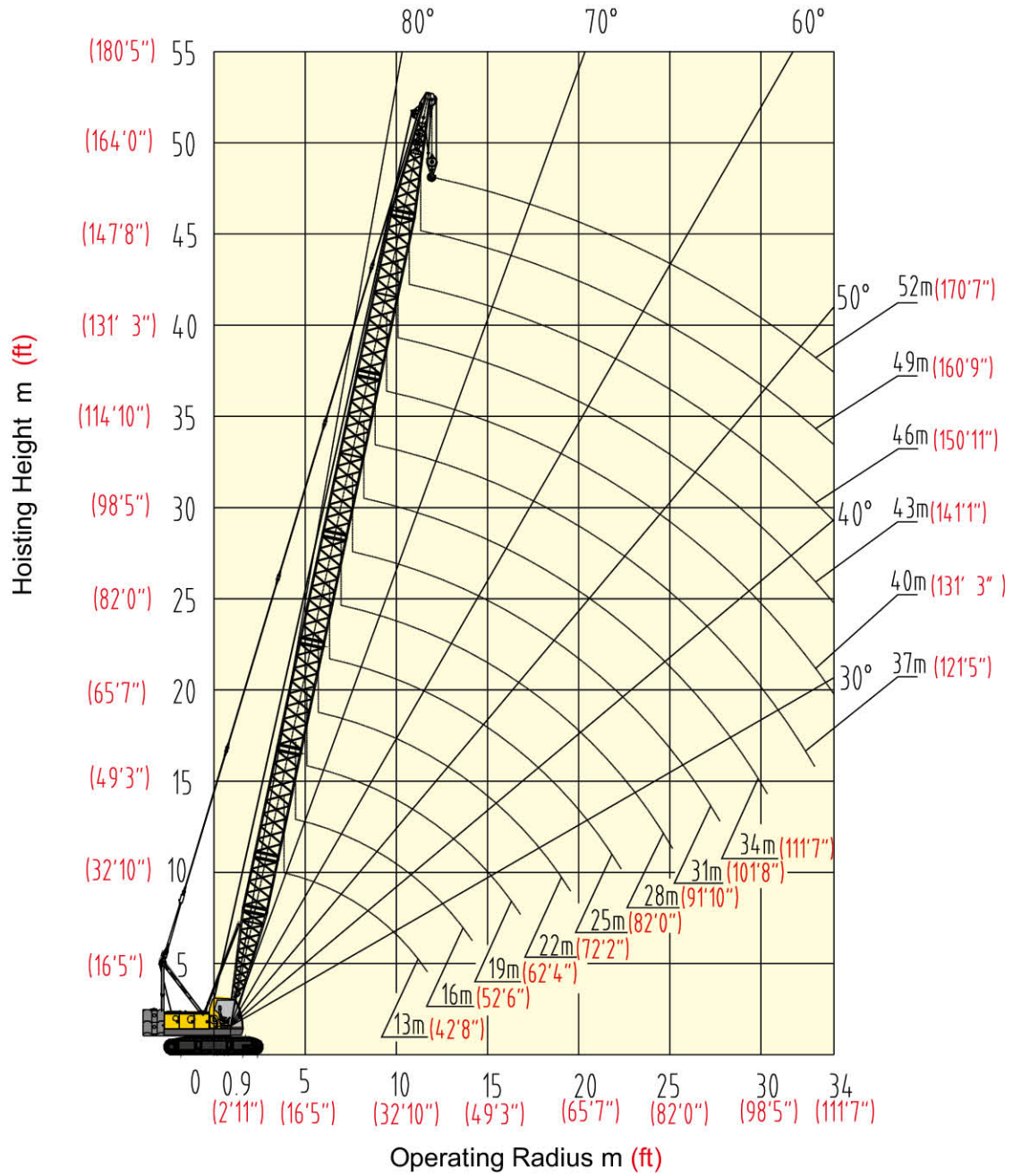

Main Boom Hoisting Height Diagram

Load Charts of H Operating Condition

Main Boom Load Charts 1/2											kg(lb)×1000	
Boom	13m	16m	19m	22m	25m	28m	31m	34m	37m			
Radius m (ft)	(42'8")	(52'6")	(62'4")	(72'2")	(82')	(91'10")	(101'8")	(111'7")	(121'5")			
3.7	55.00											
(12'2")	(121.25)											
4	46.00											
(13'1")	(101.41)											
4.5	39.06	39.02										
(14'9")	(86.11)	(86.02)										
5	32.77	32.72	32.62									
(16'5")	(72.24)	(72.13)	(71.91)									
5.5	28.19	28.13	28.03	27.94								
(18'1")	(62.15)	(62.02)	(61.79)	(61.6)								
6	24.70	24.64	24.54	24.44	24.37							
(19'8")	(54.45)	(54.32)	(54.1)	(53.88)	(53.73)							
7	19.74	19.69	19.57	19.47	19.40	19.30	19.20					
(22'12")	(43.52)	(43.41)	(43.14)	(42.92)	(42.77)	(42.55)	(42.33)					
8	16.40	16.30	16.20	16.10	16.00	15.90	15.80	15.70	16.60	15.70	16.50	
(26'3")	(36.16)	(35.93)	(35.71)	(35.49)	(35.27)	(35.05)	(34.83)	(34.61)	(36.6)	(34.61)	(36.38)	
9	14.00	13.90	13.80	13.70	13.60	13.50	13.40	13.30	14.10	13.20	14.00	
(29'6")	(30.86)	(30.64)	(30.42)	(30.2)	(29.98)	(29.76)	(29.54)	(29.32)	(31.08)	(29.1)	(30.86)	
10	12.14	12.10	12.00	11.90	11.80	11.70	11.60	11.50	12.20	11.40	12.10	
(32'10")	(26.76)	(26.68)	(26.46)	(26.23)	(26.01)	(25.79)	(25.57)	(25.35)	(26.9)	(25.13)	(26.68)	
12	9.56	9.50	9.40	9.30	9.20	9.10	9.00	8.90	9.40	8.80	9.40	
(39'4")	(21.08)	(20.94)	(20.72)	(20.5)	(20.28)	(20.06)	(19.84)	(19.62)	(20.72)	(19.4)	(20.72)	
14		7.77	7.60	7.50	7.40	7.30	7.20	7.10	7.60	7.00	7.50	
(45'11")		(17.13)	(16.75)	(16.53)	(16.31)	(16.09)	(15.87)	(15.65)	(16.75)	(15.43)	(16.53)	
16			6.39	6.28	6.20	6.09	5.97	5.86	6.30	5.78	6.22	
(52'6")			(14.09)	(13.84)	(13.67)	(13.43)	(13.16)	(12.92)	(13.88)	(12.74)	(13.71)	
18				5.34	5.26	5.15	5.03	4.92	5.31	4.84	5.23	
(59'1")				(11.77)	(11.6)	(11.35)	(11.09)	(10.85)	(11.7)	(10.67)	(11.53)	
20					4.52	4.41	4.30	4.19	4.54	4.10	4.45	
(65'7")					(9.96)	(9.72)	(9.48)	(9.24)	(10.01)	(9.04)	(9.81)	
22					3.94	3.82	3.71	3.60	3.92	3.51	3.83	
(72'2")					(8.69)	(8.42)	(8.18)	(7.94)	(8.64)	(7.74)	(8.44)	
24						3.34	3.23	3.12	3.41	3.03	3.32	
(78'9")						(7.36)	(7.12)	(6.88)	(7.52)	(6.68)	(7.32)	
26							2.82	2.71	2.98	2.62	2.89	
(85'4")							(6.22)	(5.97)	(6.57)	(5.78)	(6.37)	
28								2.35	2.60	2.24	2.49	
(91'10")								(5.18)	(5.73)	(4.94)	(5.49)	
30								2.03	2.26	1.91	2.14	
(98'5")								(4.48)	(4.99)	(4.21)	(4.73)	
32										1.63	1.85	
(104'12")										(3.59)	(4.08)	
Counter-weight kg(lb)×1000	17.5 (38.6)	17.5 (38.6)	17.5 (38.6)	17.5 (38.6)	17.5 (38.6)	17.5 (38.6)	17.5 (38.6)	17.5 (38.6)	17.5 (38.6)	17.5+1.5 (38.6+3.3)	17.5 (38.6)	17.5+1.5 (38.6+3.3)

Notes: 1. The actual lifting capacity is the value that rated lifting capacity in the table deducting the weight of hook block and other lifting tools, but the crane is not allowed to operate when the deducted value is less than 800kg(1,760lb).

2. Additional counterweight (1,500kg) (3,300lb) can only be used when the boom length is no less than 34m(111'7").

3. Cells 40% grayed and italicized indicate that the operating condition is with both the standard counterweight and additional counterweight; and cells framed and grayed indicate that the lifting capacity depends on strength of boom system.

Load Charts of H Operating Condition

Main Boom Load Charts 2/2											kg (lb) ×1000
Boom Radius m (ft)	40m (131'3")		43m (141'1")		46m (150'11")		49m (160'9")		52m (170'7")		
6 (19'8")											
7 (22'12")											
8 (26'3")											
9 (29'6")	13.11 (28.9)	<i>13.89 (30.62)</i>	13.03 (28.73)	<i>13.81 (30.44)</i>							
10 (32'10")	11.27 (24.85)	<i>11.97 (26.39)</i>	11.19 (24.67)	<i>11.89 (26.21)</i>	11.08 (24.43)	<i>11.78 (25.97)</i>	11.00 (24.25)	<i>11.70 (25.79)</i>			
12 (39'4")	8.67 (19.11)	<i>9.25 (20.4)</i>	8.58 (18.92)	<i>9.16 (20.2)</i>	8.48 (18.7)	<i>9.06 (19.98)</i>	8.39 (18.5)	<i>8.97 (19.78)</i>	8.29 (18.28)	<i>8.87 (19.56)</i>	
14 (45'11")	6.92 (15.26)	<i>7.42 (16.36)</i>	6.84 (15.08)	<i>7.34 (16.18)</i>	6.73 (14.84)	<i>7.23 (15.94)</i>	6.64 (14.64)	<i>7.14 (15.74)</i>	6.53 (14.4)	<i>7.03 (15.5)</i>	
16 (52'6")	5.67 (12.5)	<i>6.11 (13.46)</i>	5.58 (12.3)	<i>6.02 (13.27)</i>	5.47 (12.06)	<i>5.91 (13.02)</i>	5.39 (11.88)	<i>5.83 (12.85)</i>	5.27 (11.62)	<i>5.71 (12.58)</i>	
18 (59'1")	4.72 (10.41)	<i>5.11 (11.26)</i>	4.64 (10.23)	<i>5.03 (11.09)</i>	4.52 (9.96)	<i>4.91 (10.82)</i>	4.44 (9.79)	<i>4.83 (10.65)</i>	4.33 (9.55)	<i>4.72 (10.4)</i>	
20 (65'7")	3.99 (8.8)	<i>4.34 (9.57)</i>	3.90 (8.6)	<i>4.25 (9.37)</i>	3.79 (8.36)	<i>4.14 (9.13)</i>	3.70 (8.16)	<i>4.05 (8.93)</i>	3.59 (7.91)	<i>3.94 (8.69)</i>	
22 (72'2")	3.40 (7.5)	<i>3.70 (8.16)</i>	3.30 (7.28)	<i>3.60 (7.94)</i>	3.20 (7.05)	<i>3.50 (7.72)</i>	3.10 (6.83)	<i>3.40 (7.5)</i>	2.90 (6.39)	<i>3.30 (7.28)</i>	
24 (78'9")	2.90 (6.39)	<i>3.20 (7.05)</i>	2.80 (6.17)	<i>3.10 (6.83)</i>	2.70 (5.95)	<i>3.00 (6.61)</i>	2.60 (5.73)	<i>2.80 (6.17)</i>	2.40 (5.29)	<i>2.70 (5.95)</i>	
26 (85'4")	2.47 (5.45)	<i>2.70 (5.95)</i>	2.40 (5.29)	<i>2.60 (5.73)</i>	2.20 (4.85)	<i>2.50 (5.51)</i>	2.10 (4.63)	<i>2.40 (5.29)</i>	2.00 (4.41)	<i>2.20 (4.85)</i>	
28 (91'10")	2.09 (4.61)	<i>2.30 (5.07)</i>	2.00 (4.41)	<i>2.20 (4.85)</i>	1.80 (3.97)	<i>2.10 (4.63)</i>	1.70 (3.75)	<i>2.00 (4.41)</i>	1.60 (3.53)	<i>1.80 (3.97)</i>	
30 (98'5")	1.76 (3.88)	<i>1.99 (4.39)</i>	1.70 (3.75)	<i>1.90 (4.19)</i>	1.50 (3.31)	<i>1.70 (3.75)</i>	1.40 (3.09)	<i>1.60 (3.53)</i>	1.20 (2.65)	<i>1.50 (3.31)</i>	
32 (104'12")	1.48 (3.26)	<i>1.70 (3.75)</i>	1.36 (3)	<i>1.58 (3.48)</i>	1.22 (2.69)	<i>1.44 (3.17)</i>	1.10 (2.43)	<i>1.32 (2.91)</i>	0.95 (2.09)	<i>1.17 (2.58)</i>	
34 (111'7")	1.23 (2.71)	<i>1.44 (3.17)</i>	1.12 (2.47)	<i>1.33 (2.92)</i>	0.97 (2.14)	<i>1.18 (2.59)</i>	0.85 (1.87)	<i>1.06 (2.33)</i>	0.70 (1.54)	<i>0.91 (2)</i>	
Counter-weight kg (lb) ×1000	17.5 (38.6)	17.5+1.5 (38.6+3.3)	17.5 (38.6)	17.5+1.5 (38.6+3.3)	17.5 (38.6)	17.5+1.5 (38.6+3.3)	17.5 (38.6)	17.5+1.5 (38.6+3.3)	17.5 (38.6)	17.5+1.5 (38.6+3.3)	

Notes: 1. The actual lifting capacity is the value that rated lifting capacity in the table deducting the weight of hook block and other lifting tools, but the crane is not allowed to operate when the deducted value is less than 800kg(1,760lb).

2. Additional counterweight (1,500kg) (3,300lb) can only be used when the boom length is no less than 34m(111'7").

3. Cells 40% grayed and italicized indicate that the operating condition is with both the standard counterweight and additional counterweight; and cells framed and grayed indicate that the lifting capacity depends on strength of boom system.

Load Charts of H Operating Condition

Notes--Rated Load of the Crane

1. Crawler frames must be extended out when the crane is hoisting load.
2. Rated loads in the load charts are calculated in the condition that the crane is on hard, horizontal and evenly-supported ground to hoist load slowly and evenly at non-traveling state.
3. Rated loads in the load charts are calculated as 75% of the tipping load.
4. All rated loads listed in the load charts are all applicable to the whole 360°rotation.
5. The actual lifting capacity is the value that rated lifting capacity in the charts deducting the weight of hook block and other lifting tools (50t(55USt) hook block weighted at 580kg(1,280lb), 30t(33 USt) hook block weighted at 470kg(1,040lb), 15t(16.5USt) hook block weighted at 360kg(800 lb), 5t(5.5 USt) hook block weighted 190kg(420lb), and weight of wire ropes is calculated by 2kg/m(1.3lb/ft)), but the crane is not allowed to operate when the deducted value is less than 800kg(1,800lb).
6. Booms that allowed to install with fixed jib range from 22m(72'2") to 43m(141'1"), and the maximum boom length allowed to install with extension jib is 49m(160'9").
7. Relations between the rate of wire ropes and maximum rated load as well as weight of hook block are as follows:

Hook Block Type t (USt)	Weight of Hook Block kg (lb)	Maximum Rated Load t (USt)								
		9 Rates	8 Rates	7 Rates	6 Rates	5 Rates	4 Rates	3 Rates	2 Rates	1 Rate
50 (55)	580 (1280)	55.0 (60.6)	44.8 (49.4)	39.9 (44.0)	34.2 (37.7)	28.5 (31.4)	22.8 (25.1)	17.1 (18.8)	11.4 (12.6)	5.7 (6.3)
30 (33.1)	470 (1040)				30.0 (33.1)	28.5 (31.4)	22.8 (25.1)	17.1 (18.8)	11.4 (12.6)	5.7 (6.3)
15 (16.5)	360 (800)							15.0 (16.5)	11.4 (12.6)	5.7 (6.3)
5 (5.5)	190 (420)									5.0 (5.5)

8. Operating condition with additional counterweight (17,000kg+1,500kg) (37,480lb+3,310lb) is optional, not standard. Booms that are allowed to install with additional counterweight range from 34m(111'7") to 52m(170'7").

FJ Operating Condition/Combinations of Boom and Jib

Jib Length m (ft)	Basic Jib		Jib Insert	Boom Length m (ft)	Jib Offset Angle
	3.05m(10')Base	3.05m(10')Tip	3.05m(10')		
6.10(20')	1	1	-	22 ~ 43(72' 2" ~ 141' 1")	10° 、 30°
9.15(30')	1	1	1	22 ~ 43(72' 2" ~ 141' 1")	10° 、 30°
12.2(40')	1	1	2	22 ~ 43(72' 2" ~ 141' 1")	10° 、 30°
15.25(50')	1	1	3	22 ~ 43(72' 2" ~ 141' 1")	10° 、 30°

Operating Range Diagram

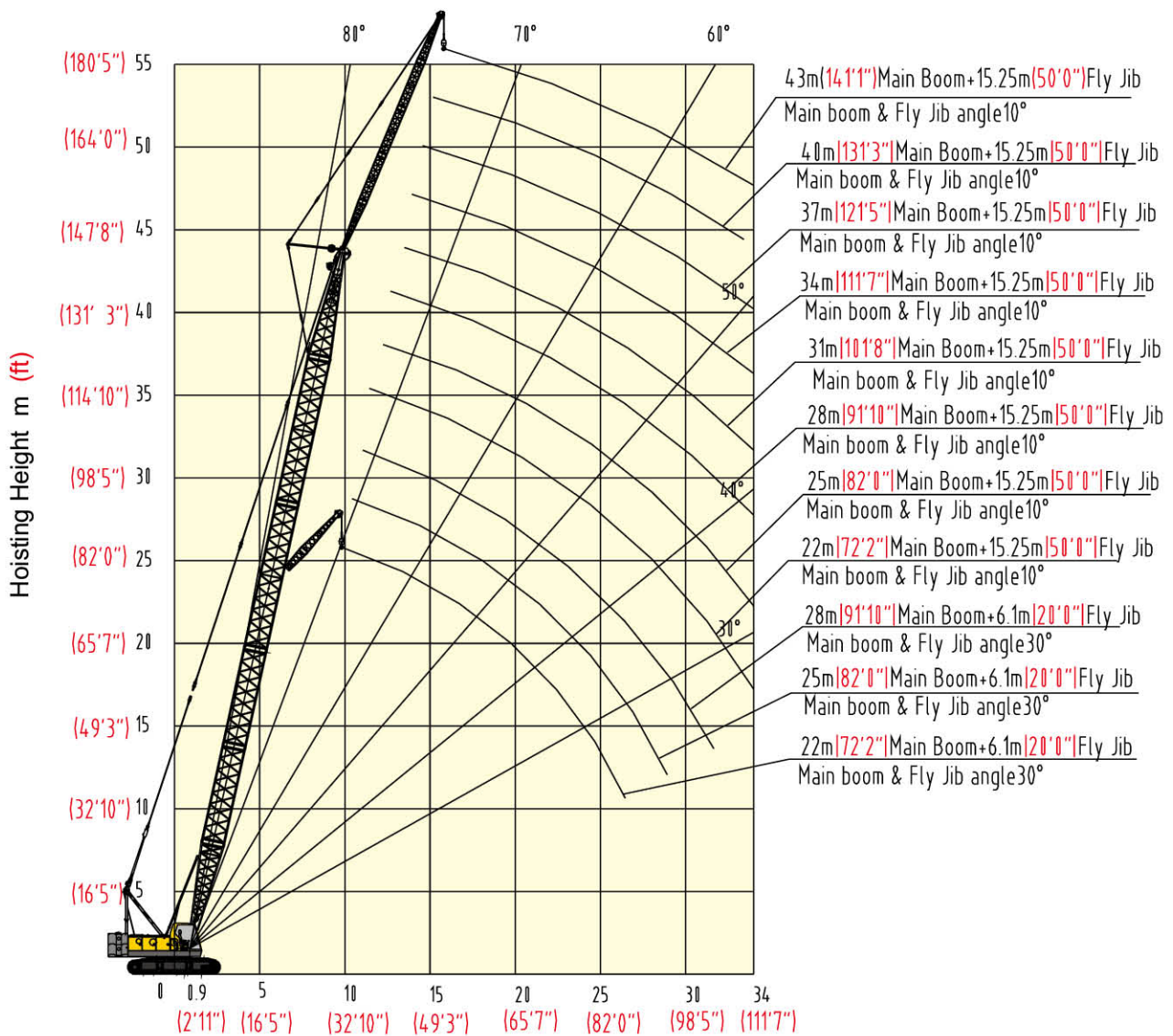

Operating Radius m (ft)
Fixed Jib Hoisting Height Diagram

Load Charts of FJ Operating Condition

Fixed Jib Load Charts 1/4									kg(lb)×1000
Main Boom 22m (72'2")									
Jib m (ft)	6.1(20')		9.15(30')		12.2(40')		15.25(50')		
Jib angle	10°	30°	10°	30°	10°	30°	10°	30°	
Radius m(ft)									
8 (26'3")	5.00 (11.02)	9.8m×5.00 (32'2"×11.02)	9.2m×5.00 (30'2"×11.02)						
10 (32'10")	5.00 (11.02)	5.00 (11.02)	5.00 (11.02)		10.3m×4.00 (33'10"×8.82)		11.4m×3.20 (37'5"×7.05)		
12 (39'4")	5.00 (11.02)	5.00 (11.02)	5.00 (11.02)	4.65 (10.25)	4.00 (8.82)		3.20 (7.05)		
14 (45'11")	5.00 (11.02)	15.4m×5.00 (50'6"×11.02)	5.00 (11.02)	4.30 (9.48)	4.00 (8.82)	3.65 (8.05)	3.20 (7.05)		
16 (52'6")	5.00 (11.02)	4.90 (10.8)	5.00 (11.02)	4.05 (8.93)	4.00 (8.82)	3.45 (7.61)	16.8m×3.20 (55'1"×7.05)	3.05 (6.72)	
18 (59'1")	19.5m×5.00 (63'12"×11.02)	4.65 (10.25)	19.7m×5.00 (64'8"×11.02)	3.85 (8.49)	19.8m×3.85 (64'12"×8.49)	3.25 (7.16)	3.15 (6.94)	2.90 (6.39)	
20 (65'7")	4.80 (10.58)	21.7m×4.30 (71'2"×9.48)	4.85 (10.69)	3.65 (8.05)	3.75 (8.27)	3.10 (6.83)	3.05 (6.72)	2.75 (6.06)	
22 (72'2")	4.20 (9.26)	4.20 (9.26)	4.25 (9.37)	3.50 (7.72)	3.65 (8.05)	2.95 (6.5)	2.95 (6.5)	2.60 (5.73)	
24 (78'9")	3.70 (8.16)	3.75 (8.27)	3.75 (8.27)	3.35 (7.39)	3.50 (7.72)	2.80 (6.17)	2.90 (6.39)	2.45 (5.4)	
26 (85'4")	3.30 (7.28)	3.35 (7.39)	3.35 (7.39)	27.2m×3.20 (89'3"×7.05)	3.40 (7.5)	2.70 (5.95)	2.80 (6.17)	2.35 (5.18)	
28 (91'10")	26.1m×3.30 (85'8"×7.28)	26.5m×3.25 (86'11"×7.16)	3.05 (6.72)	3.05 (6.72)	3.05 (6.72)	2.60 (5.73)	2.70 (5.95)	2.25 (4.96)	
30 (98'5")			29.0m×2.90 (95'2"×6.39)	29.0m×3.85 (95'2"×8.49)	2.75 (6.06)	2.55 (5.62)	2.60 (5.73)	2.15 (4.74)	
32 (104'12")					31.8m×2.50 (104'4"×5.51)	2.50 (5.51)	2.50 (5.51)	2.10 (4.63)	
34 (111'7")						32.6m×2.50 (106'11"×5.51)	2.30 (5.07)	2.05 (4.52)	
Counterweight kg(lb)×1000	17.5 (38.6)	17.5 (38.6)	17.5 (38.6)	17.5 (38.6)	17.5 (38.6)	17.5 (38.6)	17.5 (38.6)	17.5 (38.6)	
Main Boom 25m (82')									
Jib m (ft)	6.1(20')		9.15(30')		12.2(40')		15.25(50')		
Jib angle	10°	30°	10°	30°	10°	30°	10°	30°	
Radius m(ft)									
8 (26'3")	8.6m×5.00 (28'3"×11.02)		9.8m×5.00 (32'2"×11.02)		10.9m×4.00 (35'9"×8.82)				
10 (32'10")	5.00 (11.02)	10.4m×5.00 (34'1"×11.02)	5.00 (11.02)		4.00 (8.82)				
12 (39'4")	5.00 (11.02)	5.00 (11.02)	5.00 (11.02)	12.5m×4.65 (41'0"×10.25)	4.00 (8.82)		12.1m×3.65 (39'8"×8.05)		
14 (45'11")	5.00 (11.02)	5.00 (11.02)	5.00 (11.02)	4.40 (9.7)	4.00 (8.82)	14.5m×3.65 (47'7"×8.05)	3.20 (7.05)		
16 (52'6")	5.00 (11.02)	16.5m×5.00 (54'2"×11.02)	5.00 (11.02)	4.15 (9.15)	3.85 (8.49)	3.50 (7.72)	16.5m×3.20 (54'2"×7.05)	16.6m×3.05 (54'6"×6.72)	
18 (59'1")	19.3m×5.00 (63'4"×11.02)	4.80 (10.58)	19.5m×5.00 (63'12"×11.02)	3.90 (8.6)	3.75 (8.27)	3.35 (7.39)	3.15 (6.94)	2.95 (6.5)	
20 (65'7")	4.70 (10.36)	20.6m×4.55 (67'7"×10.03)	4.80 (10.58)	3.70 (8.16)	3.65 (8.05)	3.20 (7.05)	3.05 (6.72)	2.80 (6.17)	
22 (72'2")	4.10 (9.04)	4.15 (9.15)	4.20 (9.26)	3.55 (7.83)	3.50 (7.72)	3.05 (6.72)	2.95 (6.5)	2.65 (5.84)	
24 (78'9")	3.65 (8.05)	3.65 (8.05)	3.70 (8.16)	3.40 (7.5)	3.30 (7.28)	2.90 (6.39)	2.90 (6.39)	2.55 (5.62)	
26 (85'4")	3.25 (7.16)	3.25 (7.16)	3.30 (7.28)	3.30 (7.28)	2.95 (6.5)	2.80 (6.17)	2.80 (6.17)	2.40 (5.29)	
28 (91'10")	2.90 (6.39)	2.90 (6.39)	2.95 (6.5)	3.00 (6.61)	2.65 (5.84)	2.70 (5.95)	2.70 (5.95)	2.30 (5.07)	
30 (98'5")	28.7m×2.80 (94'2"×6.17)	29.1m×2.75 (95'6"×6.06)	2.65 (5.84)	2.70 (5.95)	2.40 (5.29)	31.4m×2.60 (103'0"×5.73)	2.65 (5.84)	2.20 (4.85)	
32 (104'12")			31.6m×2.45 (103'8"×5.4)	2.40 (5.29)	2.20 (4.85)	2.40 (5.29)	2.45 (5.4)	2.20 (4.85)	
34 (111'7")						2.25 (4.96)	2.20 (4.85)	2.10 (4.63)	
Counterweight kg(lb)×1000	17.5 (38.6)	17.5 (38.6)	17.5 (38.6)	17.5 (38.6)	17.5 (38.6)	17.5 (38.6)	17.5 (38.6)	17.5 (38.6)	

Notes: 1. The actual lifting capacity is the value that rated lifting capacity in the table deducting the weight of hook block and other lifting tools, but the crane is not allowed to operate when the deducted value is less than 800kg(1,760lb).

2. Cells framed and 25% grayed indicate that the load value depends on the strength of boom system.

Load Charts of FJ Operating Condition

Fixed Jib Load Charts 2/4									kg(lb)×1000
Main Boom 28m (91'10")									
Jib m (ft)	6.1 (20°)		9.15 (30°)		12.2 (40°)		15.25 (50°)		
Jib angle	10°	30°	10°	30°	10°	30°	10°	30°	
Radius m (ft)									
8 (26'3")	9.3m×5.00 (30'6"×11.02)								
10 (32'10")	5.00 (11.02)	11.1m×5.00 (36'5"×11.02)	10.4m×5.00 (34'1"×11.02)		11.6m×4.00 (38'1"×8.82)				
12 (39'4")	5.00 (11.02)	5.00 (11.02)	5.00 (11.02)	13.1m×4.65 (42'12"×10.25)	4.00 (8.82)		12.7m×5.20 (41'8"×11.46)		
14 (45'11")	5.00 (11.02)	5.00 (11.02)	5.00 (11.02)	4.50 (9.92)	4.00 (8.82)	15.1m×3.05 (49'6"×6.72)	3.20 (7.05)		
16 (52'6")	5.00 (11.02)	17.7m×5.00 (58'1"×11.02)	5.00 (11.02)	4.25 (9.37)	4.00 (8.82)	3.60 (7.94)	16.8m×3.20 (55'1"×7.05)	17.2m×3.05 (56'5"×6.72)	
18 (59'1")	19.0m×5.00 (62'4"×11.02)	19.8m×4.75 (64'12"×10.47)	19.2m×5.00 (62'12"×11.02)	4.05 (8.93)	3.85 (8.49)	3.45 (7.61)	3.15 (6.94)	3.00 (6.61)	
20 (65'7")	4.60 (10.14)	4.70 (10.36)	4.70 (10.36)	3.85 (8.49)	3.75 (8.27)	3.30 (7.28)	3.05 (6.72)	2.85 (6.28)	
22 (72'2")	4.00 (8.82)	4.10 (9.04)	4.10 (9.04)	3.70 (8.16)	3.65 (8.05)	3.15 (6.94)	2.95 (6.5)	2.75 (6.06)	
24 (78'9")	3.50 (7.72)	3.60 (7.94)	3.60 (7.94)	24.8m×3.50 (81'4"×7.72)	3.50 (7.72)	3.00 (6.61)	2.90 (6.39)	2.60 (5.73)	
26 (85'4")	3.10 (6.83)	3.15 (6.94)	3.20 (7.05)	3.25 (7.16)	3.20 (7.05)	2.85 (6.28)	2.80 (6.17)	2.50 (5.51)	
28 (91'10")	2.75 (6.06)	2.80 (6.17)	2.85 (6.28)	2.90 (6.39)	2.85 (6.28)	2.75 (6.06)	2.70 (5.95)	2.40 (5.29)	
30 (98'5")	2.45 (5.4)	2.50 (5.51)	2.55 (5.62)	2.60 (5.73)	2.55 (5.62)	2.65 (5.84)	2.60 (5.73)	2.30 (5.07)	
32 (104'12")	31.3m×2.30 (102'8"×5.07)	31.7m×2.30 (104'0"×5.07)	2.30 (5.07)	2.30 (5.07)	2.30 (5.07)	2.40 (5.29)	2.35 (5.18)	2.20 (4.85)	
34 (111'7")			2.05 (4.52)	2.10 (4.63)	2.10 (4.63)	2.15 (4.74)	2.10 (4.63)	2.15 (4.74)	
Counterweight kg(lb)×1000	17.5 (38.6)	17.5 (38.6)	17.5 (38.6)	17.5 (38.6)	17.5 (38.6)	17.5 (38.6)	17.5 (38.6)	17.5 (38.6)	
Main Boom 31m (101'8")									
Jib m (ft)	6.1 (20°)		9.15 (30°)		12.2 (40°)		15.25 (50°)		
Jib angle	10°	30°	10°	30°	10°	30°	10°	30°	
Radius m (ft)									
8 (26'3")	9.9m×5.00 (32'6"×11.02)								
10 (32'10")	5.00 (11.02)	11.7m×5.00 (38'5"×11.02)	11.0m×5.00 (36'1"×11.02)						
12 (39'4")	5.00 (11.02)	5.00 (11.02)	5.00 (11.02)	13.7m×4.65 (44'11"×10.25)	12.2m×4.00 (40'0"×8.82)		13.3m×3.20 (43'8"×7.05)		
14 (45'11")	5.00 (11.02)	5.00 (11.02)	5.00 (11.02)	4.60 (10.14)	4.00 (8.82)		3.20 (7.05)		
16 (52'6")	5.00 (11.02)	5.00 (11.02)	5.00 (11.02)	4.35 (9.59)	4.00 (8.82)	3.65 (8.05)	16.8m×3.20 (55'1"×7.05)		
18 (59'1")	18.8m×5.00 (61'8"×11.02)	19.0m×5.00 (62'4"×11.02)	19.0m×5.00 (62'4"×11.02)	4.15 (9.15)	3.85 (8.49)	3.50 (7.72)	3.15 (6.94)	3.05 (6.72)	
20 (65'7")	4.50 (9.92)	4.65 (10.25)	4.65 (10.25)	3.95 (8.71)	3.75 (8.27)	3.35 (7.39)	3.05 (6.72)	2.95 (6.5)	
22 (72'2")	3.95 (8.71)	4.00 (8.82)	4.00 (8.82)	23.6m×3.70 (77'5"×8.16)	3.65 (8.05)	3.20 (7.05)	2.95 (6.5)	2.80 (6.17)	
24 (78'9")	3.45 (7.61)	3.50 (7.72)	3.50 (7.72)	3.60 (7.94)	3.50 (7.72)	3.10 (6.83)	2.90 (6.39)	2.65 (5.84)	
26 (85'4")	3.05 (6.72)	3.10 (6.83)	3.10 (6.83)	3.20 (7.05)	3.15 (6.94)	2.95 (6.5)	2.80 (6.17)	2.55 (5.62)	
28 (91'10")	2.70 (5.95)	2.75 (6.06)	2.75 (6.06)	2.85 (6.28)	2.85 (6.28)	2.85 (6.28)	2.75 (6.06)	2.45 (5.4)	
30 (98'5")	2.40 (5.29)	2.45 (5.4)	2.45 (5.4)	2.55 (5.62)	2.50 (5.51)	2.60 (5.73)	2.50 (5.51)	2.35 (5.18)	
32 (104'12")	2.15 (4.74)	2.20 (4.85)	2.20 (4.85)	2.25 (4.96)	2.25 (4.96)	2.30 (5.07)	2.25 (4.96)	2.25 (4.96)	
34 (111'7")	33.9m×1.90 (111'3"×4.19)	1.95 (4.3)	1.95 (4.3)	2.00 (4.41)	2.00 (4.41)	2.10 (4.63)	2.05 (4.52)	2.15 (4.74)	
Counterweight kg(lb)×1000	17.5 (38.6)	17.5 (38.6)	17.5 (38.6)	17.5 (38.6)	17.5 (38.6)	17.5 (38.6)	17.5 (38.6)	17.5 (38.6)	

Notes: 1. The actual lifting capacity is the value that rated lifting capacity in the table deducting the weight of hook block and other lifting tools, but the crane is not allowed to operate when the deducted value is less than 800kg(1,760lb).

2. Cells framed and 25% grayed indicate that the load value depends on the strength of boom system.

Load Charts of FJ Operating Condition

Fixed Jib Load Charts 3/4									kg(lb)×1000
Main Boom 34m (111'7")									
Jib m (ft)	6.1 (20')		9.15 (30')		12.2 (40')		15.25 (50')		
Jib angle	10°	30°	10°	30°	10°	30°	10°	30°	
Radius m (ft)									
10 (32'10")	10.5m×5.00 (34'5"×11.02)		11.7m×5.00 (38'5"×11.02)						
12 (39'4")	5.00 (11.02)	12.3m×5.00 (40'4"×11.02)	5.00 (11.02)		12.8m×4.00 (41'12"×8.82)		13.9m×3.20 (45'7"×7.05)		
14 (45'11")	5.00 (11.02)	5.00 (11.02)	5.00 (11.02)	14.4m×4.60 (47'3"×10.14)	4.00 (8.82)		3.20 (7.05)		
16 (52'6")	5.00 (11.02)	5.00 (11.02)	5.00 (11.02)	4.45 (9.81)	4.00 (8.82)	16.4m×3.65 (53'10"×8.05)	16.8m×3.20 (55'1"×7.05)		
18 (59'1")	18.6m×5.00 (61'0"×11.02)	18.8m×5.00 (61'8"×11.02)	18.8m×5.00 (61'8"×11.02)	4.25 (9.37)	3.85 (8.49)	3.55 (7.83)	3.15 (6.94)	18.4m×3.05 (60'4"×6.72)	
20 (65'7")	4.45 (9.81)	4.60 (10.14)	4.55 (10.03)	4.05 (8.93)	3.75 (8.27)	3.40 (7.5)	3.05 (6.72)	2.90 (6.39)	
22 (72'2")	3.75 (8.27)	3.95 (8.71)	3.95 (8.71)	23.0m×3.80 (75'6"×8.38)	3.65 (8.05)	3.30 (7.28)	2.95 (6.5)	2.80 (6.17)	
24 (78'9")	3.40 (7.5)	3.45 (7.61)	3.45 (7.61)	3.55 (7.83)	3.50 (7.72)	3.10 (6.83)	2.90 (6.39)	2.70 (5.95)	
26 (85'4")	2.95 (6.5)	3.05 (6.72)	3.05 (6.72)	3.15 (6.94)	3.05 (6.72)	27.7m×2.90 (90'11"×6.39)	2.80 (6.17)	2.60 (5.73)	
28 (91'10")	2.60 (5.73)	2.65 (5.84)	2.70 (5.95)	2.80 (6.17)	2.70 (5.95)	2.85 (6.28)	2.75 (6.06)	2.50 (5.51)	
30 (98'5")	2.30 (5.07)	2.35 (5.18)	2.40 (5.29)	2.45 (5.4)	2.40 (5.29)	2.55 (5.62)	2.45 (5.4)	2.45 (5.4)	
32 (104'12")	2.05 (4.52)	2.05 (4.52)	2.10 (4.63)	2.20 (4.85)	2.15 (4.74)	2.25 (4.96)	2.20 (4.85)	2.30 (5.07)	
34 (111'7")	1.80 (3.97)	1.85 (4.08)	1.85 (4.08)	1.95 (4.3)	1.90 (4.19)	2.00 (4.41)	1.95 (4.3)	2.05 (4.52)	
Counterweight kg(lb)×1000	17.5 (38.6)	17.5 (38.6)	17.5 (38.6)	17.5 (38.6)	17.5 (38.6)	17.5 (38.6)	17.5 (38.6)	17.5 (38.6)	
Main Boom 37m (121'5")									
Jib m (ft)	6.1 (20')		9.15 (30')		12.2 (40')		15.25 (50')		
Jib angle	10°	30°	10°	30°	10°	30°	10°	30°	
Radius m (ft)									
10 (32'10")	11.1m×5.00 (36'5"×11.02)								
12 (39'4")	5.00 (11.02)	12.9m×5.00 (42'4"×11.02)	12.3m×5.00 (40'4"×11.02)		13.4m×4.00 (43'12"×8.82)				
14 (45'11")	5.00 (11.02)	5.00 (11.02)	5.00 (11.02)	15.0m×4.60 (49'3"×10.14)	4.00 (8.82)		14.6m×3.20 (47'11"×7.05)		
16 (52'6")	5.00 (11.02)	5.00 (11.02)	5.00 (11.02)	4.50 (9.92)	4.00 (8.82)	17.0m×3.65 (55'9"×8.05)	16.8m×3.20 (55'1"×7.05)		
18 (59'1")	18.4m×5.00 (60'4"×11.02)	18.6m×5.00 (61'0"×11.02)	18.6m×5.00 (61'0"×11.02)	4.30 (9.48)	3.85 (8.49)	3.60 (7.94)	3.15 (6.94)	19.1m×3.05 (62'8"×6.72)	
20 (65'7")	4.40 (9.7)	4.50 (9.92)	4.45 (9.81)	4.15 (9.15)	3.75 (8.27)	3.45 (7.61)	3.05 (6.72)	2.95 (6.5)	
22 (72'2")	3.80 (8.38)	3.90 (8.6)	3.85 (8.49)	4.00 (8.82)	3.65 (8.05)	3.30 (7.28)	2.95 (6.5)	2.85 (6.28)	
24 (78'9")	3.30 (7.28)	3.40 (7.5)	3.35 (7.39)	3.50 (7.72)	3.40 (7.5)	3.20 (7.05)	2.90 (6.39)	2.75 (6.06)	
26 (85'4")	2.85 (6.28)	2.95 (6.5)	2.95 (6.5)	3.10 (6.83)	3.00 (6.61)	26.6m×3.05 (87'3"×6.72)	2.80 (6.17)	2.65 (5.84)	
28 (91'10")	2.50 (5.51)	2.60 (5.73)	2.60 (5.73)	2.70 (5.95)	2.60 (5.73)	2.80 (6.17)	2.65 (5.84)	2.60 (5.73)	
30 (98'5")	2.20 (4.85)	2.30 (5.07)	2.30 (5.07)	2.40 (5.29)	2.30 (5.07)	2.45 (5.4)	2.35 (5.18)	2.50 (5.51)	
32 (104'12")	1.90 (4.19)	2.00 (4.41)	2.00 (4.41)	2.10 (4.63)	2.05 (4.52)	2.20 (4.85)	2.10 (4.63)	2.20 (4.85)	
34 (111'7")	1.65 (3.64)	1.75 (3.86)	1.75 (3.86)	1.85 (4.08)	1.80 (3.97)	1.90 (4.19)	1.85 (4.08)	2.00 (4.41)	
Counterweight kg(lb)×1000	17.5 (38.6)	17.5 (38.6)	17.5 (38.6)	17.5 (38.6)	17.5 (38.6)	17.5 (38.6)	17.5 (38.6)	17.5 (38.6)	

Notes: 1. The actual lifting capacity is the value that rated lifting capacity in the table deducting the weight of hook block and other lifting tools, but the crane is not allowed to operate when the deducted value is less than 800kg(1,760lb).

2. Cells framed and 25% grayed indicate that the load value depends on the strength of boom system.

Load Charts of FJ Operating Condition

Fixed Jib Load Charts 4/4									kg(lb)×1000
Main Boom 40m (131'3")									
Jib m (ft)	6.1 (20')		9.15 (30')		12.2 (40')		15.25 (50')		
Jib angle	10°	30°	10°	30°	10°	30°	10°	30°	
Radius m (ft)									
10 (32'10")	11.8m×5.00 (38'9"×11.02)								
12 (39'4")	5.00 (11.02)	13.6m×5.00 (44'7"×11.02)	12.9m×5.00 (42'4"×11.02)						
14 (45'11")	5.00 (11.02)	5.00 (11.02)	5.00 (11.02)	15.6m×4.60 (51'2"×10.14)	14.8m×4.00 (48'7"×8.82)		15.2m×3.20 (49'10"×7.05)		
16 (52'6")	5.00 (11.02)	5.00 (11.02)	5.00 (11.02)	4.55 (10.03)	4.00 (8.82)		16.8m×3.20 (55'1"×7.05)		
18 (59'1")	18.1m×5.00 (59'5"×11.02)	18.5m×5.00 (60'8"×11.02)	18.4m×5.00 (60'4"×11.02)	4.35 (9.59)	3.85 (8.49)	3.65 (8.05)	3.15 (6.94)	19.7m×3.05 (64'8"×6.72)	
20 (65'7")	4.30 (9.48)	4.45 (9.81)	4.30 (9.48)	21.6m×4.10 (70'10"×9.04)	3.75 (8.27)	3.50 (7.72)	3.05 (6.72)	3.00 (6.61)	
22 (72'2")	3.70 (8.16)	3.80 (8.38)	3.75 (8.27)	3.95 (8.71)	3.65 (8.05)	3.40 (7.5)	2.95 (6.5)	2.90 (6.39)	
24 (78'9")	3.20 (7.05)	3.30 (7.28)	3.25 (7.16)	3.45 (7.61)	3.30 (7.28)	25.4m×3.20 (83'4"×7.05)	2.90 (6.39)	2.80 (6.17)	
26 (85'4")	2.75 (6.06)	2.85 (6.28)	2.85 (6.28)	3.00 (6.61)	2.90 (6.39)	3.10 (6.83)	2.80 (6.17)	2.70 (5.95)	
28 (91'10")	2.40 (5.29)	2.45 (5.4)	2.45 (5.4)	2.60 (5.73)	2.55 (5.62)	2.70 (5.95)	2.60 (5.73)	2.60 (5.73)	
30 (98'5")	2.10 (4.63)	2.15 (4.74)	2.15 (4.74)	2.30 (5.07)	2.20 (4.85)	2.40 (5.29)	2.25 (4.96)	2.45 (5.4)	
32 (104'12")	1.80 (3.97)	1.85 (4.08)	1.85 (4.08)	2.00 (4.41)	1.90 (4.19)	2.10 (4.63)	1.95 (4.3)	2.20 (4.85)	
34 (111'7")	1.55 (3.42)	1.60 (3.53)	1.60 (3.53)	1.70 (3.75)	1.65 (3.64)	1.80 (3.97)	1.70 (3.75)	1.90 (4.19)	
Counterweight kg(lb)×1000	17.5 (38.6)	17.5 (38.6)	17.5 (38.6)	17.5 (38.6)	17.5 (38.6)	17.5 (38.6)	17.5 (38.6)	17.5 (38.6)	
Main Boom 43m (141'1")									
Jib m (ft)	6.1 (20')		9.15 (30')		12.2 (40')		15.25 (50')		
Jib angle	10°	30°	10°	30°	10°	30°	10°	30°	
Radius m (ft)									
12 (39'4")	12.4m×5.00 (40'8"×11.02)		13.5m×5.00 (44'3"×11.02)						
14 (45'11")	5.00 (11.02)	14.2m×5.00 (46'7"×11.02)	5.00 (11.02)		14.7m×4.00 (48'3"×8.82)		15.8m×3.20 (51'10"×7.05)		
16 (52'6")	5.00 (11.02)	5.00 (11.02)	5.00 (11.02)	16.2m×4.60 (53'2"×10.14)	4.00 (8.82)		16.8m×3.20 (55'1"×7.05)		
18 (59'1")	5.00 (11.02)	18.4m×5.00 (60'4"×11.02)	18.3m×5.00 (60'0"×11.02)	4.45 (9.81)	3.85 (8.49)	19.3m×3.65 (63'4"×8.05)	3.15 (6.94)		
20 (65'7")	4.25 (9.37)	4.40 (9.7)	4.30 (9.48)	21.2m×4.20 (69'7"×9.26)	3.75 (8.27)	3.60 (7.94)	3.05 (6.72)	20.3m×3.05 (66'7"×6.72)	
22 (72'2")	3.65 (8.05)	3.75 (8.27)	3.70 (8.16)	3.95 (8.71)	3.65 (8.05)	3.45 (7.61)	2.95 (6.5)	2.95 (6.5)	
24 (78'9")	3.15 (6.94)	3.25 (7.16)	3.20 (7.05)	3.40 (7.5)	3.20 (7.05)	24.8m×3.30 (81'4"×7.28)	2.90 (6.39)	2.85 (6.28)	
26 (85'4")	2.70 (5.95)	2.80 (6.17)	2.80 (6.17)	2.95 (6.5)	2.80 (6.17)	3.00 (6.61)	2.80 (6.17)	2.75 (6.06)	
28 (91'10")	2.35 (5.18)	2.40 (5.29)	2.40 (5.29)	2.55 (5.62)	2.45 (5.4)	2.65 (5.84)	2.50 (5.51)	2.70 (5.95)	
30 (98'5")	2.00 (4.41)	2.10 (4.63)	2.10 (4.63)	2.25 (4.96)	2.10 (4.63)	2.30 (5.07)	2.15 (4.74)	2.40 (5.29)	
32 (104'12")	1.70 (3.75)	1.80 (3.97)	1.80 (3.97)	1.95 (4.3)	1.80 (3.97)	2.00 (4.41)	1.85 (4.08)	2.10 (4.63)	
34 (111'7")	1.45 (3.2)	1.50 (3.31)	1.55 (3.42)	1.65 (3.64)	1.55 (3.42)	1.70 (3.75)	1.60 (3.53)	1.90 (4.19)	
Counterweight kg(lb)×1000	17.5 (38.6)	17.5 (38.6)	17.5 (38.6)	17.5 (38.6)	17.5 (38.6)	17.5 (38.6)	17.5 (38.6)	17.5 (38.6)	

Notes: 1. The actual lifting capacity is the value that rated lifting capacity in the table deducting the weight of hook block and other lifting tools, but the crane is not allowed to operate when the deducted value is less than 800kg(1,760lb).

2. Cells framed and 25% grayed indicate that the load value depends on the strength of boom system.

