

Grove RT765E- 2

Product Guide



60 t



33,5 m



10,1 - 17,1 m



65,2 m



**Rough Terrain Crane • Geländekran
Grue Tout-Terrain • Grúa Todo Terreno
Autogru Fuoristrada • Grua RT**

Кран для использования на пересеченной местности

Features • Besonderheiten • Caractéristiques Características • Caratteristiche • Características • Особенности

- **MEGAFORM™ boom** - The Grove MEGAFORM™ boom shape eliminates weight and increases capacity compared to conventional shapes. Large wear pads provide superior boom alignment when telescoping, and allow an excellent transition of weights between sections.
- **MEGAFORM™ Ausleger** - Grove Durch das spezielle Design des MEGAFORM™-Auslegers kann im Vergleich zu konventionellen Auslegern Gewicht eingespart und Leistung gesteigert werden. Große Verschleißpolster sorgen für eine optimale Ausrichtung des Auslegers beim Ausfahren und ermöglichen eine ausgezeichnete Verteilung des Gewichts zwischen den Sektionen.
- **Flèche MEGAFORM™** - La forme de la flèche Grove MEGAFORM™ réduit le poids et augmente la capacité par rapport aux formes conventionnelles. Les grandes plaques d'usure optimisent l'alignement de la flèche lors du télescopage et permettent une excellente répartition des charges entre les sections.
- **Pluma MEGAFORM™** - La pluma con forma Grove MEGAFORM™ reduce peso y aumenta la capacidad en comparación con las formas convencionales. Las grandes placas de desgaste proporcionan una mejor alineación de la pluma durante la extensión y permiten una excelente transición de pesos entre las secciones.
- **Braccio MEGAFORM™** - La sezione del braccio Grove MEGAFORM™ riduce il peso e aumenta la capacità rispetto alle configurazioni convenzionali. I pattini di scorrimento di grandi dimensioni garantiscono un allineamento del braccio telescopico di livello superiore e consentono una transizione eccellente dei pesi tra le sezioni.
- **Lança MEGAFORM™** - A forma MEGAFORM™ das lanças Grove proporciona uma redução de peso e um aumento de capacidade quando comparado com as formas tradicionais. As grandes placas de desgaste fornecem um melhor alinhamento da lança quando da telescopagem, permitindo uma excelente repartição dos pesos entre as seções.
- **Кран на вседорожном шасси MEGAFORM™ boom** - The Grove Модель MEGAFORM™ boom снижает вес и увеличивает грузоподъемность по сравнению с другими моделями. Большой я поворотный опор обеспечивает идеальное выравнивание стрелы во время юстировки и превосходное перемещение грузов между секциями.



- **Extensions** - An optional bi-fold swingaway lattice extension easily stows on the side of the base boom for easy transport while providing on-board extension from 10,1 m - 17,1 m for a maximum tip height of 53,2 m. By adding inserts of 6,1 m or 12,2 m, the maximum tip height on the RT765E-2 can be extended even further to 59,1 m or 65,0 m.
- **Verlängerungen** - Eine optionale hochklappbare Verlängerung lässt sich zum einfachen Transport problemlos an der Seite des Auslegers anbringen und ermöglicht es, den Ausleger zwischen 10,1 m und 17,1 m weiter auszufahren, wodurch sich seine maximale Höhe auf 53,2 m erhöht. Durch das Anbringen zusätzlicher Einsatzstücke von entweder 6,1 m oder 12,2 m lässt sich die beim Modell RT765E-2 die maximale Höhe des Auslegers sogar noch auf 59,1 m oder 65,0 m steigern.
- **Extensions** - Une extension treillis à double repliage qui se range facilement le long de l'élément de flèche de base pour un transport aisé tout en fournissant un extension embarquée de 10,1 m à 17,1 m pour une hauteur maximale d'extension du treillis de 53,2 m. En ajoutant des éléments intermédiaires de 6,1 m ou 12,2 m, la hauteur maximale de l'extension treillis de la RT765E-2 peut même être portée à 59,1 m ou 65,0 m.
- **Extensiones** - El plumín opcional de celosía, abatible y articulado en 2 secciones se aloja de forma sencilla al lado de la pluma para trasladarlo fácilmente a la vez que aporta una extensión de 10,1 m a 17,1 m para alcanzar una altura máxima en punta de 53,2 m. Mediante la adición de secciones de 6,1 m o 12,2 m, la altura máxima en punta de la RT765E-2 se puede ampliar incluso hasta 59,1 m o 65,0 m.
- **Prolunghe** - Il falcone tralicciato ripieghevole si ripone facilmente sul lato del braccio telescopico per un facile trasporto, fornendo un'estensione da 10,1 m a 17,1 m per un'altezza massima in punta 53,2 m. Con l'aggiunta di elementi intermedi supplementari da 6,1 m o 12,2 m, l'altezza massima in punta sulla RT765E-2 può essere ulteriormente estesa a 59,1 m o 65,0 m.
- **Extensão** - Uma extensão dupla, treliçada e articulada (opcional) aloja-se facilmente na parte lateral da lança facilitando o seu transporte, enquanto permite o transporte com a grua de uma extensão de 10,1 m – 17,1 m, permitindo alcançar uma altura máxima à ponta de 53,2 m. Adicionando extensões de 6,1 m ou de 12,2 m, a altura máxima à ponta da RT765E-2 pode ser aumentada até 59,1 m ou 65 m.
- **Удлинение стрелы** - опциональное двухсекционное поворотное решетчатое удлинение стрелы легко укладывается с грузом со стороны основания стрелы, что делает перемещение грузов простым, обеспечивая передвижение стрелы от 10,1 м до 17,1 м до максимальной высоты конца стрелы в 53,2 м. Добавлением вставок в 6,1 м или 12,2 м к основной высоте до конца стрелы RT765E-2 может быть увеличена до 59,1 м или 65,0 м соответственно.

- **Full vision cab** - New full-vision cab, all-steel fabricated with acoustical lining and tinted safety glass throughout. Easy and safe to access.
- **Kabine mit Rundumsicht** - Neue Fahrerkabine mit Rundumsicht, komplett aus Stahl mit Lärmschutzisolierung und mit rundum getöntem Sicherheitsglas. Einfacher und sicherer Zugang.
- **Cabine panoramique** - Nouvelle cabine panoramique tout acier, fabriquée avec une isolation sonore et un vitrage teinté de sécurité sur tout le pourtour. Accès facile et sûr.
- **Cabina de visión panorámica** - Nueva cabina de visión panorámica, fabricada totalmente en acero con revestimiento acústico y cristal de seguridad completamente tintado. Acceso fácil y seguro.
- **Cabina "Full Vision"** - Nuova cabina ad ampia visibilità, completamente realizzata in acciaio con rivestimento acustico e vetri di sicurezza colorati. Accesso facile e sicuro.
- **Cabina panorámica** - Nova cabina panorámica, que permite uma visibilidade completa, fabricada integralmente em aço com isolamento acústico e vidro de segurança colorido. Acesso fácil e seguro.
- **Кабина с круговым обзором** - Новая цельностальная кабина с круговым обзором, со звукоизоляционной обивкой и затемненным небьющимся стеклом по всему периметру. Легкий и безопасный доступ к кабине.



Features • Besonderheiten • Caractéristiques Características • Caratteristiche • Características • Особенности

- **Inverted outrigger jacks:** allows to protect the cylinder rod from sand, dust, oils and various elements you can find on a jobsite and increases seal life. The outriggers can be spread in 3 different positions: fully retracted, 50 % and 100 % open.
- **innen liegende Abstützylinder:** schützt die Zylinderstange vor Sand, Staub, Öl und verschiedenen anderen Einflüssen auf der Baustelle. Die Abstützträger können in 3 Stellungen fixiert werden: Voll eingefahren, 50 % und 100 %.
- **Système de calage inversé :** permet de protéger la tige de vérin du sable, de la poussière, de la graisse et de tout autre élément courant sur un site de chantier. Le système de calage peut être placé dans 3 positions : entièrement rentré, 50 % et 100 %.
- **Estabilizadores invertidos:** permite proteger el vástago del cilindro, de la arena, el polvo, aceites y diversos elementos que se pueden encontrar en el lugar de trabajo. Los estabilizadores se pueden fijar en 3 posiciones diferentes: Totalmente plegados, 50% y 100%.
- **Stabilizzatori a steli rovesciati:** consentono di proteggere lo stelo del cilindro dagli urti oltre che dalla sabbia, polvere, olio e vari elementi tipici dei cantieri. Gli stabilizzatori possono essere estesi in 3 configurazioni diverse: Completamente retratti, 50% e 100%.
- **Estabilizadores invertidos:** permite proteger a haste do cilindro da areia, do pó, dos óleos e dos vários elementos que se podem encontrar num local de trabalho. Os estabilizadores podem ser fixos em 3 posições diferentes: totalmente fechados, abertos a 50% e abertos a 100%.
- **Перевернутые цилиндры опор:** способствуют защите штока цилиндра от попадания пыли и прочих веществ, имеющихся на рабочем месте. Выносные опоры можно установить в 3 различных положениях: выдвинув полностью, на 50% или 100%.



- **Tier IV / Euromot 3B compliant engine:** cranes are equipped with engines that meet emissions per U.S.E.P.A. Tier IV and E.U. Stage 3B; engines Tier III / Euromot 3A are available for sales outside of European Union and North American countries.
- **Emissionswerte gemäß Tier IV/Euromot 3B:** Die Krane sind mit Motoren ausgerüstet, die die Emissionsvorgaben der Verordnungen U.S.E.P.A. Tier IV bzw. E.U. Stage 3B erfüllen; Motoren mit Emissionswerten gemäß Tier III bzw. Euromot 3A werden außerhalb Europas und Nordamerikas vertrieben.
- **Moteur conforme à Tier IV / Euromot 3B :** les grues sont équipées de moteurs respectant les exigences en matière d'émissions selon l'U.S.E.P.A. Tier IV et E.U. Phase 3B ; les moteurs Tier III / Euromot 3A sont disponibles à la vente hors de l'Union européenne et des pays d'Amérique du Nord.
- **Motor conforme a los estándares Tier IV / Euromot 3B:** las grúas cuentan con motores que cumplen las normativas de emisiones contaminantes Tier IV de la U.S.E.P.A. y Fase 3B de la U.E.; Se dispone de motores Tier III / Euromot 3A para venta fuera de la Unión Europea y Norteamérica.
- **Motore conforme Tier IV i / Euromot 3B:** le autogrú sono equipaggiate con motori conformi alla normativa Tier IV Interim (U.S.A.) / Euromot 3B (C.E.); i motori Tier III / Euromot 3A sono disponibili per vendita al di fuori dell'Unione Europea e dei paesi del Nord America.
- **Motor em conformidade com Tier IV / Euromot 3B:** as gruas estão equipadas com motores que respeitam as emissões de acordo com Tier IV da USEPA e Classe III B da UE; os motores Tier III / Euromot 3A estão disponíveis para venda fora da União Europeia e países da América do Norte.
- **Двигатель типа Tier IV / Euromot 3B, отвечающий применимым экологическим требованиям:** краны оснащены двигателями, удовлетворяющими требованиям по выбросам U.S.E.P.A. Tier IV и E.U. Stage 3B; двигатели типа Tier III / Euromot 3A продаются вне Европейского Союза и стран Северной Америки.

CraneSTAR
EQUIPPED

- **CraneSTAR** is an exclusive and innovative crane asset management system that helps improve your profitability and reduce costs by remotely monitoring critical crane data. Visit www.cranestar.com for more information.
- **CraneSTAR** ist ein exklusives und innovatives Kran-Anlagegüterverwaltungssystem, das Ihnen hilft, auch außerhalb Ihres Büros wichtige Krandaten abzurufen und somit Ihre Profitabilität zu steigern und Kosten zu reduzieren. Mehr Informationen unter www.cranestar.com.
- **CraneSTAR** est un système exclusif et innovant de gestion de parc de grues qui contribue à améliorer la rentabilité et à réduire les coûts en surveillant à distance les données cruciales des grues. Visitez www.cranestar.com plus de plus amples informations.
- **CraneSTAR** es un sistema exclusivo e innovador de gestión de flotas de grúas que ayuda a mejorar la rentabilidad y reducir los costes controlando a distancia los datos críticos de la grúa. Más información en www.cranestar.com
- **CraneSTAR** è un esclusivo e innovativo sistema di gestione del parco mezzi che aiuta a migliorare la redditività e ridurre i costi attraverso il monitoraggio remoto dei dati critici dell'autogrú. Visitare il sito www.cranestar.com per ulteriori informazioni.
- **CraneSTAR** é um sistema exclusivo e inovador de gestão de frotas de gruas que ajuda a melhorar a sua rentabilidade e a reduzir os custos ao monitorizar à distância os dados importantes da grua. Mais informação em www.cranestar.com.
- **CraneSTAR** - это эксклюзивная инновационная система управления ресурсом подъемного крана, которая позволяет увеличить производительность и сократить расходы путем постоянного дистанционного наблюдения за критическими данными подъемного крана. Посетите сайт www.cranestar.com для получения дополнительной информации.

Contents • Inhalt • Contenu • Contenido Contenuto • Содержание

Features • Besonderheiten • Caractéristiques • Caratteristiche • Características • Características • Осоюенноти	2
Dimensions • Abmessungen • Encombrement • Dimensiones • Dimensioni • Dimensões • Размеры	5
Weight • Gewicht • Poids • Peso • Peso • Peso • Вес	6
Data • Daten • Caractéristiques • Datos • Dati • Características • Данные	7
Load charts • Traglasten • Capacités de levage • Capacidades • Capacità • Diagramas de carga Таблицы грузоподъемности	
Notes • Hinweise • Notes • Notas • Note • Notas • Примечания	8
Working Range • Arbeitsbereiche • Diagramme de levage • Gama de trabajo • Area di lavoro Area de trabalho • Грузовысотные характеристики	9
Telescopic Boom • Teleskopausleger • Flèche principale • Pluma telescópica • Braccio telescopico Lança telescópica • Телескопическая стрела	10
Swingaway • Klappspitze • Extension treillis • Plumín • Jib • Jib • Откидной удлинитель стрелы	15
Specifications	19
Technische Daten	20
Caractéristiques techniques	21
Características técnicas	22
Caratteristiche tecniche	23
Características técnicas	24
Технические характеристики	25
Notes • Hinweise • Notes • Notas • Note • Notas • Примечания	26
Symbols • Symbolerklärung • Glossaire des symboles • Glosario de simbolos Glossario dei simboli • Símbolos • Символы	27



Manitowoc Crane Care is the Manitowoc's unparalleled product support organisation. Manitowoc Crane Care combines all aspects of parts, service, technical documentation, technical support and training into one organisation. The program includes all of the Manitowoc's brands, which include, Potain, Grove, Manitowoc and National Crane.

For the care of your crane and the prosperity of your business, Manitowoc Crane Care is your single source for customer support. Wherever, whenever, whatever – we're there.

Manitowoc Crane Care vereint alle Serviceleistungen von Manitowoc im Produktsupport vor und nach dem Verkauf: Ersatzteile, Service, technische Dokumentation, technischer Support und Schulung, alles unter einem Dach. Dieser Service erstreckt sich auf alle Marken von Manitowoc: Potain, Grove, Manitowoc und National Crane.

Damit Ihr Kran leistungsfähig bleibt und Ihr Erfolg gesichert ist, bietet Ihnen Manitowoc Crane Care einen umfassenden Support aus einer Hand. Zu jeder Zeit, an jedem Ort, für jeden Fall – wir sind für Sie da.

Organisation hors pair dédiée au support technique des produits de Manitowoc, Manitowoc Crane Care réunit au sein d'une même entité tous les aspects du service : pièces de rechange, service après-vente, publication technique, assistance technique et formation. Ce programme s'adresse à toutes les marques de Manitowoc : Potain, Grove, Manitowoc et National Crane.

Para assegurar a manutenção cuidada das suas gruas e a prosperidade do seu negócio, o seu único interlocutor do serviço de clientes é a Manitowoc Crane CARE. Esteja onde estiver, sejam as horas que forem, precise do que precisar, pode sempre contar conosco!

Pour assurer l'entretien de vos grues et la prospérité de votre entreprise, Manitowoc Crane Care constitue votre unique interlocuteur du service à la clientèle. Où que vous soyez, quel que soit votre besoin, vous pouvez toujours compter sur nous !

Manitowoc Crane Care, es la organización de post-venta y soporte técnico de Manitowoc. Manitowoc Crane Care combina todos los aspectos relacionados con piezas de repuesto, servicio, documentación técnica, apoyo técnico y formación en una sola organización. El programa también incluye todas las marcas que Manitowoc engloba: Potain, Grove, Manitowoc y National Crane.

Para el cuidado de su grúa y la prosperidad de su negocio, Manitowoc Crane Care, es la forma más sencilla de ayudarle. Donde sea y cuando sea, nosotros estamos allí.

Manitowoc Crane Care è l'ineguagliabile organizzazione di supporto di Manitowoc. Manitowoc Crane Care gestisce tutte le attività legate a pezzi di ricambio, documentazione tecnica, assistenza tecnica e formazione riunite in un unico punto di riferimento. Questo servizio è attivo per tutti i marchi di Manitowoc e precisamente Potain, Grove, Manitowoc e National Crane.

Per l'assistenza delle Vostre gru e per la redditività dei Vostri investimenti, Manitowoc Crane Care è l'insostituibile Vostra risorsa. In ogni posto, tutte le volte, per qualsiasi necessità – noi ci siamo

Organização verdadeiramente impar dentro da Manitowoc Crane Group, é a Manitowoc Crane Care que compete a responsabilidade pelo suporte técnico dos nossos produtos. Ela reúne, numa mesma entidade, todos os aspectos do serviço: peças de substituição, serviço pós-venda, documentação técnica, suporte técnico e formação. Este programa abrange todas as marcas do Manitowoc Crane Group: Potain, Grove, Manitowoc e National Crane. Para assegurar a manutenção cuidada das suas gruas e a prosperidade do seu negócio, o seu único interlocutor do serviço de clientes é a Manitowoc Crane CARE. Esteja onde estiver, sejam as horas que forem, precise do que precisar, pode sempre contar conosco!

Manitowoc Crane Care - это не имею я и логов орг низ ция, входящ я в Manitowoc и осуществляющ я техническую поддержку продукции. Manitowoc Crane Care з ним ется всеми спект ми, связ нными с з п сными ч стями, услуг ми, технической документ цией, технической поддержкой и обучением. Прогр мм включ ет все торговые м рки Manitowoc, в том числе, Potain, Grove, Manitowoc и National Crane.

Manitowoc Crane Care является единой точкой конт ктов для всех клиентов комп нии, где они могут получить полное обслужив ние для используемых ими кр нов, что, в свою очередь, обеспечит процвет ние их бизнес . Мы всегд т ми в тот момент, где и когд мы необходимы.

Dimensions • Abmessungen • Encombremet Dimensiones • Dimensioni • Dimensões • Размеры

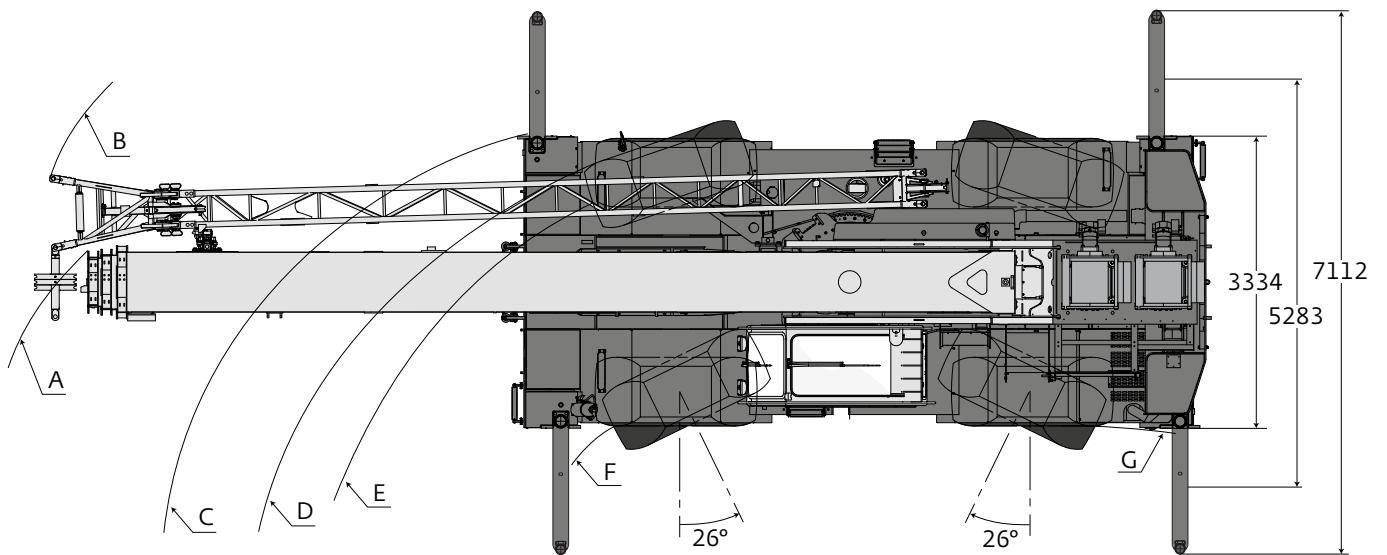
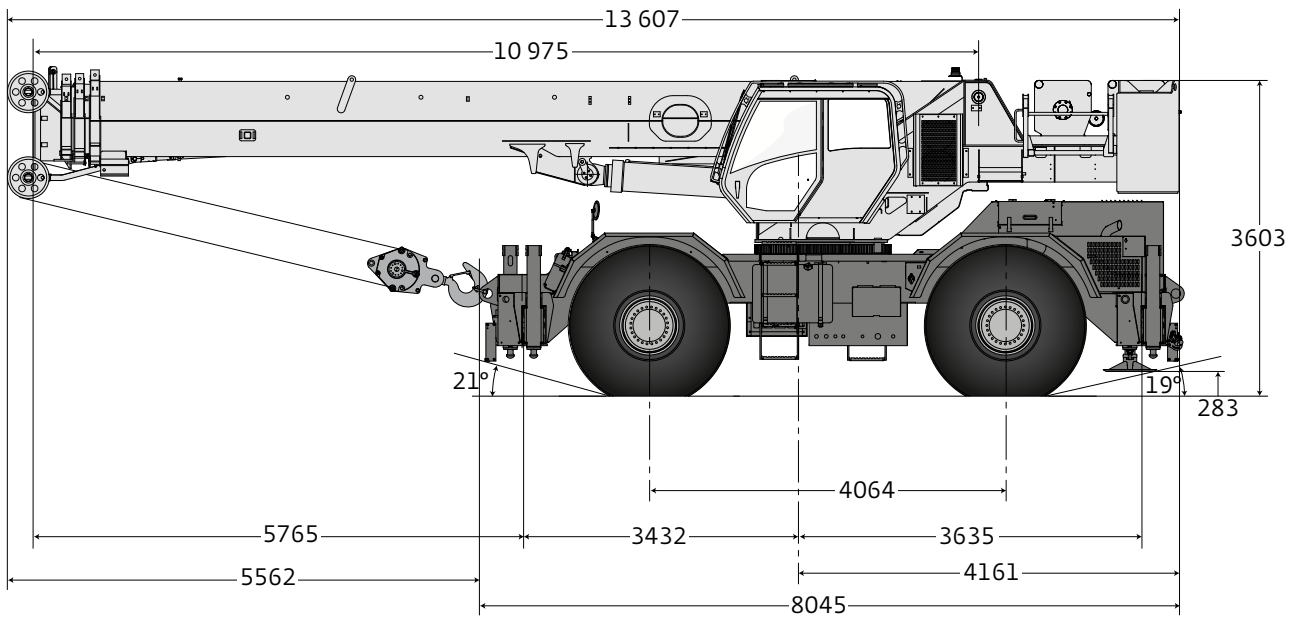

Tire size	A	B	C	D	E	F	G	A	B	C	D	E	F	G	H
29,5-25	14 961	15 368	12 460	11 732	11 342	9 004	7 662	10 922	11 153	7 830	7 099	6 744	4 368	3 496	2 499
	2 wheel steer							4 wheel steer							

Note: Reference dimensions in mm • Hinweis: Bezugsmaße in mm • Remarque : cotes de référence en mm • Nota: Dimensiones de referencia en mm • Nota: Dimensioni di riferimento in mm • Nota: Dimensões de referência em mm • Примечание: Справочные размеры (в мм)

Weight • Gewicht • Poids • Peso Peso • Peso • Bec



Axle Achse Essieu Eje Asse Eixo Оси	Total weight Gesamtgewicht Poids total Peso total Peso totale Peso total Суммарный вес	Front Vorne Avant Delantero Anteriore Dianteiro Передняя	Rear Hinten Arrière Trasero Posteriore Traseiro Задняя
	kg	kg	kg
<ul style="list-style-type: none"> • Basic machine including 33,5 m main boom, main hoist with 152 m of wire rope, auxiliary hoist with 152 m of wire rope, full pinned counterweight, full decking, A/C, and hoist access platform • Basismaschine mit 33,5 m Hauptausleger, Hauptwinde mit 152 m Drahtseil, Hilfswinde mit 152 m Drahtseil, voll befestigtes Gegengewicht, Deck über die volle Länge, Klimaanlage und Zugangsplattform zur Winde • Machine de base comportant une flèche principale de 33,5 m, un treuil principal avec 152 m de câble métallique, un treuil auxiliaire avec 152 m de câble métallique, un contrepoids entièrement broché, un platelage complet, air conditionné, et une plateforme d'accès au treuil • Máquina básica que incluye pluma principal de 33,5 m, cabrestante principal con 152 m de cable metálico, cabrestante auxiliar con 152 m de cable metálico, contrapeso completamente anclado, cubierta completa, aire acondicionado y plataforma de acceso al cabrestante • Macchina base comprensiva di braccio principale da 33,5 m, argano principale con 152 m di fune metallica, argano ausiliario con 152 m di fune metallica, contrappeso completo, rivestimento completo, aria condizionata, piattaforma per accesso all'argano • Máquina básica que inclui lança principal de 33,5 m, guincho principal com 152 m de cabo de arame, guincho auxiliar com 152 m de cabo arame, contrapeso completo com pino, piso completo, ar condicionado e plataforma de acesso ao guincho • Базовая машина с 33,5-метровой главной стрелой, главным подъёмником с 152-метровым стальным тросом, дополнительным подъёмником со 152-метровым тросом, полностью закрепленным противовесом, полной платформой, кондиционированием и ремонтной платформой подъёмника. 	40 381	18 495	21 887
<ul style="list-style-type: none"> • Add: 10,1 - 17,1 m bi-fold swingaway, extension carrier brackets, aux. boom nose <ul style="list-style-type: none"> • Hinzufügen: 10,1 - 17,1 m hochklappbare Verlängerung, Befestigungsklammern für Verlängerung, zusätzlicher Auslegerkopf • Ajouter : 10,1 - 17,1 m extension à double repliage, consoles de support de l'extension, tête de flèche auxiliaire • Añadir: plumín articulado en 2 secciones de 10,1 a 17,1 m + soportes del plumín, punta de pluma auxiliar • Aggiungere: falcone ripieghevole di 10,1 - 17,1 m, staffe di supporto del traliccio, testa braccio ausiliaria • Adicionar: Extensão dupla treliçada, articuladas (jib) de 10,1 a 17,1 m + suportes de apoio do jib, nariz de lança auxiliar • Дополнительно: 10,1 м - 17,1м двухсекционное поворотное удлинение, кронштейны удлинения, вспомогательным наконечником стрелы 	1 265	1 997	- 732
Total weight • Gesamtgewicht • Poids total • Peso total • Peso totale • Peso total • Суммарный вес	41 646	20 491	21 155
<ul style="list-style-type: none"> • Add: 60 t 5-sheave hook block stowed in through • Hinzufügen: 60 t Hakenflasche mit 5 integrierten Seilrollen • Ajouter : bloc de crochet intégré 60 t à 5 poulies • Añadir: bloque de gancho integrado con 5 poleas de 60 t <ul style="list-style-type: none"> • Aggiungere: gancio a 5 pulegge da 60 t • Adicionar: bloco de gancho integrado de 5 roldanas de 60 t • Дополнительно: 60-тонный 5-шкивный интегрированный крюкоблок 	480	480	0
Total weight • Gesamtgewicht • Poids total • Peso total • Peso totale • Peso total • Суммарный вес	42 227	21 072	21 155
<ul style="list-style-type: none"> • Add: 7,5 t headache ball • Hinzufügen: 7,5 t Drallfänger • Ajouter : boule de démolition de 7,5 t • Añadir: gancho de bola de 7,5 t • Aggiungere: gancio a palla da 7,5 t • Adicionar: gancho de bola 7,5 t <ul style="list-style-type: none"> • Дополнительно: 7,5-тонная шаровая баба 	161	262	- 101
Total weight • Gesamtgewicht • Poids total • Peso total • Peso totale • Peso total • Суммарный вес	42 388	21 334	21 053



Lifting Capacity Traglast Force de levage Capacidad de elevación Capacità di sollevamento Capacidade de elevação Грузоподъемность	Sheaves Rollen Poulies Poleas Carrucolo Roldanas Шкивы	Parts of line Stränge Brins Ramales de cable Numero di funi Partes de cabo Кратность запасовки	Total weight Gesamtgewicht Poids total Peso total Peso totale Peso total Суммарный вес
60 t	5	9	580 kg
7,5 t	H/B (swivel)	1	161 kg



	Infinitely variable Stufenlos Progressivement variable Infinitamente variable Infinitamente variabile Infinitamente variável Плавно-изменяемый	Rope Seil Câble Cable Fune Cabo Канат	Permissible line pull max. Max. Seilzug Effort maxi au brin Tracciones del cable admisibles Trazioni ammissibili della linea Esforço máx. admissível no cabo Максимально допустимое натяжение каната	Nominal cable length Seillänge (Nennwert) Longueur nominale des cables Longitud nominal del cable Lunghezza nominale cavo Comprimento nominal de cabo Номинальная длина каната
	0 - 156 m/min single line / bei einfachem Strang brin simple / ramal simple tiro a fune singola / cabo singelo Однократная запасовка	19 mm (6x37 class)	7 620 kg	152 m
	0 - 156 m/min single line / bei einfachem Strang brin simple / ramal simple tiro a fune singola / cabo singelo Однократная запасовка	19 mm (35x7 class)	7 620 kg	152 m
	0 - 2,5 min ⁻¹			
	-3° / + 78° approx. 42 s ca. 42 s • env. 42 s aproximadamente 42 s circa 42 s • cerca de 42 s примерно 42 с			
	11,0 m - 33,5 m approx. 61 s ca. 61 s • env. 61 s aproximadamente 61 s circa 61 s • cerca de 61 s примерно 61 с			

Load charts • Traglasten • Capacités de levage • Capacidades Capacità • Diagramas de carga • Таблицы грузоподъемности

Working range • Arbeitsbereiche • Diagramme de levage • Gama de trabajo • Area di lavoro
Intervalo de funcionamento • Грузовысотные характеристики



11,0 - 33,5 m



100 %



360°



6,5 t

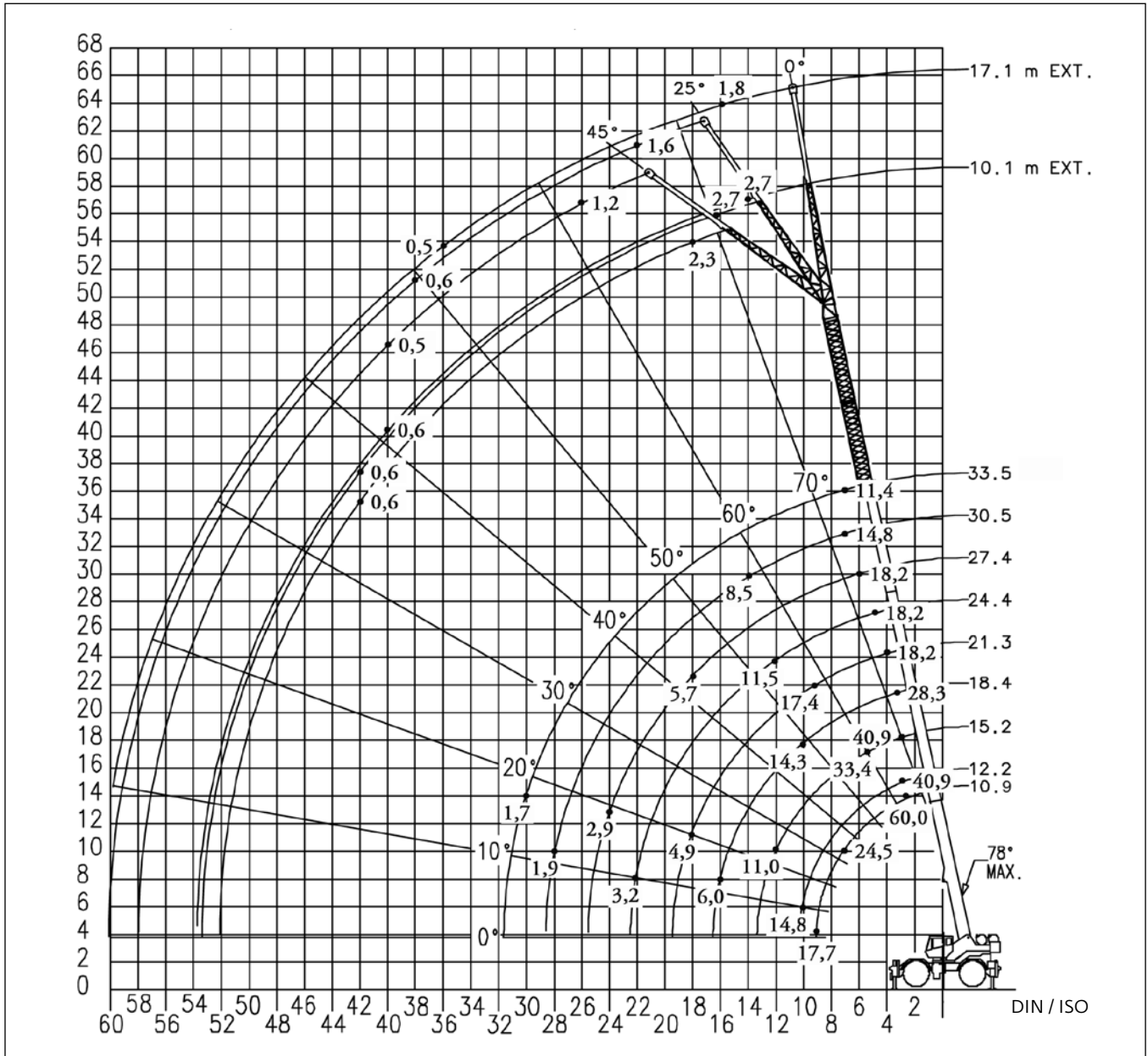

	H (mm) (t)
	2644

Load charts • Traglasten • Capacités de levage • Capacidades Caracità • Diagramas de carga • Таблицы грузоподъемности

Telescopic boom • Teleskopausleger • Flèche principale • Pluma telescópica • Braccio telescopico
Lança telescópica • Телескопическая стрела



11,0 - 33,5 m



100%



360°



6,5 t



DIN/ISO

m	11,0	12,2	15,2	18,4	21,3	24,4	27,4	30,5	33,5	m
2,5	60,000	-	-	-	-	-	-	-	-	2,5
3,0	52,225	40,950	40,950	-	-	-	-	-	-	3,0
3,5	46,300	40,950	40,950	28,350	-	-	-	-	-	3,5
4,0	41,375	40,950	40,700	28,350	18,225	-	-	-	-	4,0
4,5	37,250	37,075	36,650	28,350	18,225	-	-	-	-	4,5
5,0	33,925	33,775	33,400	28,350	18,225	18,225	-	-	-	5,0
6,0	28,450	28,350	28,025	27,675	18,225	18,225	18,225	-	-	6,0
7,0	24,500	24,400	24,100	23,825	18,225	18,225	16,875	14,800	11,400	7,0
8,0	20,900	20,775	20,425	20,100	18,225	16,900	15,300	13,825	11,400	8,0
9,0	17,725	17,650	17,350	17,075	17,350	15,350	13,725	12,625	11,400	9,0
10,0	-	14,850	14,575	14,325	14,625	13,875	12,575	11,575	10,775	10,0
12,0	-	-	10,975	10,925	11,250	11,475	10,675	9,860	9,205	12,0
14,0	-	-	-	8,090	8,475	8,845	9,215	8,505	7,950	14,0
16,0	-	-	-	5,960	6,400	6,740	6,895	7,005	6,650	16,0
18,0	-	-	-	-	4,860	5,290	5,665	5,785	5,850	18,0
20,0	-	-	-	-	-	4,130	4,540	4,720	4,895	20,0
22,0	-	-	-	-	-	3,220	3,640	3,830	4,000	22,0
24,0	-	-	-	-	-	-	2,905	3,105	3,280	24,0
26,0	-	-	-	-	-	-	-	2,485	2,680	26,0
28,0	-	-	-	-	-	-	-	1,945	2,165	28,0
30,0	-	-	-	-	-	-	-	-	1,710	30,0

80039876



85 %

m	11,0	12,2	15,2	18,4	21,3	24,4	27,4	30,5	33,5	m
3,0	60,000	40,950	40,950	-	-	-	-	-	-	3,0
3,5	53,000	40,950	40,950	28,350	-	-	-	-	-	3,5
4,0	47,450	40,950	40,950	28,350	18,225	-	-	-	-	4,0
4,5	42,875	40,950	40,950	28,350	18,225	-	-	-	-	4,5
5,0	39,050	39,025	38,300	28,350	18,225	18,225	-	-	-	5,0
6,0	32,950	32,925	32,825	28,350	18,225	18,225	18,225	-	-	6,0
7,0	28,325	28,300	28,225	26,250	18,225	18,225	18,225	16,725	11,400	7,0
8,0	24,150	24,150	23,975	23,275	18,225	18,225	16,575	15,250	11,400	8,0
9,0	20,600	20,550	20,375	20,250	18,225	16,575	15,050	13,875	11,400	9,0
10,0	-	17,200	17,300	17,275	17,325	15,125	13,725	12,700	11,400	10,0
12,0	-	-	12,075	12,225	12,575	12,775	11,600	10,725	10,050	12,0
14,0	-	-	-	9,000	9,360	9,730	9,955	9,205	8,620	14,0
16,0	-	-	-	6,755	7,165	7,545	7,920	7,980	7,470	16,0
18,0	-	-	-	-	5,555	5,960	6,340	6,525	6,530	18,0
20,0	-	-	-	-	-	4,755	5,145	5,320	5,495	20,0
22,0	-	-	-	-	-	3,790	4,210	4,380	4,545	22,0
24,0	-	-	-	-	-	-	3,435	3,620	3,780	24,0
26,0	-	-	-	-	-	-	-	2,975	3,150	26,0
28,0	-	-	-	-	-	-	-	2,400	2,620	28,0
30,0	-	-	-	-	-	-	-	-	2,135	30,0

80039615

Load charts • Traglasten • Capacités de levage • Capacidades Capacità • Diagramas de carga • Таблицы грузоподъемности

Telescopic boom • Teleskopausleger • Flèche principale • Pluma telescópica • Braccio telescopico
Lança telescópica • Телескопическая стрела



11,0 - 33,5 m



50%



360°



6,5 t



DIN/ISO

m	10,8	12,2	15,2	18,4	21,3	24,4	27,4	30,5	33,5	m
3,0	52,225	40,950	40,950	-	-	-	-	-	-	3,0
3,5	46,300	40,950	40,950	28,350	-	-	-	-	-	3,5
4,0	41,375	40,950	40,700	28,350	18,225	-	-	-	-	4,0
4,5	37,225	37,075	36,650	28,350	18,225	-	-	-	-	4,5
5,0	33,925	33,775	31,125	28,350	18,225	18,225	-	-	-	5,0
6,0	26,625	25,675	23,550	21,825	18,225	18,225	18,225	-	-	6,0
7,0	20,300	20,175	18,650	17,350	17,050	16,675	16,250	14,800	11,400	7,0
8,0	15,400	15,525	15,225	14,200	14,075	13,850	13,600	13,325	11,400	8,0
9,0	12,050	12,200	12,425	11,825	11,825	11,725	11,575	11,400	11,200	9,0
10,0	-	9,755	10,000	10,000	10,050	10,050	9,970	9,865	9,730	10,0
12,0	-	-	6,705	6,915	7,280	7,585	7,595	7,580	7,525	12,0
14,0	-	-	-	4,790	5,195	5,570	5,910	5,955	5,950	14,0
16,0	-	-	-	3,295	3,710	4,115	4,485	4,675	4,775	16,0
18,0	-	-	-	-	2,610	3,025	3,415	3,610	3,785	18,0
20,0	-	-	-	-	-	2,180	2,580	2,780	2,960	20,0
22,0	-	-	-	-	-	1,515	1,915	2,110	2,295	22,0
24,0	-	-	-	-	-	-	1,375	1,565	1,745	24,0
26,0	-	-	-	-	-	-	-	1,115	1,290	26,0
28,0	-	-	-	-	-	-	-	0,730	0,905	28,0
30,0	-	-	-	-	-	-	-	-	0,580	30,0

80039877



85%

m	11,0	12,2	15,2	18,4	21,3	24,4	27,4	30,5	33,5	m
3,0	56,100	40,950	40,950	-	-	-	-	-	-	3,0
3,5	50,750	40,950	40,950	28,350	-	-	-	-	-	3,5
4,0	46,250	40,950	40,950	28,350	18,225	-	-	-	-	4,0
4,5	42,450	40,950	40,950	28,350	18,225	-	-	-	-	4,5
5,0	39,025	37,750	34,900	28,350	18,225	18,225	-	-	-	5,0
6,0	28,025	27,725	25,850	24,300	18,225	18,225	18,225	-	-	6,0
7,0	20,300	20,400	20,200	19,050	18,225	18,225	18,225	16,725	11,400	7,0
8,0	15,400	15,525	15,675	15,425	15,400	15,300	15,125	14,925	11,400	8,0
9,0	12,050	12,200	12,425	12,475	12,775	12,825	12,750	12,650	11,400	9,0
10,0	-	9,755	10,000	10,125	10,450	10,750	10,925	10,875	10,775	10,0
12,0	-	-	6,705	6,915	7,280	7,615	7,940	8,155	8,260	12,0
14,0	-	-	-	4,790	5,195	5,570	5,910	6,110	6,305	14,0
16,0	-	-	-	3,295	3,710	4,115	4,485	4,675	4,855	16,0
18,0	-	-	-	-	2,610	3,025	3,415	3,610	3,785	18,0
20,0	-	-	-	-	-	2,180	2,580	2,780	2,960	20,0
22,0	-	-	-	-	-	1,515	1,915	2,110	2,295	22,0
24,0	-	-	-	-	-	-	1,375	1,565	1,745	24,0
26,0	-	-	-	-	-	-	-	1,115	1,290	26,0
28,0	-	-	-	-	-	-	-	0,730	0,905	28,0
30,0	-	-	-	-	-	-	-	-	0,580	30,0

80039616

Load charts • Traglasten • Capacités de levage • Capacidades Caracità • Diagramas de carga • Таблицы грузоподъемности

Telescopic boom • Teleskopausleger • Flèche principale • Pluma telescópica • Braccio telescopico
Lança telescópica • Телескопическая стрела



11,0 - 33,5 m



0 %



360°



6,5 t



DIN/ISO

m	10,8	12,2	15,2	18,4	21,3	24,4	27,4	30,5	33,5	m
3,0	34,550	32,825	29,250	-	-	-	-	-	-	3,0
3,5	28,000	26,725	24,050	21,850	-	-	-	-	-	3,5
4,0	23,275	22,350	20,250	18,500	17,825	-	-	-	-	4,0
4,5	19,725	19,025	17,350	15,925	15,450	-	-	-	-	4,5
5,0	16,975	16,400	15,050	13,850	13,550	13,175	-	-	-	5,0
6,0	13,025	12,575	11,625	10,750	10,650	10,475	10,250	-	-	6,0
7,0	9,740	9,865	9,180	8,555	8,590	8,530	8,420	8,285	8,120	7,0
8,0	7,395	7,515	7,365	6,855	7,020	7,040	7,000	6,930	6,830	8,0
9,0	5,675	5,790	5,965	5,535	5,755	5,865	5,875	5,855	5,800	9,0
10,0	-	4,475	4,660	4,480	4,735	4,895	4,960	4,975	4,955	10,0
12,0	-	-	2,765	2,880	3,200	3,410	3,540	3,630	3,655	12,0
14,0	-	-	-	1,585	1,960	2,325	2,500	2,615	2,690	14,0
16,0	-	-	-	0,685	1,035	1,410	1,710	1,845	1,935	16,0
18,0	-	-	-	-	-	0,715	1,085	1,235	1,340	18,0
20,0	-	-	-	-	-	-	0,550	0,740	0,860	20,0

80039878



85 %

m	10,8	12,2	15,2	18,4	21,3	24,4	27,4	30,5	33,5	m
3,0	39,600	37,925	34,425	-	-	-	-	-	-	3,0
3,5	31,450	30,250	27,725	25,600	-	-	-	-	-	3,5
4,0	25,850	24,950	23,000	21,350	18,225	-	-	-	-	4,0
4,5	21,675	21,050	19,475	18,175	17,800	-	-	-	-	4,5
5,0	18,525	18,025	16,775	15,675	15,475	15,175	-	-	-	5,0
6,0	13,125	13,275	12,825	12,025	12,025	11,925	11,750	-	-	6,0
7,0	9,740	9,865	10,050	9,510	9,605	9,610	9,555	9,465	9,340	7,0
8,0	7,395	7,515	7,725	7,605	7,810	7,885	7,890	7,865	7,800	8,0
9,0	5,675	5,790	5,985	6,130	6,405	6,545	6,595	6,615	6,590	9,0
10,0	-	4,475	4,660	4,795	5,130	5,425	5,560	5,610	5,615	10,0
12,0	-	-	2,765	2,880	3,240	3,590	3,915	4,090	4,135	12,0
14,0	-	-	-	1,585	1,960	2,325	2,675	2,875	3,052	14,0
16,0	-	-	-	0,645	1,035	1,410	1,770	1,970	2,160	16,0
18,0	-	-	-	-	-	0,715	1,085	1,280	1,465	18,0
20,0	-	-	-	-	-	-	0,550	0,740	0,925	20,0

80039617

Load charts • Traglasten • Capacités de levage • Capacidades Capacità • Diagramas de carga • Таблицы грузоподъемности

Telescopic boom • Teleskopausleger • Flèche principale • Pluma telescópica • Braccio telescopico
Lança telescópica • Телескопическая стрела



11,0 - 33,5 m



0 km/h



360°



6,5 t



DIN/ISO

m	11,0	12,2	15,2	18,4	21,3	m
3,0	20,525	18,000	-	-	-	3,0
3,5	19,250	18,000	13,425	-	-	3,5
4,0	17,150	16,425	12,875	-	-	4,0
4,5	14,650	14,075	12,100	9,480	-	4,5
5,0	12,225	12,000	11,100	9,480	-	5,0
6,0	8,660	8,510	8,470	7,840	7,825	6,0
7,0	6,410	6,295	6,250	6,120	6,240	7,0
8,0	4,865	4,775	4,685	4,650	4,890	8,0
9,0	3,725	3,665	3,540	3,485	3,785	9,0
10,0	-	2,815	2,665	2,600	2,950	10,0
12,0	-	-	1,415	1,330	1,715	12,0
14,0	-	-	-	-	0,875	14,0

80039887



85 %

m	11,0	12,2	15,2	18,4	21,3	m
3,0	20,525	18,000	-	-	-	3,0
3,5	19,250	18,000	13,425	-	-	3,5
4,0	17,875	17,275	12,875	-	-	4,0
4,5	16,500	16,250	12,100	9,480	-	4,5
5,0	14,175	13,900	11,575	9,480	-	5,0
6,0	10,150	10,000	9,930	9,480	7,845	6,0
7,0	7,630	7,500	7,460	7,350	7,595	7,0
8,0	5,885	5,785	5,695	5,630	5,870	8,0
9,0	4,510	4,405	4,375	4,350	4,625	9,0
10,0	-	3,305	3,280	3,345	3,525	10,0
12,0	-	-	1,810	1,680	2,085	12,0
14,0	-	-	-	-	1,155	14,0

80039623

Load charts • Traglasten • Capacités de levage • Capacidades Caracità • Diagramas de carga • Таблицы грузоподъемности

Telescopic boom • Teleskopausleger • Flèche principale • Pluma telescópica • Braccio telescopico
Lança telescópica • Телескопическая стрела



11,0 - 33,5 m



4 km/h



0°



6,5 t



DIN/ISO

m	11,0	12,2	15,2	18,4	21,3	m
3,0	21,400	19,950	15,400	-	-	3,0
3,5	20,125	19,450	15,400	-	-	3,5
4,0	18,425	18,025	15,400	12,925	-	4,0
4,5	16,550	16,225	15,400	12,925	9,685	4,5
5,0	14,950	14,725	14,425	12,675	9,685	5,0
6,0	12,450	12,275	12,125	12,075	9,685	6,0
7,0	10,575	10,450	10,375	10,425	9,685	7,0
8,0	8,900	8,815	8,825	8,840	9,195	8,0
9,0	7,140	6,885	7,105	7,215	7,610	9,0
10,0	-	5,425	5,680	5,820	6,235	10,0
12,0	-	-	3,680	3,845	4,280	12,0
14,0	-	-	-	2,525	2,955	14,0
16,0	-	-	-	1,580	2,005	16,0
18,0	-	-	-	-	1,295	18,0

80039889



85 %

m	11,0	12,2	15,2	18,4	21,3	m
3,0	21,400	19,950	15,400	-	-	3,0
3,5	20,125	19,450	15,400	-	-	3,5
4,0	18,425	18,025	15,400	12,925	-	4,0
4,5	16,550	16,225	15,400	12,925	9,685	4,5
5,0	14,950	14,725	14,425	12,675	9,685	5,0
6,0	12,450	12,275	12,125	12,075	9,685	6,0
7,0	10,575	10,450	10,375	10,425	9,685	7,0
8,0	8,900	8,825	8,825	8,840	9,195	8,0
9,0	7,535	7,500	7,535	7,550	7,915	9,0
10,0	-	6,425	6,500	6,510	6,895	10,0
12,0	-	-	4,795	4,780	5,215	12,0
14,0	-	-	-	3,490	3,940	14,0
16,0	-	-	-	2,440	2,950	16,0
18,0	-	-	-	-	2,045	18,0

80039624

Load charts • Traglasten • Capacités de levage • Capacidades Capacità • Diagramas de carga • Таблицы грузоподъемности

Swingaway • Klappspitze • Extension treillis • Plumín • Falcone • Jib • Складной удлинитель стрелы



11,0 - 33,5 m



10,1 - 29,2 m



100%



360°



6,5 t



DIN/ISO

m	10,1 m			17,1 m			m
	0°	25°	45°	0°	25°	45°	
9,0	5,860	-	-	-	-	-	9,0
10,0	5,860	-	-	3,085	-	-	10,0
12,0	5,860	4,840	-	3,005	-	-	12,0
14,0	5,855	4,650	3,360	2,925	-	-	14,0
16,0	5,260	4,355	3,215	2,850	2,400	-	16,0
18,0	4,665	3,935	3,100	2,775	2,340	-	18,0
20,0	4,100	3,565	3,005	2,700	2,270	1,750	20,0
22,0	3,710	3,250	2,920	2,625	2,205	1,690	22,0
24,0	3,345	2,980	2,800	2,555	2,090	1,620	24,0
26,0	3,000	2,740	2,610	2,425	2,020	1,560	26,0
28,0	2,500	2,540	2,435	2,195	1,920	1,525	28,0
30,0	2,080	2,325	2,280	2,000	1,770	1,480	30,0
32,0	1,715	1,925	2,000	1,830	1,640	1,460	32,0
34,0	1,390	1,580	-	1,600	1,520	1,425	34,0
36,0	1,110	1,270	-	1,320	1,410	1,350	36,0
38,0	0,860	0,995	-	1,080	1,315	1,270	38,0
40,0	0,640	-	-	0,860	1,090	-	40,0
42,0	-	-	-	0,670	0,855	-	42,0
44,0	-	-	-	-	0,640	-	44,0

80039882

m	23,1 m			29,2 m			m
	0°	25°	45°	0°	25°	45°	
14,0	2,700	-	-	-	-	-	14,0
16,0	2,565	2,655	-	1,810	-	-	16,0
18,0	2,245	2,435	2,345	1,795	-	-	18,0
20,0	1,960	2,180	2,095	1,665	-	-	20,0
22,0	1,740	1,920	1,875	1,505	1,625	-	22,0
24,0	1,525	1,710	1,700	1,325	1,445	-	24,0
26,0	1,345	1,520	1,525	1,135	1,270	1,230	26,0
28,0	1,210	1,360	1,365	1,000	1,135	1,115	28,0
30,0	1,065	1,210	1,245	0,855	0,995	0,995	30,0
32,0	0,945	1,080	1,080	0,740	0,875	0,880	32,0
34,0	0,830	0,965	0,980	0,625	0,755	0,760	34,0
36,0	0,740	0,850	0,895	0,530	0,640	0,675	36,0
38,0	0,645	0,770	0,780	-	0,565	0,575	38,0
40,0	0,570	0,675	0,675	-	-	0,505	40,0
42,0	-	0,590	0,615	-	-	-	42,0

80039886

Load charts • Traglasten • Capacités de levage • Capacidades Caracità • Diagramas de carga • Таблицы грузоподъемности

Swingaway • Klappspitze • Extension treillis • Plumín • Falcone • Jib • Складной удлинитель стрелы



11,0 - 33,5 m



10,1 - 29,2 m



100%



360°



6,5 t



85 %

m	10,1 m			17,1 m			m
	0°	25°	45°	0°	25°	45°	
9,0	5,860	-	-	-	-	-	9,0
10,0	5,860	-	-	3,775	-	-	10,0
12,0	5,860	4,920	-	3,775	-	-	12,0
14,0	5,825	4,700	3,360	3,775	-	-	14,0
16,0	5,260	4,355	3,215	3,760	2,400	-	16,0
18,0	4,665	3,935	3,100	3,480	2,345	-	18,0
20,0	4,100	3,565	3,005	3,225	2,310	1,750	20,0
22,0	3,710	3,250	2,920	2,990	2,250	1,690	22,0
24,0	3,345	2,980	2,800	2,690	2,090	1,620	24,0
26,0	3,015	2,740	2,610	2,425	2,020	1,560	26,0
28,0	2,705	2,540	2,435	2,195	1,920	1,525	28,0
30,0	2,410	2,355	2,280	2,000	1,770	1,480	30,0
32,0	2,110	2,155	2,105	1,830	1,640	1,460	32,0
34,0	1,770	1,955	-	1,675	1,520	1,425	34,0
36,0	1,470	1,630	-	1,540	1,410	1,350	36,0
38,0	1,205	1,340	-	1,400	1,315	1,270	38,0
40,0	0,970	-	-	1,215	1,220	-	40,0
42,0	-	-	-	1,000	1,140	-	42,0
44,0	-	-	-	0,800	0,945	-	44,0

80039618

m	23,1 m			29,2 m			m
	0°	25°	45°	0°	25°	45°	
14,0	2,925	-	-	-	-	-	14,0
16,0	2,565	2,655	-	1,975	-	-	16,0
18,0	2,245	2,435	2,345	1,795	-	-	18,0
20,0	1,960	2,180	2,095	1,665	-	-	20,0
22,0	1,740	1,920	1,875	1,505	1,625	-	22,0
24,0	1,525	1,710	1,700	1,325	1,445	-	24,0
26,0	1,345	1,520	1,525	1,135	1,270	1,230	26,0
28,0	1,210	1,360	1,365	1,000	1,135	1,115	28,0
30,0	1,065	1,210	1,245	0,855	0,995	0,995	30,0
32,0	0,945	1,080	1,080	0,740	0,875	0,880	32,0
34,0	0,830	0,965	0,980	0,625	0,755	0,760	34,0
36,0	0,740	0,850	0,895	0,530	0,640	0,675	36,0
38,0	0,645	0,770	0,780	-	0,565	0,575	38,0
40,0	0,570	0,675	0,675	-	-	0,505	40,0
42,0	-	0,590	0,615	-	-	-	42,0
44,0	-	0,515	-	-	-	-	44,0

80039622

Load charts • Traglasten • Capacités de levage • Capacidades Capacità • Diagramas de carga • Таблицы грузоподъемности

Swingaway • Klappspitze • Extension treillis • Plumín • Falcone • Jib • Складной удлинитель стрелы



11,0 - 33,5 m



10,1 - 29,2 m



50%



360°



6,5 t



DIN/ISO

m	10,1 m			17,1 m			m
	0°	25°	45°	0°	25°	45°	
9,0	5,860	-	-	-	-	-	9,0
10,0	5,860	-	-	3,085	-	-	10,0
12,0	5,860	4,840	-	3,005	-	-	12,0
14,0	5,715	4,650	3,360	2,925	-	-	14,0
16,0	4,630	4,355	3,215	2,850	2,400	-	16,0
18,0	3,780	3,935	3,100	2,775	2,340	-	18,0
20,0	3,095	3,565	3,005	2,700	2,270	1,750	20,0
22,0	2,530	2,940	2,920	2,625	2,205	1,690	22,0
24,0	2,060	2,415	2,625	2,165	2,090	1,620	24,0
26,0	1,655	1,965	2,135	1,770	2,020	1,560	26,0
28,0	1,280	1,550	1,690	1,435	1,920	1,525	28,0
30,0	0,960	1,190	1,305	1,114	1,595	1,480	30,0
32,0	0,685	0,885	0,965	0,875	1,265	1,460	32,0
34,0	-	0,615	-	0,635	0,970	1,175	34,0
36,0	-	-	-	-	0,710	0,880	36,0
38,0	-	-	-	-	-	0,620	38,0

80039883

m	23,1 m			m
	0°	25°	45°	
14,0	2,290	-	-	14,0
16,0	2,290	-	-	16,0
18,0	2,290	-	-	18,0
20,0	2,290	2,170	-	20,0
22,0	2,180	1,935	1,705	22,0
24,0	1,935	1,775	1,600	24,0
26,0	1,700	1,610	1,470	26,0
28,0	1,365	1,460	1,310	28,0
30,0	1,080	1,330	1,190	30,0
32,0	0,825	1,215	1,115	32,0
34,0	0,600	0,990	1,040	34,0
36,0	-	0,750	0,945	36,0
38,0	-	0,535	0,695	38,0

80039885

Load charts • Traglasten • Capacités de levage • Capacidades Caracità • Diagramas de carga • Таблицы грузоподъемности

Swingaway • Klappspitze • Extension treillis • Plumín • Falcone • Jib • Складной удлинитель стрелы



11,0 - 33,5 m



10,1 - 29,2 m



50%



360°



6,5 t



85 %

m	10,1 m			17,1 m			m
	0°	25°	45°	0°	25°	45°	
9,0	5,860	-	-	-	-	-	9,0
10,0	5,860	-	-	3,775	-	-	10,0
12,0	5,860	4,920	-	3,775	-	-	12,0
14,0	5,855	4,700	3,360	3,775	-	-	14,0
16,0	5,120	4,355	3,215	3,760	2,400	-	16,0
18,0	4,115	3,935	3,100	3,480	2,345	-	18,0
20,0	3,285	3,565	3,005	3,225	2,310	1,750	20,0
22,0	2,630	3,050	2,920	2,840	2,250	1,690	22,0
24,0	2,095	2,460	2,660	2,300	2,090	1,620	24,0
26,0	1,655	1,965	2,135	1,850	2,020	1,560	26,0
28,0	1,280	1,550	1,690	1,470	1,920	1,525	28,0
30,0	0,960	1,190	1,305	1,150	1,605	1,480	30,0
32,0	0,685	0,885	0,965	0,875	1,265	1,460	32,0
34,0	-	0,615	-	0,635	0,970	1,175	34,0
36,0	-	-	-	-	0,710	0,880	36,0
38,0	-	-	-	-	-	0,620	38,0

80039619

m	23,1 m			m
	0°	25°	45°	
14,0	2,830	-	-	14,0
16,0	2,715	-	-	16,0
18,0	2,710	-	-	18,0
20,0	2,470	2,170	-	20,0
22,0	2,180	1,935	1,705	22,0
24,0	1,935	1,775	1,600	24,0
26,0	1,725	1,610	1,470	26,0
28,0	1,480	1,460	1,310	28,0
30,0	1,155	1,330	1,190	30,0
32,0	0,875	1,215	1,115	32,0
34,0	0,630	1,025	1,040	34,0
36,0	-	0,770	0,955	36,0
38,0	-	0,545	0,705	38,0

80039621

Load charts • Traglasten • Capacités de levage • Capacidades de carga • Diagramas de carga • Таблицы грузоподъемности

Notes • Hinweise • Notes • Notas • Note • Notas • Примечания

The lifting capacities correspond to DIN EN 13000:2014-11 and 85 %.

Warning: THIS CHART IS ONLY A GUIDE. The Notes below are for illustration only and should not be relied upon to operate the crane. The individual crane's load chart, operating instructions and other instruction plates must be read and understood prior to operating the crane.

The lifting capacities likewise fulfil the requirements of ISO 4305 and DIN 15019, Part 2, with regard to stability, and DIN 15018, Part 3, and FEM 5004 with regard to strength.

85%: Capacities are in accordance with SAE J1063 and do not exceed 85% of the tipping load (SAE J1289 for outriggers 50% and 0% extended) as determined by SAE J765.

1. Capacities given do not include the weight of hookblocks, slings, auxiliary lifting equipment and load handling devices. Their weights MUST be added to the load to be lifted. When more than minimum required reeving is used, the additional rope weight shall be considered part of the load.
2. All capacities are for crane on firm, level surface. It may be necessary to have structural supports under the outrigger floats or tyres to spread the load to a larger bearing surface.
3. When either boom length or radius or both are between values listed, the smallest load shown at either the next larger radius or boom length shall be used.
4. For outrigger operation, ALL outriggers shall be fully extended with tyres raised free of ground before raising the boom or lifting loads.
5. Tyres shall be inflated to the recommended pressure before lifting on rubber.

Die Tragfähigkeiten entsprechen DIN EN 13000:2014-11 und 85 %.

WARNUNG: DIESE TABELLE IST LEDIGLICHE EINE RICHTLINIE. Die Hinweise dienen als Erklärung und sind für die Kranbedienung nicht maßgebend. Vor Inbetriebnahme des Kranes sind Traglasttabellen, Bedienungsanleitung und andere Vorschriften eingehend zu studieren.

Die Tragfähigkeitswerte erfüllen ebenfalls die Anforderungen von ISO 4305 und DIN 15019 Teil 2 bezüglich Standsicherheit sowie von DIN 15018 Teil 3 und FEM 5004 bezüglich Festigkeit.

85%: Tragkraftwerte entsprechen SAE J1063 und überschreiten nicht 85 % der Kipplast (SAE J1289 bei halb- bzw. ganz ausgefahrener Abstützung) gemäß Richtlinien SAE J765.

1. Das Gewicht der Hakenflaschen und aller Anschlagmittel muß zu der Last hinzugerechnet werden. Beim Einschleusen mit erhöhten Werten ist das zusätzliche Seilgewicht als Teil der Last zu betrachten.
2. Alle Werte gelten für den Kran auf festem, ebenem Untergrund. Eventuell müssen die Stützsteller oder Reifen unterlegt werden, um die Last über eine größere Abstützfläche zu verteilen.
3. Wenn Auslegerlänge oder Radius oder beide Werte zwischen den aufgeführten Werten liegen, ist die geringere der Traglasten zu wählen, die für den die nächstgrößere Ausladung oder die nächste bzw. anschließende Auslegerlänge genannt sind.
4. In abgestützem Zustand müssen ALLE Stützen komplette ausgefahren sein. Die Reifen dürfen den Boden nicht berühren. Erst danach dürfen Lasten oder der Ausleger angehoben werden.
5. Bevor frei auf Rädern gearbeitet wird, müssen, die Reifen mit dem vorschrittsmäßigen Druck aufgefüllt werden.

Les capacités de levage sont conformes à la norme DIN EN 13000:2014-11 et 85 %.

ATTENTION: CE TABLEAU N'EST QU'UN GUIDE. Les notes ci-dessous sont données à titre d'exemple et ne doivent pas être utilisées pour faire fonctionner la grue. Toute la documentation concernant chaque type de grue: tableau des charges, instructions de fonctionnement et toutes autres plaques d'instructions devront être lues et comprises avant de manoeuvrer la grue.

Les capacités de levage respectent également les exigences des normes ISO 4305 et DIN 15019, paragraphe 2, relatives à la stabilité, ainsi que celles des normes DIN 15018 paragraphe 3 et FEM 5004 relatives à la résistance.

85% : Les capacités de levage sont conformes à la norme SAE J1063 et ne dépassent pas 85% de la charge de basculement (SAE J1289 pour les poutres de calage déployées à 50% et 0%) tel que cela est prescrit par la norme SAE J765.

1. Les charges mentionnées dans les tableaux ne comprennent pas le poids des moufles, des élingues et autres accessoires de levage qui doit être additionné à celui de la charge levée. Lorsque le mouflage est supérieur au minimum requis le poids de l'excédent de câble doit être additionné à celui de la charge.
2. Les capacités sont données sur sol ferme et de niveau. Il peut être nécessaire d'utiliser des bastingas ou des accessoires similaires afin de répartir la charge transmise au sol par les roues ou les patins de calage.
3. Lorsque la longueur de flèche ou la portée ne correspond pas aux valeurs mentionnées dans les tableaux, il convient de se référer à la valeur inférieure mentionnée pour la portée ou la longueur de flèche immédiatement supérieure.
4. Pour utilisation machine calée, les poutres de calage doivent être totalement télescopées et les roues décollées du sol avant de relever la flèche ou de lever des charges.
5. Les pneumatiques devront être gonflés aux pressions préconisées avant tout levage en libre.

Las capacidades de carga corresponden a DIN EN 13000:2014-11 y 85 %.

AVISO: ESTA TABLA ES SOLO UNA ORIENTACION. Las notas que aparecen al final de la misma solo sirven de ilustración y no deben ser tomadas como instrucciones para operar la grúa. La tabla de cargas, las instrucciones de operación y otras placas ilustrativas de cada grúa deben ser leídas y correctamente interpretadas antes de operar la grúa.

Asimismo los valores de carga cumplen las disposiciones de las normas ISO 4305 y DIN 15019, 2.ª parte, respecto a la estabilidad, y DIN 15018, 3.ª parte, y FEM 5004 respecto a la fuerza.

85%: Le capacità di sollevamento sono conformi alla norma SAE J1063 e non superano l'85% del carico di ribaltamento (SAE J1289 per gli stabilizzatori estesi al 50% e 0%) come prescritto dalla norma SAE J765.

1. Las cargas indicadas no incluyen el peso de los ganchos, eslingas, equipos auxiliares y aparejos de elevación. Sus pesos DEBEN ser añadidos al de la carga a elevar. Cuando se utilice un número de ramales de cable superior al necesario, el peso adicional del cable debe ser considerado como parte de la carga.
2. Todas las capacidades corresponden a la grúa situada sobre terreno firme nivelado y uniforme. La naturaleza del terreno puede hacer necesario colocar, bajo los apoyos de los estabilizadores o bajo los neumáticos, elementos estructurales que repartan la carga sobre una mayor superficie de apoyo.
3. Cuando se trabaje con longitudes de pluma o radios, intermedios entre los valores reflejados en las tablas, se considerará la carga inmediata inferior indicada en el radio o longitud de pluma inmediato superior.
4. Para trabajos sobre estabilizadores, TODOS los estabilizadores estarán totalmente extendidos y los neumáticos sin tocar el suelo antes de elevar pluma o izar cargas.
5. Los neumáticos deberán estar inflados a la presión recomendada antes de elevar cargas sobre neumáticos.

Le tabelle di portata sono conformi alle norme DIN EN 13000:2014-11 e 85 %.

ATTENZIONE: QUESTA TABELLA E' SOLO UNA GUIDA. Le note qui sotto riportate sono date a titolo d'esempio e non devono essere utilizzate per far funzionare la gru.

La tabella di carico, le istruzioni d'uso ed ogni altro foglio illustrativo devono essere letti e compresi prima di manovrare la gru.

I valori delle tabelle di portata sono conformi anche ai requisiti delle norme ISO 4305 e DIN 15019, Parte 2, per quanto riguarda la stabilità, ed alle norme DIN 15018, Parte 3, e FEM 5004 per quanto riguarda il calcolo di resistenza della struttura.

85%: Capacidades de acuerdo con las Normas SAE J1063 y no exceden del 85% del momento de vuelco (Normas SAE J1289 para las cargas sobre estabilizadores extendidos al 50% o sin extender 0%) como fijan las normas SAE J765.

1. I carichi indicati nelle tavole non comprendono il peso dei ganci, dei tiranti, e di nessun altro accessorio di sollevamento che deve essere aggiunto a quello del carico sollevato. Quando il numero di funi è superiore al minimo richiesto il peso addizionale della fune deve essere aggiunto a quello del carico.
2. Tutte le capacità si intendono per la gru situata su un terreno compatto livellato e uniforme. Potrebbe rendersi necessario utilizzare dei supporti strutturali, sotto gli appoggi degli stabilizzatori o sotto i pneumatici, per ripartire il carico su una superficie di appoggio maggiore.
3. Quando la lunghezza del braccio o la portata non corrispondono ai valori riportati nelle tabelle, conviene considerare il valore inferiore riportato nel raggio di lavoro o la lunghezza del braccio immediatamente superiore.
4. Per lavoro su stabilizzatori, TUTTI gli stabilizzatori devono essere completamente estesi e i pneumatici staccati da terra prima di rialzare il braccio o di sollevare carichi.
5. I pneumatici devono essere gonfiati alla pressione raccomandata prima di sollevare carichi sopra i pneumatici.

Capacidade de carga corresponde a DIN EN 13000:2014-11 e 85 %.

Atenção: ESTE QUADRO SERVE APENAS DE GUIA. As notas abaixo são dadas a mero título exemplificativo e não deverão ser utilizadas para operar a grua. Toda a documentação e instruções relativas a cada tipo de grua, nas quais se incluem o diagrama de carga da grua, as respectivas instruções de operação e outras placas com instruções, têm de ser lidas e compreendidas antes de a grua ser operada.

Capacidade de elevação também satisfazer os requisitos da norma ISO 4305 e DIN 15019, Parte 2, a estabilidade relativa, bem como os da DIN 15018 3 e GEF 5004 no que diz respeito à sua resistência.

85%: Le capacità di sollevamento sono conformi alla norma SAE J1063 e non superano l'85% del carico di ribaltamento (SAE J1289 per gli stabilizzatori estesi al 50% e 0%) come prescritto dalla norma SAE J765.

1. As capacidades indicadas não incluem o peso de cadernas, eslingas, equipamento auxiliar de elevação e dispositivos de manuseamento de cargas. Os seus pesos TEM de ser adicionados ao peso da carga a ser elevada. Sempre que for utilizada mais de que uma desmultiplicação de cabo, o peso adicional dos cabos deverá ser considerado parte da carga, devendo ser adicionado ao seu peso.
2. Todas as capacidades são indicadas para uma grua sobre uma superfície firme e nivelada. Pode ser necessário colocar suportes estruturais por baixo dos pneus ou das sapatas dos estabilizadores, para espalhar a carga por uma superfície de suporte maior.
3. Sempre que o comprimento da lança, o seu raio, ou ambos estiverem compreendidos entre os valores indicados, deve ser utilizada a carga mais baixa indicada para o raio ou para o comprimento de lança imediatamente superior.
4. Operação com estabilizadores: Antes de a lança ser erguida ou de serem elevadas cargas, TODOS os estabilizadores têm de estar totalmente estendidos, com os pneus erguidos de modo a não estarem em contacto com o solo.
5. Antes de serem elevadas cargas sobre os pneus, eles devem ser enchidos às pressões recomendadas.

Грузоподъемность соответствует стандарту DIN EN 13000:2014-11 и 85 %.

Внимание: ДАННАЯ СХЕМА ПРИВЕДЕНА ИСКЛЮЧИТЕЛЬНО В ОЗНАКОМИТЕЛЬНЫХ ЦЕЛЯХ. Нижеприведенные данные являются лишь пояснительными, на них не следует полагаться при работе с краном. Перед работой на кране следует прочесть и понять таблицы грузоподъемности, инструкцию по эксплуатации, а также инструктирующие таблички.

Кроме того, грузоподъемность удовлетворяет требованиям ISO 4305 и DIN 15019 (часть 2) в отношении устойчивости, и DIN 15018, (часть 3), и FEM 5004 в отношении прочности материала.

85%: Нагрузка соответствует стандарту SAE J1063 и не превышает 85% от удерживающего момента (SAE J1289 для выносных опор, выдвигаемых на 50% и на 0%) в соответствии с SAE J765.

1. Указанная нагрузка не учитывает вес крюковых блоков, канатов, вспомогательного подъемного оборудования и грузочной/разгрузочной устройств. Их вес СЛЕДУЕТ прибавлять к массе груза. При превышении минимально необходимой запасовки канатаследует учитывать его дополнительный вес.
2. Все нагрузки указаны для крана, находящегося на прочной плоской поверхности. С целью распределения нагрузки, под выносные опоры или под колеса можно подложить поддерживающие конструкции для увеличения площади опоры.
3. Если длина стрелы, вылет (или и то и другое) находятся между указанными значениями в таблице, следует брать наименьшую нагрузку, указанную за следующим значением радиуса или длины стрелы.
4. Перед подъемом стрелы или грузов (при использовании выносных опор) следует выдвинуть ВСЕ выносные опоры на полную длину, чтобы колеса оказались над землей.
5. При подъеме с колес, шины должны быть накачаны до рекомендуемого давления.

Superstructure



Boom

11 m – 33,5 m, four-section, full-power sequenced synchronized boom. Maximum tip height: 36,4 m.



*Fixed swingaway extension

10,1 m offsettable lattice swingaway extension. Offsets 0°, 25° and 45°. Stows alongside base boom section. Maximum tip height: 45,8 m.



*Bifold swingaway extension

10,1 m - 17,1 m bifold lattice swingaway extension. Offsettable at 0°, 25° and 45°. Stows alongside base boom section. Maximum tip height: 52,8 m.



*Inserts

6,1 m or 12,2 m lattice extension inserts. Installs between the boom nose and bifold extension, non-stowable. Maximum tip height: 65,2 m.



Boom elevation

One double acting hydraulic cylinder with integral holding valve provides elevation from -3° to +78°.



Load moment and anti-two block system

Standard "Graphic Display" load moment and anti-two block system with audio-visual warning and control lever lockout. These systems provide electronic display of boom angle, length, radius, tip height, relative load moment, maximum permissible load, load indication and warning of impending two-block condition. The standard Work Area Definition System allows the operator to pre-select and define safe working areas. If the crane approaches the pre-set limits, audio-visual warnings aid the operator in avoiding job-site obstructions.



Cab

Full-vision, all-steel fabricated with acoustical lining and tinted safety glass throughout. Deluxe seat incorporates armrest-mounted hydraulic single-axis controllers. Dash panel incorporates gauges for all engine functions. Other standard features include: hot water heater, cab circulating air fan, sliding side and rear windows, sliding skylight with electric wiper and sunscreen, electric windshield wash/wipe, fire extinguisher and seat belt, air conditioning.



Slewing

Planetary swing drive with foot applied multi-disc brake. Spring applied, hydraulically released swing brake and plunger-type, one position mechanical house lock, operated from cab. Maximum speed: 2,5 RPM.



Counterweight

6 516 kg pinned to structure.



Hydraulic system

Three main pumps with a combined capacity of 391 LPM (511 LPM with optional air conditioning).

Maximum operating pressure: 276 bar.

Two individual post pressure compensated valve banks.

Return line type filter with full flow by-pass protection and service indicator.

Replaceable cartridge with micron filtration rating of 5/12/16.

500 L hyd. reservoir. Integral oil cooler. System pressure test ports.



Hoist

Planetary reduction with automatic spring applied multi-disc wet brake. Grooved drum. Electronic hoist drum rotation indicators, and hoist drum cable followers.

Maximum Single Line Pull: 8 246 kg.

Maximum Permissible Line Pull:

7 620 kg with standard 6X37 class rope.

7 620 kg. with optional 35X7 class rope.

Maximum Single Line Speed: 156 m/min.

Rope Construction: 6X37 EIPS IWRC,

35x7 Flex-X, Rotation Resistant

Rope Diameter: 19mm. Rope Length: Main Hoist: 152 m - Optional: 168 m.

Maximum Rope Stowage: 256 m.



CraneSTAR

Crane asset management system.

Carrier



Carrier frame

Box section frame fabricated from high-strength, low alloy steel.

Integral outrigger housings and front/rear towing, lifting and tie down lugs.



Outriggers

Four hydraulic telescoping single-stage double box beam outriggers with inverted jacks and integral holding valves. Three position setting, 0%, 50% and fully extended. All steel fabricated, quick release type outrigger floats, 610 mm diameter. Maximum outrigger pad load: 36 606 kg. Controls and crane level indicator located in cab.



Engine

Tier 3 / Euromot 3A: Cummins QSB 6.7 l diesel, six cylinders, turbocharged, 179 kW at 2500 rpm. Maximum torque: 987 Nm at 1500 rpm.

Note: Required for sale outside of North American and European Union countries

Tier 4f / Euromot 4: Cummins QSB 6.7 l diesel, six cylinders, turbocharged with Cummins Diesel Particulate Exhaust filter/muffler. Meets emissions per U.S.E.P.A.

Tier IV and E.U. Stage III B. 179 kW at 2500 rpm. Maximum torque: 990 Nm at 1500 rpm. Fuel requirement: Maximum of 15 ppm sulphur content (Ultra Low Diesel Fuel). Note: Tier IV engine Required in North American and European Union countries.

Fuel tank capacity: 280 l.



Transmission

Spicer powershift with 6 forward and 6 reverse speeds.

Front axle disconnect for 4 x 2 travel.



Drive/Steer

4 x 4. Fully independent power steering:

Front: Full hydraulic steering wheel controlled.

Rear: Full hydraulic switch controlled.

Provides infinite variations of 4 main steering modes: front only, rear only, crab and coordinated. Rear steer indicator. Turning radius: 6,7 m.



Axles

Front: Drive/steer with differential and planetary reduction hubs rigid mounted to frame.

Rear: Drive/steer with differential and planetary reduction hubs pivot mounted to frame.



Tyres

Std. 29,5 x 25 - 28 bias ply.



Lights

Full lighting including turn indicators, head, tail, brake and hazard warning lights.



Maximum Speed

37 km/h.



Gradeability (theoretical)

130% (Based on 42 388 kg GVW) 29.5 x 25 tires, pumps engaged, 33,6 m boom, bi-fold extension, aux. hoist and cable, and 55 t hookblock.



Brakes

Full hydraulic split circuit operating on all wheels. Spring-applied, hydraulically released parking brake.



Electrical system

Two 12 V - maintenance free batteries. 12 V starting and lighting.

Battery disconnect switch.

* Optional equipment

- Auxiliary Hoist Package (includes model HP30A-19G auxiliary hoist with electronic hoist drum rotation indicator, hoist drum cable follower, 152 m of 19 mm 35 x 7 class wire rope, auxiliary single sheave boom nose.
- Auxiliary Light and Convenience Package: includes superstructure mounted amber flashing light, in-cab LMI light bar, and dual base boom mounted floodlights, rubber mat for stowage trough
- CE Mark Conformance
- Cross axle differential locks (front and rear)
- Manual pump disconnect
- Pintle hook - rear
- 360° NYC style positive swinglock
- Hydraulic removable counterweight
- 3rd wrap indicator with function lockout for main hoist or main and auxiliary hoist
- Wireless windspeed indicator

*Further optional equipment upon request.

Kranoberwagen

Ausleger

Von 11 m bis 33,5 m ausfahrbarer, vierteiliger, voll teleskopierbarer Ausleger mit Synchronverstellung. Maximale Rollenhöhe 36,4 m.

*Feststehender Klappspitzenausleger

Abwinkelbare Klappspitze in Gitterbauweise, 10,1 m Länge. Abwinkelung 0°, 25° und 45°. Seitlich am Ausleger montierbar. Maximale Arbeitshöhe : 45,8 m.

*Doppelklappspitze

Abwinkelbare Doppel-Klappspitze in Gitterbauweise, 10,1 - 17,1 m. Abwinkelbar 0°, 25°, 45°, an den Teleskop-Grundausleger anklappbar. Maximale Arbeitshöhe : 52,8 m.

*Teleskopklappspitze

Zwischenstücke in Gitterbauweise mit einer Länge von 6,1 m oder 12,2 m. Anbau zwischen Auslegerkopf und Doppel-Klappspitze, nicht am Kran verstaubar. Maximale Rollenhöhe: 65,2 m.

Wippwerk

Ein doppelt wirkender Hydraulikzylinder mit integriertem Sicherheits-Rückschlagventil. Auslegerstellwinkel von -3° bis +78°.

Lastmoment- und Hubendschalter-System

System für Lastmomentbegrenzung über Standard-„Grafikdisplay“ und Anti-Two Block System mit akustisch-optischer Warnung und Steuerhebelsperre. Diese Systeme bieten elektronische Anzeige von Auslegerwinkel, Auslegerlänge, Radius, Arbeitshöhe, relativem Lastmoment, maximal zulässiger Last, Hakenlast und Hubendschaltungs-Vorrichtung. Das zur Standardausrüstung gehörende System zur Arbeitsbereichsbegrenzung ermöglicht es dem Bediener, sichere Arbeitsbereiche vorzugeben und zu definieren. Nähert sich der Kran der Begrenzung des sicheren Arbeitsbereichs, wird der Bediener akustisch und optisch gewarnt, wodurch Kollisionen am Einsatzort vermieden werden.

Kabine

Rundsichtkabine, in Stahlblech ausgeführt, mit Schalldämmung und getöntem Sicherheitsglas. Komfortsitz mit in die Armlehnen integrierten, einachsigen verstellbaren Steuerhebeln. Armaturenbrett mit Anzeigen für alle Motorfunktionen. Weitere Standardausrüstung: Heißwasserheizung, Umluftgebläse, Schiebefenster seitlich und hinten, Dachschiebefenster mit elektrischem Scheibenwischer und Sonnenschutz, elektrischer Frontscheibenwischer/Waschanlage, Feuerlöscher und Sicherheitsgurt, Klimaanlage.

Schwenkwerk

Drehwerk mit Planetengetriebe mit per Fuß zu bedienender Mehrscheibenbremse. Federgetriebene, hydraulisch zu lösende Drehwerksbremse und Stoßelform, Gehäusefixierung, bedienbar von Kabine aus. Max. Drehgeschwindigkeit: 2,5 RPM.

Gegengewicht

6 516 kg, mit dem Oberwagen verbolzt.

Hydrauliksystem

Drei Hauptpumpen mit einer Gesamtfördermenge von 391 l/Min (511 l/Min, wahlweise mit Klimaanlage). Maximaler Betriebsdruck: 276 bar. Zwei einzelne druckkompensierte Ventilblöcke. Filter mit Vollstrom-Bypassschutz und Wartungsanzeige im Rücklauf. Wechselpatrone mit einer Filtrierleistung von 5/12/16 Mikron. Fassungsvermögen des Hydrauliköltanks: 500 Liter. Integrierter Ölkühler. Systemdruck-Prüfanschlüsse.

Hubwerk

Planetengetriebe mit automatischer Federspeicher-Mehrscheibenbremse im Ölbad. Gerillte Seiltrommel. Elektronischer Hubwerksumdrehungs-Melder sowie Seilführungsbügel.

Maximaler Seilzug mit einfachem Strang:

- Erste Lage : 8 246 kg

Maximal zulässiger Seilzug:

- 7 620 kg mit Seil Kategorie 6 x 37

- 7 620 kg mit Seil Kategorie 35x7

Maximale Seilgeschwindigkeit mit einfachem Strang: 156 m/Min.

Seilaufbau : 6X36 EIPS IWRC. 35x7 Flex-X, drallfrei.

Seildurchmesser : 19 mm. Seillänge: Haupthubwerk : 152 m. Hilfshubwerk : 168 m.

Hubwinde für max. 256 m Seil ausgelegt.

CraneSTAR

Krananlagegüterverwaltungssystem

Kranunterwagen

Rahmen

Kastenprofilrahmen aus hochfestem Feinkornstahl. Integrierte Auslegerbalkengehäuse und vordere/hintere Greifer zum Schleppen, Heben und Verzurren.

Abstützung

Vier hydraulisch teleskopierbare, einteilige Kastenprofil-Abstützträger mit innen geführten Stützzyllindern und integrierten Halteventilen. Drei Stellungen: 0%, 50% und voll ausgefahren. Abstützteller mit Schnellverriegelung aus Stahl, Durchmesser 610 mm, maximaler Stützdruck per Teller 36 606 kg. Bedienelemente und Nivellieranzeige in der Kabine.

Motor

Tier 3 / Euromot 3A: Cummins QSB 6,7 L Dieselmotor, sechs Zylinder, Turbolader, 179 kW bei 2500 U/min. Maximales Drehmoment: 987 Nm bei 1500 U/min. Hinweis: Zum Verkauf außerhalb Europas und Nordamerikas bestimmt.

Tier 4f / Euromot 4: Cummins QSB 6,7 L Dieselmotor, sechs Zylinder, mit Turbolader und Cummins-Dieselfpartikelfilter/-dämpfer. Entspricht Emissionsvorgaben nach U.S.E.P.A. Tier IV und E.U. Stage III B. 179 kW bei 2500 U/min. Maximales Drehmoment: 990 Nm bei 1500 U/min. Treibstoffart: Maximal 15 ppm Schwefelanteil (besonders schwefelarmer Dieselmotortreibstoff). Hinweis: Diese Motoren sind zum Verkauf in Nordamerika und der Europäischen Union bestimmt.

Kraftstoffbehälter: 280 l

Getriebe

Spicer Powershiftautomatikgetriebe, 6 Vorwärtsgänge und 6 Rückwärtsgänge. Abkoppelung der Vorderachse für Fahrtrieb 4 x 2.

Antrieb/Lenkung

4 x 4. Separate Servolenkung :

Vorne : Vollhydraulisch, über Lenkrad betätigt.

Hinten : Vollhydraulisch, über Schalter betätigt.

Stellt vier stufenlos veränderliche Lenkarten bereit : Nur vorne, nur hinten, Hundegang und koordiniert. Lenkungsanzeige hinten. Wendekreis : 6,7 m.

Achslinien

Vorne: Antrieb/Lenkung über Differenzial und Planetenuntersetzungsgetriebe, fest mit dem Rahmen verbunden.

Hinten: Antrieb/Lenkung über Differenzial und Planetenuntersetzungsgetriebe, pendelnd mit dem Rahmen verbunden.

Bereifung

29,5 x 25 – 28-lagig, Diagonalreifen.

Beleuchtung

Volle Beleuchtungsanlage mit Blinkleuchten, Scheinwerfern, Schluss- und Bremsleuchten und Warnblinkanlage.

Höchstgeschwindigkeit

37 km/h.

Steigvermögen (theoretisch)

130 % (basierend auf: Bruttogewicht des Fahrzeugs 42.388 kg, Reifengröße 29,5 x 25, Pumpen aktiviert, Ausleger 33,6 m, Doppelklappspitze, Hilfshubwerk mit Seil und Hakenflasche 55 t).

Bremsen

Vollhydraulische Bremsen mit geteilten Bremskreisen, auf alle Räder wirkend. Hydraulisch lösbare Federspeicher-Feststellbremse, auf die Vorderachse wirkend.

Elektrische Anlage

Zwei wartungsfreie 12-Volt-Batterien. 12-Volt-Starter und Beleuchtungsanlage. Batterie-Trennschalter.

* Zusatzausrüstung

- Zusätzliche Gewindeausrüstung: inkl. HP30-A-19G Hilfswinde mit elektronischer Gewindetrommelrotationsanzeige, Windtrommelnachlaufregler, 152 m langem Drahtseil (19 mm) Klasse 35 x 7, Hilfsauslegerkopf mit Einzel-Seilscheibe
- Zusatzausrüstung für Beleuchtung: inkl. an Oberbau befestigte Blinkleuchte (Farbe: orange) kabineninterne LMI-Lichtbalken und zwei am Ausleger-Grundstück montierte Flutlichter, Gummimatte für Stauraum
- CE-zertifiziert
- Querdifferentialsperren (vorne und hinten)
- Handpumpe Trennung
- Fanghaken - hinten
- Schwenkwerksverriegelung, 360 Grad, Typ NYC
- Hydraulisch entfernbares Gegengewicht
- Windenseil 3-Lagen-Anzeige mit Funktions-Lockout für Hauptwinde oder für Haupt- und Hilfswinde
- Drahtlose Windgeschwindigkeitsanzeige

*Weitere Zusatzausrüstungen auf Anfrage.

Superstructure



Flèche

11 m - 33,5 m. Flèche télescopique hydraulique à quatre éléments, séquencée et synchronisée. Hauteur maximale de tête de flèche : 36,4 m.



*Extension treillis fixe

Extension treillis à repliage latéral de 10,1 m avec possibilité de déport à 0°, 25° et 45°. Repliage le long de l'élément de flèche de base. Hauteur max. de tête d'extension : 45,8 m.



*Extension treillis à double repliage

Extension treillis à double repliage latéral de 10,1 à 17,1 m avec possibilité de déport à 0°, 25° et 45°. Repliage le long de l'élément de flèche de base. Hauteur max. de tête d'extension : 52,8 m.



*Éléments intermédiaires pour extension de treillis

Éléments intermédiaires de 6,1 ou 12,2 m pour extension treillis installés entre la tête de flèche principale et l'extension treillis double (éléments transportés séparément). Hauteur maximum d'extension treillis : 65,2 m



Relevage

Un vérin hydraulique double effet avec clapet anti-retour intégré. Angles de relevage - 3° à + 78°.



Contrôleur d'état de charge et dispositif de fin de course haute crochet indépendant

En standard, contrôleur d'état de charge à affichage graphique et dispositif de course haute avec alarmes sonores et visuelles et dispositif de coupure des mouvements. Ces dispositifs donnent un affichage graphique de l'angle et de la longueur de flèche, de la portée, de la hauteur de tête de flèche, du moment relatif, de la charge maximum autorisée, de la charge levée et de sécurité de fin de course haute crochet. Le dispositif standard de limitation du domaine d'évolution (Work Area Definition System) permet à l'utilisateur de pré-définir et limiter le domaine de travail autorisé.



Cabine

Cabine panoramique tout acier avec isolation sonore et vitrages de sécurité teintés. Siège ergonomique équipé de manipulateurs multidirectionnels électriques doubles-axes intégrés aux accoudoirs. Tableau de bord équipé de tous les instruments nécessaires à la surveillance du moteur. Autres équipements montés en standard : colonne de direction réglable en inclinaison, chauffage de cabine à eau chaude, ventilateur, vitrages coulissants latéraux et arrière, vitre de toit coulissante équipée d'un essuie-glace et d'un rideau pare-soleil, essuie-glace et lave-glace de pare-brise, extincteur et ceinture de sécurité, air conditionné.



Orientation

Orientation à planétaires et frein multi-disques à commande au pied. Frein à serrage par ressorts et desserrage hydraulique, verrouillage mécanique sur une position, à poussoir, actionné depuis la cabine. Vitesse maximale : 2,5 tpm.



Contrepoids

6 516 kg broché à la structure.



Système hydraulique

Trois pompes principales offrant une capacité combinée de 391 l/min (511 l/min avec un dispositif d'air conditionné). Pression maximum de service : 276 bars. Deux distributeurs hydrauliques indépendants avec compensateurs de pression. Filtre hydraulique sur circuit de retour avec protection par dérivation plein débit et indicateur de colmatage. Cartouche amovible avec classe de filtration micrométrique 5/12/16. Réservoir hydraulique de 500 litres. Prises de pressions rapides.



Treuil

Entraînement par réducteur à planétaires et frein multi-disques immergés. Tambour rainuré. Indicateurs électroniques de rotation du treuil et dispositif presse-câble. Efforts max. sur brin simple : 8 246 kg
Effort max. autorisé sur brin simple : 7 620 kg avec câble standard 6x37
7 620 kg avec câble optionnel 35x7

Vitesse max. de déroulement : 156 m/min.

Câble type 6 x 37 EIPS IWRC ou 35x7 Flex-X, antigiratoires. Diamètre : 19 mm.

Longueur de câble : Treuil principal : 152 m. Treuil auxiliaire : 168 m

Capacité maximum de câble : 256 m



CraneSTAR

Système de gestion de parc de grues.

Châssis



Châssis

Châssis caissonné mécanosoudé en acier à haute limite élastique. Carters intégrés pour les dispositifs de calage et anneaux avant/arrière pour remorquage, levage et fixation.



Dispositif de calage

Quatre poutres de calage hydrauliques télescopiques avec vérins inversés et clapets anti-retour intégrés. Calage autorisé en trois positions : 0 - 50% et 100%. Patins d'appui carrés (610 mm de diamètre) en acier avec dispositifs de fixation rapide. Charge maximum sur appui : 36 606 kg. Commandes de calage et indicateur de niveau dans la cabine.



Moteur

Tier 3 / Euromot 3A: Cummins QSB 6,7 L diesel, six cylindres, à turbocompresseur, 179 kW à 2500 tr/min. Couple maximal : 987 Nm à 1500 tr/min. Note : Requis pour les ventes hors des pays d'Amérique du Nord et de l'Union européenne.

Tier 4f / Euromot 4: Cummins QSB 6,7 L diesel, six cylindres, à turbocompresseur, avec filtre/silencieux d'échappement à particules Cummins Diesel. Respecte les exigences en matière d'émissions selon l'U.S.E.P.A. Tier IV et U.E. Phase III B. 179 kW à 2500 tr/min. Couple maximal : 990 Nm à 1500 tr/min. Exigences relatives au carburant : Maximum de 15 ppm de teneur en soufre (carburant diesel à très faible teneur). Note : Moteur Tier IV requis dans les pays d'Amérique du Nord et de l'Union européenne.

Capacité du réservoir : env. 280 l.



Boîte de vitesses

Boîte de vitesses Spicer à 6 rapports avant et 6 rapports arrière. Débrayage de pont avant pour déplacement en 4 x 2.



Direction/Transmission

4 x 4. Direction hydraulique indépendante :

Avant : Direction hydraulique indépendante actionnée par volant.

Arrière : Direction hydraulique indépendante commandée par interrupteur au tableau de bord.

Combinaisons infinies des quatre modes de direction : avant uniquement, arrière uniquement, marche en crabe et mode coordonné. Indicateur de direction arrière. Rayon de braquage : 6,7 m.



Ponts

Avant : Pont moto-directeur avec différentiel et réductions à planétaires dans les moyeux fixé de manière rigide au châssis.

Arrière : Pont moto-directeur avec différentiel et réductions à planétaires dans les moyeux articulé au châssis



Pneumatiques

29,5 x 25 à carcasse conventionnelle 28 plis.



Eclairage

Eclairage complet incluant les clignotants, ainsi que les feux avant, arrière, de freinage et de détresse.



Vitesse maximum

37 km/h.



Aptitude (théorique) en pente

130 % pour un véhicule d'un poids total de 42 388 kg, équipé de pneus 29,5 x 25, pompes enclenchées, d'une flèche de 33,6 m, d'une extension treillis double, d'un treuil auxiliaire, de câbles et d'un moufle de 55 t.



Freins

Freinage sur toutes les roues avec circuit scindé. Frein de stationnement à serrage par ressorts et desserrage hydraulique sur l'essieu avant.



Installation électrique

Deux batteries sans entretien de 12 Volts pour l'éclairage et le démarrage.

Coupe circuit. Interrupteur coupe-circuit.

* Equipements optionnels

- Treuil auxiliaire (modèle HP30A-19G) avec indicateur électronique de rotation du tambour, dispositif presse-câble sur le tambour, 152 m de câble métallique de 19 mm de classe 35 x 7, une tête de flèche auxiliaire à réa simple.
- Ensemble d'éclairage auxiliaire et d'accessoires : gyrophare orange sur la superstructure, barrette d'affichage CEC en cabine, deux projecteurs installés sur la flèche de base, tapis de caoutchouc pour le coffre de stockage
- Conformité CE
- Différentiels inter-roues (avant et arrière)
- Débrayage manuel de pompe
- Crochet de remorquage arrière
- Verrouillage mécanique d'orientation 360° (type Ville de New York)
- Contrepoids à retrait hydraulique
- 3° indicateur de circuit avec verrouillage de fonction pour le treuil principal ou les treuils principal et auxiliaire
- Anémomètre sans fil

* Autres équipements optionnels sur demande.

Características técnicas

Superestructura



Pluma

11 m - 33,5 m. Pluma de cuatro secciones, sincronizada y totalmente hidráulica. Altura máxima en punta al suelo : 36,4 m.



*Plumín fijo abatible

Plumín de celosía de 10,1 m. Angularde 0°, 25° y 45°. Abatible en el lateral de la pluma. Altura máxima en punta al suelo: 45,8 m.



*Plumín articulado abatible

Plumín articulado de celosía plegable en dos secciones de 10,1 m - 17,1 m. Angularde 0°, 25° y 45°. Abatible en el lateral de la pluma. Altura máxima de la punta al suelo: 52,8 m.



*Extensión de pluma

Secciones de intermedias de 6,1 m o 12,2 m. Se colocan entre la cabeza de la pluma y el plumín articulado en dos secciones. No pueden abatirse en el lateral de la pluma. Altura máxima en punta al suelo: 65,2 m.



Elevación de pluma

Un cilindro hidráulico de doble efecto con válvula de retención integrada logrando elevación entre -3° y +78°.



Sistema indicador del momento de carga y de final de carrera del gancho

Momento de carga estándar "con indicador gráfico" y sistema antibloqueo doble con señal de aviso sonora y visual y bloqueo de la palanca de control. Estos sistemas proporcionan la visualización en una pantalla electrónica del ángulo, longitud, radio, altura de la punta al suelo, momento de carga relativo, carga máxima admisible, indicación de carga y aviso del estado del bloqueo doble inminente de la pluma. El sistema de definición del área de trabajo estándar permite al operario preseleccionar y definir zonas de trabajo seguras. Si la grúa se acerca a los límites predefinidos, una señal de aviso sonora y visual ayuda al operario a evitar obstrucciones en el lugar de la obra.



Cabina

Cabina de visión panorámica, toda ella fabricada en acero con revestimiento acústico y cristal de seguridad tintado por completo. Asiento de lujo que incorpora los controles eléctricos de operación montados en reposabrazos. El panel de instrumentos incorpora indicadores para todas las funciones del motor. Forman parte del equipo de serie: volante regulable en altura, calefacción de agua, ventilador para la cabina, ventanillas laterales y traseras deslizantes, ventana superior abatible con limpia-parabrisas eléctrico y parasol, extintor y cinturón de seguridad, aire acondicionado.



Rotación

Giro deslizante mediante planetarios con freno de discos múltiples accionado por pedal. Freno de giro de desconexión hidráulica, accionado mediante resorte. Bloqueo interno mecánico de una única posición accionado desde la cabina. Velocidad máxima: 2,5 rpm.



Contrapeso

Sujeto a la estructura mediante bulones. 6 516 kg. de peso.



Sistema hidráulico

Tres bombas principales con una capacidad combinada de 391 lmp (511 lmp con aire acondicionado opcional). Presión de funcionamiento máxima: 276 bares. Dos bancos de válvulas de presión compensada individuales. Filtro con línea de retorno con protección total ante derivaciones de flujo e indicador de mantenimiento. Cartucho reemplazable con una tasa de microfiltrado de 5/12/16. Depósito hidráulico de 500 L. Refrigerador de aceite integrado. Puertos de prueba de presión del sistema.



Mecanismo de elevación principal y auxiliar

Reducción planetaria con freno automático de discos múltiples aplicado mediante resorte. Tambor acanalado con indicadores electrónicos de rotación del tambor.

Tensión máxima de un solo ramal de cable: 8 246 kg

Tracción máxima admisible del cable: 7 620 kg con cable de clase 6x37.
7 620 kg con cable 35 x 7.

Velocidad máxima de un solo cable: 156 m/min

Cable : 6x36 EIPS IWRC, flexible especial o 35x7 Flex-X, antirotación.

Diámetro del cable : 19 mm. Longitud del cable : Cabrestante principal: 152 m.

Auxiliar: 168 m. Capacidad máxima de cable en el tambor : 256 m.



CraneSTAR

Sistema de gestión de flotas de grúas

Chasis



Bastidor

Estructura tipo cajón fabricada en acero de alta resistencia y baja aleación. Encajaduras de estabilizadores integradas y orejetas de elevación y amarre y tracción delantera/trasera.



Estabilizadores

Cuatro estabilizadores hidráulicos telescópicos de doble viga con gatos invertidos y válvulas de retención integradas. Tres ajustes de posición: 0%, 50% y totalmente extendidos. Base de los estabilizadores de montaje rápido, fabricadas completamente en acero de 610 mm. de diámetro. Carga máxima sobre cada placa de apoyo: 36 606 kg. Controles e indicador del nivel de la grúa situados en la cabina.



Motor

Tier 3 / Euromot 3A: Cummins QSB 6,7 L diésel, seis cilindros, turboalimentado, 179 kW a 2500 rpm. Par máximo: 987 Nm a 1500 rpm. Nota: Requerido en ventas fuera de los países norteamericanos y de la Unión Europea.

Tier 4f / Euromot 4: Cummins QSB 6,7 L diésel, seis cilindros, turboalimentado con silenciador/filtro de partículas diesel Cummins. Cumple los estándares de emisiones Tier IV de la U.S.E.P.A. y Fase IIIB de la U.E. 179 kW a 2500 rpm. Par máximo: 990 Nm a 1500 rpm. Exigencias de combustible: máximo de 15 ppm de contenido de azufre (diesel de muy bajo contenido en azufre). Nota: motor Tier IV requerido en los países norteamericanos y de la Unión Europea.

Capacidad del depósito de combustible: 280 litros



Transmisión

Spicer powershift con 6 marchas de avance y otras 6 de marcha atrás. Desconexión del eje frontal para un desplazamiento 4 x 2.



Tracción/Dirección

4 x 4.

Dirección totalmente asistida independiente entre ejes :

Delantera : Totalmente hidráulica, controlada por volante.

Trasera : Totalmente hidráulica, controlada por interruptor.

Infinitamente variable en los 4 modos de dirección principales : sólo delantera, sólo trasera, control de giro (tipo cangrejo) y coordinada. Indicador de dirección trasera.

Radio de giro: 6,7 m.



Ejes

Delantero : Tracción/dirección con reducción planetaria y diferencial, montaje rígido en la estructura.

Trasero : Tracción/dirección con reducción planetaria y diferencial, montaje pivotante en la estructura.



Neumáticos

29,5 x 25 - 28 lonas.



Luces

Iluminación completa que incluye intermitentes, indicadores superiores, traseros, de freno y de peligro.



Velocidad máxima

37 km/h.



Inclinación (teórica)

130 % basado en peso bruto del vehículo de 42 388 kg, neumáticos de 29,5 x 25, bombas dedicadas, pluma de 33,6 m, extensión articulada, cable y cabrestante aux. y gancho de 55 t.



Frenos

Circuito de frenos totalmente hidráulico operando sobre todas las ruedas.

Freno de estacionamiento montado sobre el eje delantero que se acciona mediante resorte y se libera hidráulicamente.



Sistema eléctrico

Dos baterías de 12 V sin mantenimiento. Arranque e iluminación de 12V.

Desconexión de la batería

*Equipamiento Opcional

• Paquete de cabrestante auxiliar (incluye cabrestante auxiliar modelo HP30A-19G con indicador electrónico de rotación del tambor del cabrestante, guía del cable del tambor del cabrestante, cable de acero de clase 35 x 7 de 19 mm de 152 m, punta de pluma auxiliar de una sola polea. • Paquete iluminación auxiliar y de conveniencia: incluye luz ámbar intermitente montada en la superestructura, barra de iluminación del indicador de momento de carga dentro de la cabina, dos focos montados en el tramo base de la pluma, alfombrilla de goma para el hueco de almacenaje • Conformidad con el marcado CE • Bloqueos diferenciales de eje cruzado (delantero y trasero) • Desconexión manual de la bomba • Gancho de remolque - trasero • Bloqueo de giro en 360° Tipo NYC • Contrapeso de extracción hidráulica • Indicador 3ª vuelta del cabrestante con función de bloqueo para cabrestante principal o para cabrestante principal y auxiliar • Anemómetro inalámbrico

* Indica equipo opcional. Otros equipos opcionales bajo demanda.

Sovrastruttura

Braccio

Braccio con sfilamento idraulico sequenziale - sincronizzato a quattro sezioni da 11 a 33,5 m. Altezza massima in punta: 36,4 m.

*Jib ripiegabile

Jib tralicciato inclinabile da 10,1 m. Inclinabile a 0°, 25° e 45°. Alloggiabile e trasportabile lungo la sezione di base del braccio telescopico. Altezza massima in punta: 45,8 m.

*Jib doppio ripiegabile

Jib tralicciato ripieghevole inclinabile da 10,1 - 17,1 m. Inclinabile a 0°, 25° e 45°. Alloggiabile e trasportabile lungo la sezione di base del braccio telescopico. Altezza massima in punta: 52,8 m.

*Sezioni intermedie

Sezioni intermedie tralicciate da 6,1 m o 12,2 m. Installabili tra la punta del braccio ed il falcone, non alloggiabili lungo il braccio. Altezza massima in punta: 65,2 m.

Sollevamento braccio

Un cilindro idraulico a doppia azione con valvola di blocco integrale fornisce il sollevamento braccio con angolo da -3° a +78°.

Limitatore di carico e finecorsa

Momento di carico standard con display grafico, sistema anti-doppio bloccaggio con allarme e bloccaggio dei movimenti.

Visualizzazione grafica dell'angolo del braccio, lunghezza, raggio, altezza in punta, indicazione del carico e del carico ammissibile massimo. Il sistema standard di definizione dell'area di lavoro permette all'operatore di preselezionare e definire le aree di lavoro sicure. Se l'autogru si avvicina ai limiti preimpostati, degli allarmi acustici e visivi aiutano l'operatore ad evitare gli ostacoli sul posto di lavoro.

Cabina

Ottima visibilità, costruita completamente in acciaio, insonorizzata. Il sedile ergonomico è dotato di comandi elettrici a doppio asse integrati nei braccioli. Il cruscotto incorpora la strumentazione per tutte le funzioni del motore. Altre caratteristiche standard comprendono: volante inclinabile, riscaldamento ad acqua, ventola per la circolazione dell'aria nella cabina, finestrini scorrevoli, lava/tergicristallo elettrico, estintore e cintura di sicurezza, aria condizionata.

Rotazione

Comando di rotazione planetario con freno a disco multiplo azionato a pedale. Frenorotante azionato a molla, rilasciato idraulicamente e arresto meccanico a una posizione azionato dalla cabina. Velocità massima: 2,5 giri/minuto.

Contrappeso

6 516 kg, fissato mediante perni alla torretta.

Impianto idraulico

Tre pompe principali con capacità totale di 391 l/min (511 l/min con condizionamento dell'aria, opzionale). Pressione operativa massima: 276 bar. Valvola di controllo principale a due sezioni a pressione compensata. Filtro sulla linea di ritorno non bypassabile e indicatore di manutenzione. Cartuccia sostituibile con valore di filtraggio micronico di 5/12/16. Capacità del serbatoio idraulico 500 l. Scambiatore di calore per raffreddamento olio idraulico. Prese per la misura della pressione del sistema.

Specifiche dell'argano principale e ausiliario

Riduttore planetario e freno negativo multidischi ad azionamento automatico. Tamburo scanalato. Indicatore elettronico di rotazione del tamburo sul joystick e guide per cavo tamburo argano.

Tiro massimo con singola fune : 8 246 kg
Tiro massimo permesso sulla fune : 7 620 kg con fune di classe 6X37.
7 620 kg con fune di classe 35X7.

Velocità massima con singola fune : 156 m/min.

Costituzione della fune: 6 x 37 EIPS IWRC,
35x7 Flex-X, antigiro.

Diametro fune : 19 mm.

Lunghezza della fune argano principale: 152 m - optional 168 m

Massima capacità di avvolgimento della fune sul tamburo: 256 m.

CraneSTAR

Sistema di gestione della flotta gru.

Carro

Telaio

Costruzione in sezioni scatolate realizzate in acciaio ad alta resistenza. Casse stabilizzatori integrate e agganci anteriori/posteriori per traino, sollevamento e fissaggio.

Stabilizzatori

Quattro stabilizzatori a sfilo singolo ed azionamento idraulico; cilindri verticali a stelo rovesciato con valvole di blocco integrali. Tre configurazioni di lavoro: 0%, 50% e completamente estesi. Completamente realizzati in acciaio ad alta resistenza, piatti stabilizzatori diametro 610 mm a sgancio rapido. Carico massimo su piatti stabilizzatori: 36 606 kg.

Comandi e indicatore di livellamento della gru situati all'interno della cabina.

Motore

Tier 3 / Euromot 3A: Cummins QSB 6.7 L diesel, sei cilindri, sovralimentato con turbocompressore, 179 kW a 2500 giri/min. Coppia massima: 987 Nm a 1500 giri/min. Nota: richiesto per vendita al di fuori dei paesi del Nord America e dell'Unione Europea.

Tier 4f / Euromot 3B: Cummins QSB 6.7 L diesel, sei cilindri, sovralimentato con turbocompressore, con sistema di post-trattamento costituito dal filtro antiparticolato Cummins DPF, 179 kW a 2500 giri/min. Coppia massima: 990 Nm a 1500 giri/min. Conforme ai requisiti richiesti per le emissioni secondo E.P.A. (United States) Tier IV e EUROMOT (Comunità Europea) Stadio 3B. Carburante richiesto: diesel con contenuto massimo di zolfo 15 ppm (Ultra Low Diesel Fuel). Nota: il motore Tier IV / Euromot 3B è richiesto nei paesi del Nord America e dell'Unione Europea. Capacità serbatoio: 280 l

Cambio

Cambio a 6 rapporti (3 marce x 2 velocità sia in avanti che in retromarcia). Possibilità di esclusione assale anteriore per marcia 4 x 2.

Trazione/Sterzo

4 x 4. Idroguida completamente indipendente:

Anteriore: completamente idraulico azionato tramite il volante.

Posteriore: completamente idraulico azionato con pulsante.

4 modalità di sterzata: solo anteriore, solo posteriore, a granchio e combinata.

Indicatore di allineamento delle ruote posteriori. Raggio di sterzo: 6,7 m.

Assali

Anteriore : Montato rigido sul telaio, trazione con differenziale e mozzi di riduzione planetaria.

Posteriore : Su culla oscillante, trazione con differenziale e mozzi di riduzione planetaria montati.

Pneumatici

29,5 x 25 - 28 strati trasversali.

Luci

Illuminazione completa compresi indicatori di direzione, luci anteriori, posteriori, freno e luci di segnalazione pericolo.

Velocità massima

37 km/h.

Pendenza (teorica)

130 % calcolato su peso lordo di 42 388 kg, pneumatici 29,5 x 25, pompe innescate, braccio da 33,5 m, falcone ripiegabile, argano e cavi ausiliari, bozzello da 55 t.

Freni

Doppio circuito completamente idraulico agente su tutte le ruote.

Freno di stazionamento negativo ad azionamento idraulico agente sull'asse anteriore.

Impianto elettrico

2 batterie da 12 V. Avviamento e illuminazione a 12 V. Interruttore di disconnessione batteria.

* Equipaggiamenti opzionali

- Pacchetto ausiliario di sollevamento (comprende l'argano ausiliario HP30A-19G con indicatore elettronico di rotazione del tamburo, con cedente cavo tamburo di sollevamento, 152 m di fune metallica da 19 mm classe 35 x 7, testa braccio ausiliaria ad una puleggia) • Pacchetto luci ausiliario: comprende luce gialla lampeggiante montata in sovrastruttura, barra luminosa LMI in cabina e riflettori doppi montati sul braccio di base, tappetino in gomma per vano di stivaggio • Marchio CE di conformità • Blocchi differenziale asse trasversale (anteriore e posteriore) • Disconnessione manuale della pompa • Gancio di rimorchio posteriore • Blocco della rotazione a 360° tipo NYC • Rimozione idraulica del contrappeso • Indicatore del terzo avvolgimento sull'argano principale ed ausiliario con funzione di blocco della rotazione • Anemometro wireless.

Características

Superestrutura



Lança

11 m - 33,5 m. Lança de quatro secções, de telescopagem hidráulica, sincronizada. Altura máxima da ponta da lança : 36,4 m.



*Extensão swingaway fixa

Extensão swingaway treliçada com angulação de 10.1 m. Angulações: 0°, 25° e 45°. Pode ser arrumada ao longo da secção de base da lança. Altura máx. da cabeça da extensão: 45,8 m.



*Extensão swingaway de dobragem dupla

Extensão swingaway de 10,1 a 17,1 m da estrutura oscilante bipartida. Angulações de 0°, 25° e 45°. Acondiciona-se ao longo da secção da lança base. Altura máx. da cabeça da extensão: 52,8 m.



*Extensões de lança

Extensões de lança treliçada de 6,1 m ou 12,2 m. Instalação entre a cabeça da lança e a extensão de dobragem dupla, não pode ser arrumada. Altura máxima da ponta da lança: 65,2 m.



Elevação da lança

Um cilindro hidráulico de acção dupla com válvula anti-retorno integral assegura a elevação de -3° a +78°.



Sistema de momento de carga e fim de curso do cadernal

“Indicador gráfico” standard do momento de carga e do sistema de fim de curso do cadernal com sistema audiovisual de sinalização e dispositivo de bloqueio automático das alavancas de comando. Estes sistemas fornecem informações, apresentadas em visor electrónico, do ângulo da lança, do comprimento, do raio, da altura da ponta da lança, do momento de carga relativo, da carga máxima admitida, da indicação de carga e aviso sobre o fim de curso do cadernal. O Sistema de Definição da Área de Trabalho standard permite ao operador seleccionar previamente e definir áreas de trabalho. Se a grua se estiver a aproximar dos limites previamente definidos, avisos audiovisuais ajudam o operador a evitar obstruções no local da obra.



Cabine

Cabine panorâmica, integralmente feita de aço, com isolamento sonoro e vidro de segurança colorido a toda a volta. O assento Deluxe integra controladores de eixo duplo, eléctricos, instalados no apoio para os braços. O painel de controlo está equipado com manómetros para todas as funções do motor. Entre as demais funcionalidades standard incluem-se: Volante inclinável, aquecedor da cabine de água quente, ventoinha de circulação do ar na cabine, janelas lateral e traseira deslizantes, vidro de tejadilho deslizante com limpa-vidros eléctrico e pala para o sol, lava e limpa pára-brisas eléctricos, extintor de incêndios e cinto de segurança, ar condicionado.



Rotação

Unidade de oscilação planetária com travão multi-discos accionado por pedal. Aplicação de mola, travão de oscilação hidráulicamente solto do tipo pistão, uma posição de bloqueio para estacionamento mecânico, operada da cabine. Velocidade máxima : 2,5 rpm.



Contrapeso

6 516 kg fixo à superestrutura.



Sistema hidráulico

Três bombas principais com uma capacidade combinada de 391 LPM (511 LPM com ar condicionado opcional). Pressão de serviço máxima: 276 bar. Dois conjuntos individuais de válvulas de pressão compensada. Filtro no circuito de retorno com protecção por derivação de débito total e indicador de manutenção. Cartucho substituível com classe de filtragem micrométrica de 5/12/16. Depósito de 500 L. Radiador de óleo integral. Tomadas para teste de pressão do sistema.



Guincho

Redutor de planetários com travão em banho de óleo multidiscos de mola, automático. Tambor ranhurado. Indicadores electrónicos da rotação do tambor de elevação e acamador de cabo no tambor de elevação.

Esforço máximo no cabo singelo : 8 246 kg

Esforço máximo admitido no cabo singelo: 7 620 kg com cabo da classe 6x37.

7 620 kg com cabo da classe 35x7

Velocidade máxima do cabo singelo : 156 m/min.

Tipo de Cabo: 6x37 EIPS IWRC.

35x7 Flex-X resistente à rotação.

Diâmetro do Cabo: 19 mm. Comprimento do cabo: Guincho principal: 152 m e

auxiliar: 168 m. Capacidade Máxima do Cabo : 256 m.



CraneSTAR

Sistema de gestão de frotas de gruas.

Chassis



Chassis

Chassis de caixa em aço de alta resistência. Receptáculos integrais dos estabilizadores, reboque dianteiro e traseiro e olhais para elevação.



Estabilizadores

Quatro vigas de estabilização hidráulicas e telescópicas, de caixa dupla, de secção simples, com macacos invertidos e válvulas anti-retorno integrais. Três posições : 0%, 50% e totalmente estendidas. Sapatas de apoio, integralmente feitas de aço, de libertação rápida, diâmetro 610 mm. Carga máxima nas sapatas : 36 606 kg. Comandos de estabilização e indicador de nível instalados no interior da cabine.



Motor

Tier 3 / Euromot 3A: Cummins QSB 6.7 L diesel, seis cilindros, turboalimentado, 179 KW a 2.500 rpm. Binário máximo: 987 Nm a 1500 rpm. Nota: Necessário para nos países fora da América do Norte e da União Europeia.

Tier 4f / Euromot 4: Cummins QSB 6,7 L diesel, seis cilindros, turboalimentado, com silenciador/filtro de partículas diesel Cummins. Respeita os níveis de emissões de acordo com Tier IV da U.S.E.P.A. e classe IIIB da U.E.. 179 KW a 2.500 rpm. Binário máximo: 990 Nm a 1500 rpm. Requisitos relativos ao combustível: máximo de 15 ppm de teor de enxofre (diesel de muito baixo teor em enxofre). Nota: o motor Tier IV é necessário nos países da América do Norte e da União Europeia.

Depósito de 280 l.



Transmissão

Transmissão Spicer Powershift com 6 velocidades de marcha á frente e 6 velocidades de marcha-atrás. Desembraiagem do eixo frontal para deslocação 4 x 2.



Tracção/direcção

4 x 4.

Direcção assistida de comando independente:

À frente : totalmente hidráulica, comandada pelo volante.

Atrás : totalmente hidráulica, comandada por interruptor.

Disponibiliza um número infinito de variações dos 4 principais modos de direcção: só dianteira, só traseira, direcção tipo caranguejo e direcção coordenada. Indicador de direcção traseira. Raio de viragem : 6,7 m.



Eixos

Dianteiros : Eixo de tracção/direcção com cubos do redutor de planetários e diferencial rigidamente montados no chassis.

Traseiros : Eixo de tracção/direcção com cubos do redutor de planetários e diferencial montados no chassis de forma articulada (pivôs).



Pneus

29,5 x 25 - 28 telas.



Iluminação

Conjunto completo, incluindo luzes de sinalização de mudança de direcção, faróis dianteiros, faróis traseiros, luzes de travagem e luzes de sinalização de perigo.



Velocidade máxima

37 km/h.



Gradabilidade (teórica)

130 % baseado em PB 42 388 kg, pneus 29,5 x 25, bombas engatadas, lança 33,5 m, extensão bi-fold, elevação e cabo auxiliar, e bloco de gancho 55 t.



Travões

Travões de circuito dividido, totalmente hidráulicos, que actuam sobre todas as rodas.

Travão de estacionamento de mola e de libertação hidráulica, montada no eixo dianteiro.



Sistema eléctrico

Duas baterias de 12 V que dispensam manutenção. Arranque e luzes de 12 V.

Interruptor de desconexão da bateria.

* Equipamento opcional

• Pacote de guincho auxiliar (inclui guincho auxiliar HP30A-19G com indicador electrónico de rotação do tambor do guincho, guia do cabo do tambor do guincho, cabo de aço classe 35x8 de 19 mm de 152 m, cabeça da lança auxiliar de uma única roldana. • Pacote de iluminação auxiliar e de conveniência: inclui pirilampo rotativo montado na superestrutura, barra de iluminação do LMI (Indicador de momento de carga) no interior da cabine, dois focos montados no tramo base da lança e protecção em borracha da zona de armazenagem. • Conformidade com a marca CE. • Bloqueios diferenciais do eixo cruzado (dianteiro e traseiro) • Desconexão manual da bomba • Gancho de reboque traseiro • Bloqueio da rotação a 360° tipo NYC • Contrapeso removível hidráulicamente • Indicador de enrolamento da 3ª camada com função de bloqueio para os guinchos principal e auxiliar. • Anemómetro sem fios.

* Assinala o equipamento opcional. Outros opcionais sob pedido

Крановая установка

 **Стрела**
четырёхсекционная телескопическая стрела длиной 11 – 33,5 м с синхронизированным выдвижением. Максимальная высота оголовка стрелы: 36,4 м.

 ***Удлиннитель стрелы**
Двойной решетчатый удлиннитель стрелы 10,1 м. Возможность установки под углом в 0°, 25° или 45°. Складывается вдоль секции основной стрелы. Максимальная высота оголовка удлинителя: 45,8 м.

 ***Фиксированный удлиннитель стрелы**
складной решетчатый удлиннитель стрелы 10,1 – 17,1 м. Возможность установки под углом в 0°, 20° или 40°. Складывается вдоль секции основной стрелы. Максимальная высота оголовка удлинителя: 52,8 м.

 ***Вставки**
Решетчатые удлинительные вставки длиной 6,1 или 12,2 (6,1x2) м. Устанавливаются между оголовком стрелы и удлинителем. Не складываются. Максимальная высота подъема: 65,2 м.

 **Угол наклона стрелы**
Один гидравлический цилиндр двойного действия со встроенным обратным клапаном обеспечивает угол подъема от -3° до +78°.

 **Ограничитель грузового момента и ограничитель высоты подъема крюка**
Стандартный ограничитель грузового момента с графическим дисплеем и системой блокировки при переподъеме с звуковой и визуальной сигнализацией и блокировкой органов управления. Эти системы выводят на электронный дисплей угол наклона стрелы, длину, радиус, высоту оголовка стрелы, относительный грузовой момент, максимальную допустимую нагрузку, текущую нагрузку и предупреждение о возможности перегруза. Стандартная система ограничения радиусов зоны позволяет оператору выбрать и определить безопасные радиусы зоны. При приближении к радиусу установленным образом издаются звуковые и визуальные сигналы предупреждения оператора.

 **Кабина**
Полностью стеклянная кабина с круговым обзором, звукоизоляцией и тонированными небьющимися стеклами по всему периметру. Высококвалифицированное сиденье оборудовано встроенными в подлокотники органами управления с одноосевым перемещением. Контрольные приборы для всех радиальных функций выведены на приборную панель. Остальные опции, включенные в стандартную комплектацию: обогреватель и горячая вода, вентилятор, подвижные боковые и задние стекла, подвижные задние стекла на крыше с электрическим стеклоочистителем и солнцезащитным экраном, электроомыватель и очиститель лобового стекла, огнетушитель и ремень безопасности, воздушный кондиционер.

 **Поворот**
Полностью независимый поворотный привод со стояночным мультидисковым тормозом. Пружинный гидравлический высвобождаемый плунжерный тормоз механизма поворота крана, однопозиционный механический центральный замок, управляемый из кабины. Максимальная скорость: 2,5 об./мин.

 **Противовес**
6516 кг; 3 крепленных поворотной платформе.

 **Гидравлическая система**
3 главных насоса общей производительностью 391 л/мин (511 л/мин при заказе системы кондиционирования воздуха). Максимальное давление: 276 бар. Две независимые группы радиальных клапанов. Фильтр возвратной магистрали с полнопоточной обходной защитой и индикатором обслуживания. Сменная секция с минимальным размером частиц, удельных фильтром, 5/12/16. Гидробак на 500 л. Встроенный сливочиститель. Контрольные отверстия для проверки давления системы.

 **Лебедка подъема**
Полностью гидравлическая с автоматическим пружинным многодисковым жидкохолодным тормозом. Желобчатый барабан. Электронные индикаторы вращения подъемного барабана и кабельные держатели. Максимальное натяжение каната при однократной загрузке: 8246 кг. Максимально допустимое натяжение каната: 7620 кг/секунда в том числе 6X37. 7620 кг с устойчивым скручиванием каната в том числе 35X7. Максимальная скорость каната при однострунной установке: 156 м/мин. Конструкция каната: 6X37 с сердечником из высокопрочной стали для подъемных канатов особой гибкости, высококачественных. 35x7 Flex-X, устойчивый к скручиванию. Диаметр каната: 19 мм. Длина каната: Лебедка основного подъема: 152 м - Лебедка вспомогательного подъема: 168 м. Максимальная длина укладываемого каната: 256 м.

 **CraneSTAR**
Система управления ресурсом крана.
RT765E-2

Тягач

 **Шасси**
Коробчатая рама выполнена из высокопрочной низколегированной стали. Интегрированные гнезда домкратов и фронтальные/задние уши для буксировки, подъема и крепления.

 **Выносные опоры**
Четыре гидравлические телескопические одноступенчатые двухмуфтовые блокные выносные опоры с перевернутыми цилиндрами и встроенными блокирующими клапанами. Три позиции выдвижения: 0%, 50% и полная длина. Стальные, легко доступные опоры диаметром 610 мм. Максимальная нагрузка на груз и подушку выносной опоры: 36606 кг. Органы управления и указатели уровня крана расположены в кабине.

 **Двигатель**
Tier 3 / Euromot 3A: Дизельный Cummins QSB 6,7 л, 6-цилиндровый, с турбонагнетателем и выхлопным фильтром/шумоглушителем Cummins Diesel Particulate. Соответствует требованиям U.S.E.P.A. Tier IV и E.U. Stage III B, мощность 179 кВт при 2500 оборотах/мин. Максимальный крутящий момент: 987 Н*м при 1500 оборотах/мин. Примечание: Tier III - нормативные требования для продаж вне Европейского Союза и Северной Америки.

Tier 4f / Euromot 4: Дизельный Cummins QSB 6,7 л, 6-цилиндровый, с турбонагнетателем и выхлопным фильтром/шумоглушителем Cummins Diesel Particulate. Соответствует требованиям U.S.E.P.A. Tier IV и E.U. Stage III B, мощность 179 кВт при 2500 оборотах/мин. Максимальный крутящий момент: 990 Н*м при 1500 оборотах/мин. Требования для горючего: максимальное содержание серы 15 частей на миллион (дизельное топливо с ультранизким содержанием серы) Примечание: двигатель Tier IV - нормативные требования для продаж в Европейском Союзе и Северной Америке. Емкость топливного бака: 280 л.

 **Трансмиссия**
Коробка переключения передач Spicer с 6 передними и 6 задними скоростями. Отключение переднего моста для передвижения в режиме 4x2.

 **Ведущие / Управляемые оси**
4x4. Полностью независимое рулевое управление с усилителем. Передние: С полным гидравлическим усилением. Управление от рулевого колеса. Задние: С полным гидравлическим усилением. Ручное управление с помощью переключателя. Возможны многочисленные варианты 4 основных режимов рулевого управления: только передние, только задние, крестовый ход и полный режим. Индикатор заднего движения. Радиус разворота: 6,7 м.

 **Оси**
Передняя: Ведущая с управляемыми колесами, с дифференциальными планетарными колесными редукторами, жестко смонтированными на раму. Задняя: Ведущая с управляемыми колесами, с дифференциальными и планетарными колесными редукторами, шарнирно-сочлененными на раму.

 **Шины**
29,5 x 25 - 28 с дисковым кордом.

 **Фары**
Полное освещение, включая индикаторы поворота, передние, задние, тормозные фонари и лампы в аварийной сигнализации.

 **Максимальная скорость**
37 км/ч.

 **Преодолеваемый уклон (теор.)**
130% на базе 42388 кг (полная масса), шины 29,5 x 25, с использованием немаслянистых шин 33,6 м, двойной складной гусек, лебедка вспомогательного подъема к кабелему и крюковому блоку 55 т.

































 **Тормоза**
Полностью гидравлические, радиальные на все колеса. Пружинный гидравлический отпускатель парковочного тормоза, с закрепленным на передней оси.

 **Электросистема**
Две, не требующие обслуживания, батареи на 12 В. Напряжение запуска и освещения - 12 В. Отключение батареи. Выключение батареи.

***Дополнительное оборудование (по выбору)**
• Вспомогательный подъемный механизм (HP30A-19G) вспомогательный подъемник с электронным индикатором барабана и подъемной машиной, следующим элементом барабана и подъемной машиной, 152 м 19 мм стального троса с 35x7, вспомогательного одиночного шкива и кончик стрелы крана. • Вспомогательный комплект для освещения и комфорта: состоит из установленного на канатной опоре осветительного фонаря ночного освещения, лампы поворотной нелинейной в кабине, смонтированных в стрелу осветительных прожекторов двойной основе, трех резиновых ковров. • Отметка соответствия стандарту CE. • Задний межколесный дифференциальный (передний и задний) • Ручное отключение на шоссе • Цепной крюк - задний • 360° фиксированный поворот (по часовой стрелке) тип NYC • Гидравлический съёмный противовес • Задний моток с функцией блокировки главного подъемника или главного и вспомогательного подъемника • Беспроводной датчик скорости ветра.

Notes • Hinweise • Notes • Notas • Note • Примечания

Symbols • Symbolerklärung • Glossaire des symboles • Glosario de simbolos • Glossario dei simboli • Simbolos • Символы

	Axles Achsen Ponts Ejes Assali Оси		Counterweight Gegengewicht Contrepoids Contrapeso Contrappeso Противовес		Main hoist Haupthubwerk Treuil principal Cabrestante principal Argano principale Лебедка основного подъема		Outriggers Abstützung Calage Estabilizadores Stabilizzatori Выносные опоры
	Axle load Achslast Charge à l'essieu Carga por eje Carico sugli assi Нагрузка на ось		Crane functions Kranbewegungen Mouvements de la grue Funciones de la grúa Funzioni della gru Функции крана		Auxiliary hoist Hilfshubwerk Treuil auxiliaire Cabrestante auxiliar Argano secondario Лебедка вспомогательного подъема		Radius Ausladung Portée Radio Raggio Вылет
	Boom Ausleger Flèche Pluma Braccio Стрела		Crane travel Fahrstellung Déplacement de la grue Grúa en traslado Traslazione gru Перемещение крана		Hookblock / Capacity Hakenflasche / Traglast Moufle / Force de levage Gancho / Capacidad Gancio / Capacità Крюковой блок / Грузоподъемность		Slewing/Working range Drehwerk/Arbeitsbereich Orientation/Rayon d'opération Giro/Gama de trabajo Rotazione/Area di lavoro Поворот/ Рабочий диапазон
	Boom elevation Wippwerk Relevage Elevación de pluma Elevazione braccio Подъем стрелы		Drive/Steer Antrieb/Lenkung Direction/Déplacement Tracción/Dirección Trazione/Sterzo Ведущие/Управляемые оси		Hydraulic system Hydrauliksystem Circuit hydraulique Sistema hidráulico Impianto idraulico Гидравлическая система		Speed Geschwindigkeit Vitesse Velocidad Velocità Скорость
	Boom telescoping Teleskopieren Télescopage de flèche Telescopaje de pluma Lunghezza braccio Выдвижение стрелы		Electrical system Elektrische Anlage Circuit électrique Sistema eléctrico Impianto elettrico Электросистема		Lattice extension Gitterspitze Extension treillis Extensión de celosía Falcone tralicciato Гусек		Suspension Federung Suspension Suspensión Sospensioni Подвеска
	Brakes Bremsen Freins Frenos Freni Тормоза		Engine Motor Moteur Motor Motore Двигатель		Lattice extension (luffing) Gitterspitze (wippbar) Extension treillis (volée variable) Extensión de celosía (angulable hidráulicamente) Falcone tralicciato (inclinabile) Гусек (с изменением вылета)		Transmission / Gear Getriebe / Gang Boîte de vitesses / Rapport Transmisión / Cambio Trasmissione / Cambio Трансмиссия / передача
	Cab Kabine Cabine Cabina Cabina Кабина		Free on wheels Freistehend Sur pneus Sobre neumáticos Su gomme Свободные внутренние колеса		Luffing Jib Wippspitzenausleger Volée variable Plumín angulable Falcone a volata variabile Маневровый гусек		Travel speed Fahrgeschwindigkeit Vitesse de déplacement Velocidad de desplazamiento Velocità di traslazione Скорость движения
	Carrier frame Chassis-Rahmen Châssis porteur Bastidor Telaio Рама тягача		Gradeability Steigfähigkeit Aptitude en pente Superación de pendientes Pendenza superabile Преодолеваемый уклон		Low range Kriechgang Gamme basse Marchas cortas Fuoristrada Низкий диапазон		Tyres Bereifung Pneumatiques Neumáticos Pneumatici Шины

Manیتowoc Cranes

Regional headquarters

Americas

Manیتowoc, Wisconsin, USA

Tel: +1 920 684 6621

Fax: +1 920 683 6277

Shady Grove, Pennsylvania, USA

Tel: +1 717 597 8121

Fax: +1 717 597 4062

Europe, Middle East, Africa

Dardilly, France

Tel: +33 (0)4 72 18 20 20

Fax: +33 (0)4 72 18 20 00

China

Shanghai, China

Tel: +86 21 6457 0066

Fax: +86 21 6457 4955

Greater Asia-Pacific

Singapore

Tel: +65 6264 1188

Fax: +65 6862 4040

Regional offices

Americas

Brazil

Alphaville

Mexico

Monterrey

Chile

Santiago

Europe, Middle East, Africa

France

Baudemont

Cergy

Decines

Germany

Langenfeld

Italy

Lainate

Netherlands

Breda

Poland

Warsaw

Portugal

Baltar

Russia

Moscow

South Africa

Johannesburg

U.A.E.

Dubai

U.K.

Buckingham

China

Beijing

Chengdu

Guangzhou

Xian

Greater Asia-Pacific

Australia

Brisbane

Melbourne

Sydney

India

Chennai

Delhi

Hyderabad

Pune

Korea

Seoul

Philippines

Makati City

Singapore

Factories

Brazil

Passo Fundo

China

TaiAn

Zhangjiagang

France

Charlieu

Moulins

Germany

Wilhelmshaven

India

Pune

Italy

Niella Tanaro

Portugal

Baltar

Fânzeres

USA

Manیتowoc

Port Washington

Shady Grove

This document is non-contractual. Constant improvement and engineering progress make it necessary that we reserve the right to make specification, equipment, and price changes without notice. Illustrations shown may include optional equipment and accessories and may not include all standard equipment.

Die Angaben in diesem Dokument erfolgen ohne Gewähr. Wir verbessern unsere Produkte ständig und integrieren den technischen Fortschritt. Aus diesem Grund behalten wir uns das Recht vor, die technischen Daten, die Ausstattungsdetails und die Preise unserer Maschinen ohne Vorankündigung zu ändern.

Ce document est non-contractuel. Du fait de sa politique d'amélioration constante de ses produits liée au progrès technique, la Société se réserve le droit de procéder sans préavis à des changements de spécifications, d'équipement ou de prix. Les illustrations peuvent comporter des équipements ou accessoires optionnels ou ne pas comporter des équipements standards.

Este documento no es contractual. El perfeccionamiento constante y el avance tecnológico hacen necesario que la empresa se reserve el derecho de efectuar cambios en las especificaciones, equipo y precios sin previo aviso. En las ilustraciones se puede incluir equipo y accesorios opcionales y es posible que no se muestre el equipo normal.

Documento non contrattuale. In considerazione della sua politica di costante miglioramento dei prodotti connesso al progresso tecnico, la Società si riserva il diritto di modificare senza preavviso specifiche, equipaggiamenti o prezzi. Le illustrazioni possono contenere equipaggiamenti o accessori optional o non contenere equipaggiamenti standard.

Este documento não se reveste de qualquer carácter contratual. A introdução constante de melhorias e o progresso da engenharia tornam necessário reservarmos o direito de introduzir alterações nas características técnicas, no equipamento e no preço sem qualquer aviso prévio. As ilustrações aqui apresentadas podem incluir equipamento e acessórios adicionais, podendo não incluir todo o equipamento padrão.

Данный документ не является контрактным. Принимая во внимание необходимость постоянного совершенствования и модернизации мы оставляем за собой право изменять спецификации, конструкции и стоимость без предварительного уведомления. Приведенные иллюстрации могут содержать дополнительные компоненты и принадлежности, не входящие в стандартный комплект поставки оборудования.