





Grove RT9150E

Product guide



-  135 t
-  60,0 m
-  11,0 - 18,0 m
-  95,3 m



**Rough Terrain Crane • Geländekran • Grue Tout-Terrain
Grúa Todo Terreno • Autogru Fuoristrada • Grua RT
Кран для использования на пересеченной местности**

Features • Besonderheiten • Caractéristiques • Características Caratteristiche • Características • Особенности



- **MEGAFORM™ boom** - The Grove MEGAFORM™ boom shape eliminates weight and increases capacity compared to conventional shapes. Large wear pads provide superior boom alignment when telescoping, and allow an excellent transition of weights between sections.
- **MEGAFORM™ Ausleger** - Durch das spezielle Design des MEGAFORM™-Auslegers kann im Vergleich zu konventionellen Auslegern Gewicht eingespart und Leistung gesteigert werden. Große Gleitstücke sorgen für eine optimale Ausrichtung des Auslegers beim Ausfahren und ermöglichen eine ausgezeichnete Verteilung des Gewichts zwischen den Teleskopteilen.
- **Flèche MEGAFORM™** - La forme de la flèche Grove MEGAFORM™ réduit le poids et augmente la capacité par rapport aux formes conventionnelles. Les grandes plaques d'usure optimisent l'alignement de la flèche lors du télescopage et permettent une excellente répartition des charges entre les sections.
- **Pluma MEGAFORM™** - La pluma con forma Grove MEGAFORM™ reduce peso y aumenta la capacidad en comparación con las formas convencionales. Las grandes placas de desgaste proporcionan una mejor alineación de la pluma durante la extensión y permiten una excelente transición de pesos entre las secciones.
- **Braccio MEGAFORM™** - La sezione del braccio Grove MEGAFORM™ riduce il peso e aumenta la capacità rispetto alle configurazioni convenzionali. I pattini di scorrimento di grandi dimensioni garantiscono un allineamento del braccio telescopico di livello superiore e consentono una transizione eccellente dei pesi tra le sezioni.
- **Lança MEGAFORM™** - A forma MEGAFORM™ das lanças Grove proporciona uma redução de peso e um aumento de capacidade quando comparado com as formas tradicionais. As grandes placas de desgaste fornecem um melhor alinhamento da lança quando da telescopagem, permitindo uma excelente repartição dos pesos entre as secções.
- **Кран на вседорожном шасси MEGAFORM™ boom** - The Grove Модель MEGAFORM™ boom снижает вес и увеличивает грузоподъемность по сравнению со стандартными моделями. Большая поворотная опора обеспечивает идеальное выравнивание стрелы во время юстировки и превосходное перемещение грузов между секциями

- **TWIN-LOCK™ boom pinning system**: Using only one telescope cylinder to extend the boom, Grove's TWIN-LOCK™ system maximizes capacities by eliminating weight inside the extended boom.
- **TWIN-LOCK™ Ausleger-Verriegelungssystem**: Durch die Verwendung von nur einem Teleskopzylinder zum Ausfahren des Auslegers optimiert das TWIN-LOCK™ System von Grove die Leistungen durch Gewichtseinsparungen innerhalb des ausgefahrenen Auslegers.
- **Système de brochage de flèche TWIN-LOCK™**: En utilisant un seul vérin pour télescoper la flèche, le système TWIN-LOCK™ de Grove optimise les capacités tout en réduisant le poids à l'intérieur de la flèche télescopée.
- **Sistema de anclaje de pluma TWIN-LOCK™**: Al utilizar un único cilindro telescópico para extender la pluma, el sistema Grove TWIN-LOCK™ maximiza las capacidades eliminando el peso en el interior de la pluma extendida.
- **Sistema di spinatura delle sezioni braccio TWIN-LOCK™**: Utilizzando un solo cilindro telescopico per estendere il braccio, il sistema Grove TWIN-LOCK™ potenzia la capacità eliminando il peso all'interno del braccio esteso.
- **Sistema de encavilhamento da lança TWIN-LOCK™**: Ao utilizar um único cilindro telescópico para estender a lança, o sistema Grove TWIN-LOCK™ maximiza as capacidades através da eliminação de peso no interior da lança estendida.
- **Система фиксации стрелы TWIN-LOCK™**: Используя только один телескопический цилиндр для удлинения стрелы, система TWIN-LOCK™ Grove обеспечивает максимальную грузоподъемность путем снижения веса внутри выдвигаемой стрелы.



- **Extension**: 11,0 m – 18,0 m hydraulically offsettable bi-fold swing away extension. Provides a total tip height of 81,4 m.
- **Verlängerung**: 11,0 m – 18,0 m durch eine hydraulisch abwinkelbare Doppelklappspitze. Für eine maximale Arbeitshöhe von 81,4 m.
- **Extension**: Extension à double repliage latéral de 11,0 m à 18,0 m avec possibilité de déport hydraulique. Permet une hauteur totale de tête de flèche de 81,4 m.
- **Extensión**: Extensión abatible articulada en dos secciones de 11,0 - 18,0 m., angulable hidráulicamente. Proporciona una altura de la punta al suelo de 81,4 m.
- **Prolunghe**: Falcone tralicciato ripieghevole da 11 m a 18 m inclinabile idraulicamente. Fornisce un'altezza massima in punta di 81,4 m.
- **Extensão**: Extensão dupla articulada de 11,0 m – 18,0 m, dobrável lateralmente e angulável hidráulicamente. Proporciona uma altura desde a ponta ao solo de 81,4 m.
- **Удлинение стрелы**: Гидравлически высвобождаемое двухсекционное поворотное удлинение 11,0 м -18,0 м. Обеспечивает максимальную высоту конца стрелы 81,4 м.

Features • Besonderheiten • Caractéristiques • Carasterísticas Caratteristiche • Carasterísticas • Особенности



- **Full vision cab:** New full-vision cab, all-steel fabricated with acoustical lining and tinted safety glass throughout. The cab tilts up to 20° providing the operator additional comfort when working at long boom and extension lengths.
- **Rundumsichtkabine:** Neue Rundumsichtkabine, in Stahlblech ausgeführt mit Schalldämmung und rundum mit getöntem Sicherheitsglas. Die Kabine lässt sich um bis zu 20° neigen und bietet dem Bediener so zusätzlichen Komfort bei Arbeiten mit langem Ausleger und Verlängerung.
- **Cabine panoramique :** Nouvelle cabine panoramique tout acier, fabriquée avec une isolation sonore et un vitrage teinté de sécurité sur tout le pourtour. La cabine bascule jusqu'à 20° pour apporter à l'opérateur un confort supplémentaire lors du travail avec de grandes longueurs de flèche et d'extension.
- **Cabina de visión panorámica:** nueva cabina de visión panorámica, fabricada totalmente en acero con revestimiento acústico y cristal de seguridad en toda ella. La cabina se inclina hasta 20° para mayor comodidad del operario cuando trabaja con la pluma larga y tramos de extensión.
- **Cabina "Full Vision":** Nuova cabina ad ampia visibilità, completamente realizzata in acciaio con rivestimento acustico e vetri di sicurezza colorati. La cabina si inclina fino a 20° per fornire all'operatore ulteriore comfort quando lavora con braccio esteso e prolunghie del braccio.
- **Cabina panorâmica:** Nova cabina panorâmica, que permite uma visibilidade completa, fabricada integralmente em aço com isolamento acústico e vidro de segurança escurecido. Cabina inclinável até 20°, permitindo ao operador maior conforto quando a grua está a trabalhar com comprimentos de lança maiores ou com as extensões adicionais.
- **Кабина с полным обзором:** новая кабина с полным обзором, полностью стальная с полной акустической облицовкой и тонированным предохранительным стеклом. Кабина наклоняется до 20°, обеспечивая оператору дополнительный комфорт при работе с длинной стрелой и вставкой.

- **Removable outrigger boxes:** Removable front and rear outrigger boxes provides up to 8552 kg of weight reduction for transportation.
- **Demontierbare Abstützung:** Demontierbare Abstützung vorne und hinten sorgt für eine Gewichtseinsparung beim Transport von bis zu 8552 kg.
- **Caissons de calage amovibles :** Les boîtiers amovibles avant et arrière des poutres de calage permettent une réduction de poids allant jusqu'à 8552 kg pour le transport.
- **Cajas de estabilizadores extraíbles:** Cajas de estabilizadores delantero y trasero extraíbles que proporcionan hasta 8552 kg menos de peso para facilitar el transporte.
- **Casse stabilizzatori rimovibili:** Le casse rimovibili degli stabilizzatori anteriori e posteriori permettono una riduzione di peso per il trasporto fino a 8552 kg.
- **Caixas de estabilizadores removíveis:** As caixas dos estabilizadores dianteiros e traseiros removíveis permitem uma redução do peso de transporte até 8552 kg.
- **Отводные лапы домкратов:** Отводные задние и передние лапы домкратов обеспечивают снижение веса для перемещения до 8552 кг



CraneSTAR
EQUIPPED

- **CraneSTAR** is an exclusive and innovative crane asset management system that helps improve your profitability and reduce costs by remotely monitoring critical crane data. Visit www.cranestar.com for more information.
- **CraneSTAR** ist ein exklusives und innovatives Kran-Überwachungssystem, das Ihnen hilft, per Fernüberwachung Kran-Daten abzurufen und somit Ihre Profitabilität zu steigern und Kosten zu reduzieren. Mehr Informationen unter www.cranestar.com.
- **CraneSTAR** est un système exclusif et innovant de gestion de parc de grues qui contribue à améliorer la rentabilité et à réduire les coûts en surveillant à distance les données cruciales des grues. Visitez www.cranestar.com plus de plus amples informations.
- **CraneSTAR** es un sistema exclusivo e innovador de gestión de flotas de grúas que ayuda a mejorar la rentabilidad y reducir los costes controlando a distancia los datos críticos de la grúa. Más información en www.cranestar.com
- **CraneSTAR** è un esclusivo e innovativo sistema di gestione del parco mezzi che aiuta a migliorare la redditività e ridurre i costi attraverso il monitoraggio remoto dei dati critici dell'autogru. Visitare il sito www.cranestar.com per ulteriori informazioni.
- **CraneSTAR** é um sistema exclusivo e inovador de gestão de frotas de gruas que ajuda a melhorar a sua rentabilidade e a reduzir os custos ao monitorizar à distância os dados mais importantes da grua. Mais informação em www.cranestar.com.
- **CraneSTAR** - это эксклюзивная инновационная система управления ресурсом подъемного крана, которая позволяет увеличить производительность и сократить расходы путем постоянного дистанционного наблюдения за критическими данными подъемного крана. Посетите сайт www.cranestar.com для получения дополнительной информации.

Contents • Inhalt • Contenu • Contenido Contenuto • Índice • Содержание

Features • Besonderheiten • Caractéristiques • Caratteristiche	
Características • Características • Осоюенности	2
Dimensions • Abmessungen • Encombremment • Dimensiones • Dimensioni • Dimensões • Размеры	5
Data • Daten • Caractéristiques • Datos • Dati • Características • Данные	6
Load charts • Traglasten • Capacités de levage • Capacidades • Capacità • Diagramas de carga	
Таблицы грузоподъемности	
Working Range • Arbeitsbereiche • Diagramme de levage • Gama de trabajo • Area di lavoro • Area de trabalho	
Грузовысотные характеристики	8
Telescopic Boom • Teleskopausleger • Flèche principale • Pluma telescópica • Braccio telescopico	
Lança telescópica • Телескопическая стрела	9
Manual bifold swingaway • Manuelle Doppelklappspitze • Extension à double repliage latéral manuel	
• Extensión abatible, manual, articulada en dos secciones • Falcone ripieghevole meccanico	
• Extensão dupla articulada, manual • Ручной двухсекционный вывод	15
Hydraulic bifold swingaway • Hydraulische Doppelklappspitze • Extension à double repliage latéral hydraulique	
• Abatible, hidráulica, articulada en dos secciones • Falcone ripieghevole idraulico	
• Extensão dupla articulada, hidráulica • Гидравлический двухсекционный вывод	17
Manual bifold swingaway with inserts • Manuelle Doppelklappspitze mit Verlängerungen • Double repliage latéral manuel avec éléments intermédiaires • Abatible manual, articulada en dos secciones, con inserciones	
• Falcone ripieghevole meccanico con inserti • Extensão dupla articulada, manual, com inserções • Ручной двухсекционный вывод с вставками	18
Manual bifold swingaway • Manuelle Doppelklappspitze • Extension à double repliage latéral manuel	
• Extensión abatible, manual, articulada en dos secciones • Falcone ripieghevole meccanico	
• Extensão dupla articulada, manual • Ручной двухсекционный вывод	19
Hydraulic bifold swingaway • Hydraulische Doppelklappspitze • Extension à double repliage latéral hydraulique	
• Abatible, hidráulica, articulada en dos secciones • Falcone ripieghevole idraulico • Extensão dupla articulada, hidráulica • Гидравлический двухсекционный вывод	20
Manual bifold swingaway with inserts • Manuelle Doppelklappspitze mit Verlängerungen	
• Double repliage latéral manuel avec éléments intermédiaires • Abatible manual, articulada en dos secciones, con inserciones • Falcone ripieghevole meccanico con inserti • Extensão dupla articulada, com inserções	
• Ручной двухсекционный вывод с вставками	21
Weight reductions • Gewichte der Lastaufnahmemittel • Reductions de charge	
Reduccion de peso • Riduzioni di peso • Reduções de peso • Снижение веса	22
Notes • Hinweise • Notes • Notas • Note • Notas • Примечания	23
Specifications	24
Technische Daten	25
Caractéristiques techniques	26
Características técnicas	27
Caratteristiche tecniche	28
Características técnicas	29
Технические характеристики	30
Symbols • Symbolerklärung • Glossaire des symboles • Glosario de símbolos • Glossario dei simboli • Símbolos	
СИМВОЛЫ	31



Manitowoc Crane Care is the Manitowoc's unparalleled product support organisation. Manitowoc Crane Care combines all aspects of parts, service, technical documentation, technical support and training into one organisation. The program includes all of the Manitowoc's brands, which include, Potain, Grove, Manitowoc and National Crane.

For the care of your crane and the prosperity of your business, Manitowoc Crane Care is your single source for customer support. Wherever, whenever, whatever – we're there.

Manitowoc Crane Care vereint alle Serviceleistungen von Manitowoc im Produktsupport vor und nach dem Verkauf: Ersatzteile, Service, technische Dokumentation, technischer Support und Schulung, alles unter einem Dach. Dieser Service erstreckt sich auf alle Marken von Manitowoc: Potain, Grove, Manitowoc und National Crane.

Manitowoc Crane Care è l'ineguagliabile organizzazione di supporto di Manitowoc. Manitowoc Crane Care gestisce tutte le attività legate a pezzi di ricambio, documentazione tecnica, assistenza tecnica e formazione riunite in un unico punto di riferimento. Questo servizio è attivo per tutti i marchi di Manitowoc e precisamente Potain, Grove, Manitowoc e National Crane.

Damit Ihr Kran leistungsfähig bleibt und Ihr Erfolg gesichert ist, bietet Ihnen Manitowoc Crane Care einen umfassenden Support aus einer Hand. Zu jeder Zeit, an jedem Ort, für jeden Fall – wir sind für Sie da.

Organisation hors pair dédiée au support technique des produits de Manitowoc, Manitowoc Crane Care réunit au sein d'une même entité tous les aspects du service : pièces de rechange, service après-vente, publication technique, assistance technique et formation. Ce programme s'adresse à toutes les marques de Manitowoc : Potain, Grove, Manitowoc et National Crane.

Pour assurer l'entretien de vos grues et la prospérité de votre entreprise, Manitowoc Crane Care constitue votre unique interlocuteur du service à la clientèle. Où que vous soyez, quel que soit votre besoin, vous pouvez toujours compter sur nous !

Manitowoc Crane Care, es la organización de post-venta y soporte técnico de Manitowoc. Manitowoc Crane Care combina todos los aspectos relacionados con piezas de repuesto, servicio, documentación técnica, apoyo técnico y formación en una sola organización. El programa también incluye todas las marcas que Manitowoc engloba: Potain, Grove, Manitowoc y National Crane.

Para el cuidado de su grúa y la prosperidad de su negocio, Manitowoc Crane Care, es la forma más sencilla de ayudarle. Donde sea y cuando sea, nosotros estamos allí.

Manitowoc Crane Care è l'ineguagliabile organizzazione di supporto di Manitowoc. Manitowoc Crane Care gestisce tutte le attività legate a pezzi di ricambio, documentazione tecnica, assistenza tecnica e formazione riunite in un unico punto di riferimento. Questo servizio è attivo per tutti i marchi di Manitowoc e precisamente Potain, Grove, Manitowoc e National Crane.

Per l'assistenza delle Vostre gru e per la redditività dei Vostri investimenti, Manitowoc Crane Care è l'insostituibile Vostra risorsa. In ogni posto, tutte le volte, per qualsiasi necessità – noi ci siamo.

Organização verdadeiramente impar dentro da Manitowoc Crane Group, é à Manitowoc Crane Care que compete a responsabilidade pelo suporte técnico dos nossos produtos. Ela reúne, numa mesma entidade, todos os aspectos do serviço: peças de substituição, serviço pós-venda, documentação técnica, suporte técnico e formação. Este programa abrange todas as marcas do Manitowoc Crane Group: Potain, Grove, Manitowoc e National Crane.

Para assegurar a manutenção cuidada das suas gruas e a prosperidade do seu negócio, o seu único interlocutor do serviço de clientes é a Manitowoc Crane CARE. Esteja onde estiver, sejam as horas que forem, precise do que precisa, pode sempre contar conosco!

Manitowoc Crane Care - это не имеющая аналогов организация, входящая в Manitowoc и осуществляющая техническую поддержку продукции. Manitowoc Crane Care занимается всеми аспектами, связанными с запасными частями, услугами, технической документацией, технической поддержкой и обучением. Программа включает все торговые марки Manitowoc, в том числе, Potain, Grove, Manitowoc и National Crane.

Manitowoc Crane Care является единой точкой контактов для всех клиентов компании, где они могут получить полное обслуживание для используемых ими кранов, что, в свою очередь, обеспечит процветание их бизнеса. Мы всегда там и в тот момент, где и когда мы необходимы.

Dimensions • Abmessungen • Encombrement • Dimensiones Dimensioni • Dimensões • Размеры

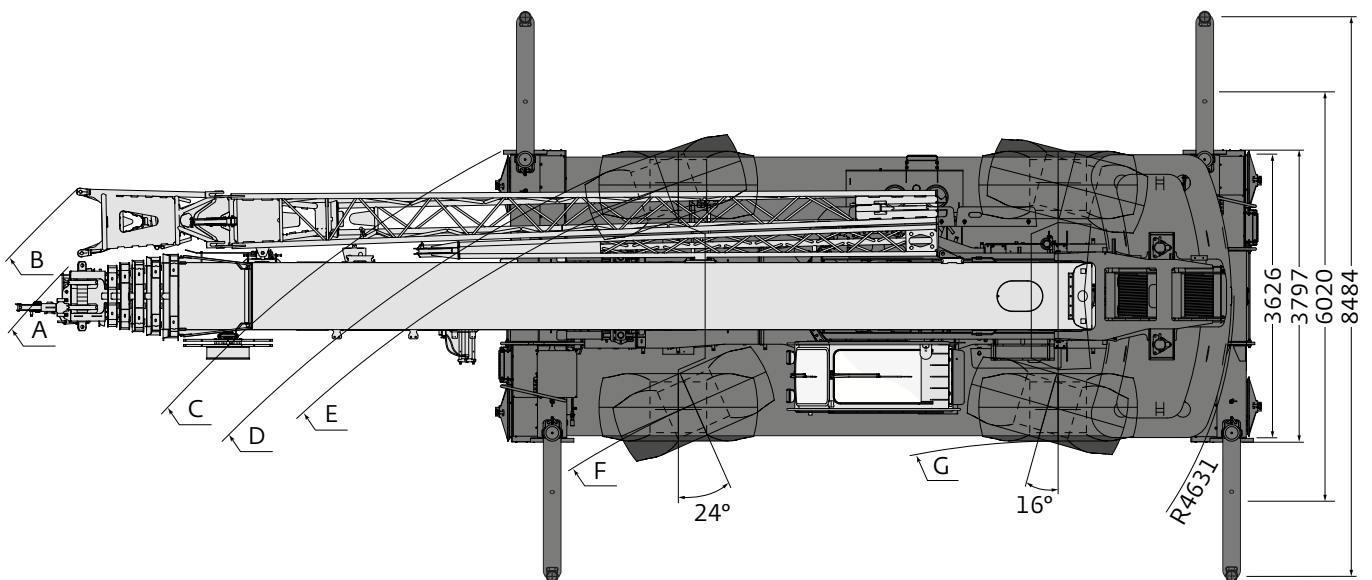
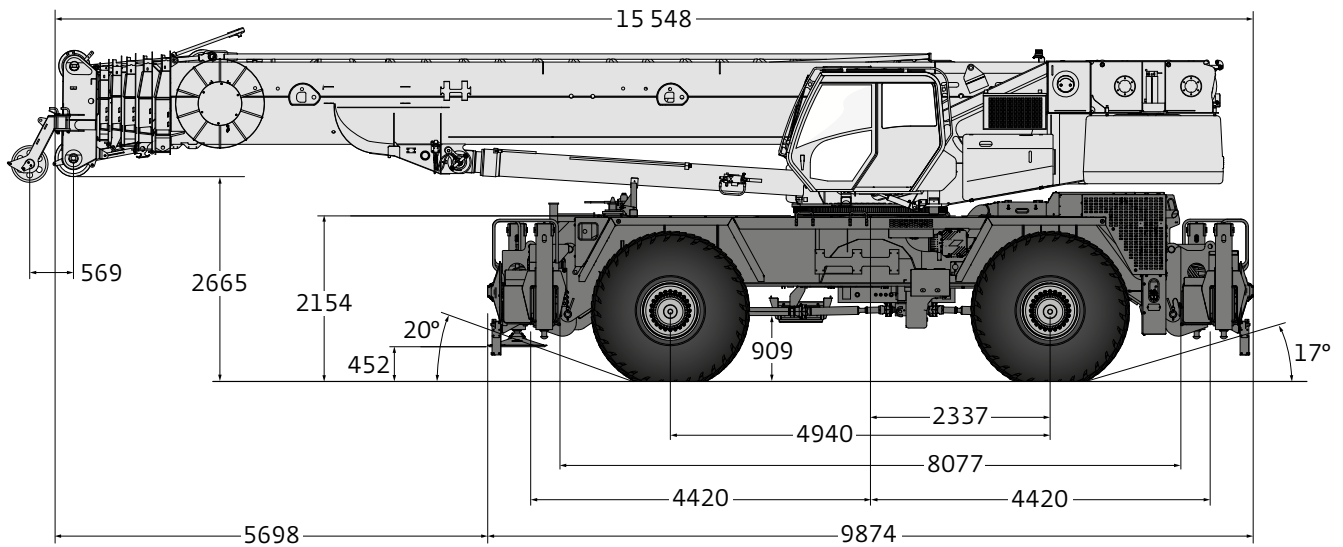

Tire size	A	B	C	D	E	F	G	A	B	C	D	E	F	G
33,25x29	17,9	18,5	15,7	14,9	14,4	11,7	10,2	13,6	14,2	11,0	10,1	9,7	6,9	5,9
	2 wheel steer							4 wheel steer						

Note: Reference dimensions in m • Hinweis: Bezugsmaße in m • Remarque: cotes de référence en m • Nota: Dimensiones de referencia en m • Nota: Dimensioni di riferimento in m • Nota: Dimensões de referência em m • Примечание: Справочные размеры (в м)



Axle Achse Essieu Eje Asse Eixo Оси	Front Vorne Avant Delantero Anteriore Dianteiro Передняя	Rear Hinten Arrière Trasero Posteriore Traseiro Задняя	Total weight Gesamtgewicht Poids total Peso total Peso totale Peso total Суммарный вес
	kg	kg	kg
<ul style="list-style-type: none"> Basic machine including 60,0 m main boom, main hoist with 255 m of rope, auxiliary hoist with 225 m of wire rope, 28577 kg counterweight, 11-18 m manual extension, 9 t headache ball, and 90 t hook block Basismaschine mit 60,0 m Hauptausleger, Hauptwinde mit 255 m Drahtseil, Hilfswinde mit 225 m Drahtseil, 28577 kg Gegengewicht, 11-18 m manuelle Verlängerung, 9 t Kugelhaken und 90 t Hakenflasche Machine de base comportant une flèche principale de 60,0 m, un treuil principal avec 255 m de câble, un treuil auxiliaire avec 225 m de câble, un contrepoids de 28577 kg, une extension manuelle de 11 à 18 m, une boule de démolition de 9 t et un bloc de crochet de 90 t Máquina básica que incluye pluma principal de 60,0 m, cabrestante principal con 255 m de cable, cabrestante auxiliar con 225 m de cable metálico, contrapeso de 28577 kg, extensión manual de 11-18 m, gancho de bola de 9 t y gancho de 90 t Macchina base comprensiva di braccio principale da 60,0 m, argano principale con 255 m di fune metallica, argano ausiliario con 225 m di fune metallica, contrappeso da 28577 kg, falcone meccanico da 11-18 m, gancio a palla da 9 t e bozzello da 90 t Máquina base que inclui: lança de 60,0 m, guincho principal com 255 m de cabo, guincho auxiliar com 225 m de cabo, contrapeso de 28577 kg, extensão manual de 11-18 m, gancho de bola de 9 t e gancho de 90 t Базовая машина с 60-метровой главной стрелой, главным подъёмником с 255-метровым тросом, дополнительным подъёмником с 225-метровым стальным тросом, противовесом в 28577 кг, 11-18-метровым ручным удлинением, 9-тонной шаровой бабой и 90-тонным крюкоблоком 	31 239	56 549	87 788
<ul style="list-style-type: none"> Remove 28 577 kg counterweight • Entfernen: 28.577 kg Gegengewicht • Retirer : contrepoids de 28 577 kg Retirar contrapeso de 28.577 kg • Togliere contrappeso da 28.577 kg • Retirar o contrapeso de 28 577 kg Снятие противовеса в 28 577 кг 	7665	- 36 242	- 28 577
Total weight • Gesamtgewicht • Poids total • Peso total • Peso totale • Peso total • Суммарный вес	38 904	20 307	59 211
<ul style="list-style-type: none"> Remove 11-18 m manual extension • Entfernen: 11-18 m manuelle Verlängerung Retirer : extension manuelle de 11 à 18 m • Retirar extensión manual de 11-18 m Togliere prolunga manuale da 11-18 m • Retirar a extensão manual de 11-18 m Снятие 11-18-метрового ручного удлинения 	- 2327	749	-1577
Total weight • Gesamtgewicht • Poids total • Peso total • Peso totale • Peso total • Суммарный вес	36 577	21 056	57 634
<ul style="list-style-type: none"> Remove 90 t hookblock • Entfernen: 90 t Hakenflasche • Retirer : bloc de crochet de 90 t • Retirar gancho de 90 t Togliere bozzello da 90 t • Retirar o gancho de 90t • Снятие 90-тонного крюкоблока 	-1094	- 56	-1150
Total weight • Gesamtgewicht • Poids total • Peso total • Peso totale • Peso total • Суммарный вес	35 483	21 000	56 484
<ul style="list-style-type: none"> Remove 9,0 t headache ball • Entfernen: 9,0 t Kugelhaken • Retirer : boule de démolition de 9,0 t • Retirar gancho de bola de 9,0 t • Togliere gancio a palla da 9,0 t • Retirar o gancho de bola de 9,0t • Снятие 9-тонной шаровой бабы 	- 526	196	-330
Total weight • Gesamtgewicht • Poids total • Peso total • Peso totale • Peso total • Суммарный вес	34 957	21 196	56 154
<ul style="list-style-type: none"> Remove front and rear outrigger boxes and beams • Entfernen: Abstützträger vorne und hinten und Träger • Retirer : poutres de calage et leurs boîtiers avant et arrière • Retirar las cajas de estabilizadores delantero y trasero y las vigas • Togliere casse stabilizzatori anteriori e posteriori • Retirar as caixas dos estabilizadores dianteiros e traseiros e as vigas • Снятие задних и передних лап домкратов и балок опоры 	-4045	- 4507	- 8552
Total weight • Gesamtgewicht • Poids total • Peso total • Peso totale • Peso total • Суммарный вес	30 912	16 689	47 602
<ul style="list-style-type: none"> Remove (4) tire/wheel assemblies • Entfernen: (4) Reifen/Rad Baugruppen • Retirer : (4) ensembles pneus/roues Retirar las (4) unidades de neumático/rueda • Togliere (4) ruote complete Retirar os 4 conjuntos de pneu/roda • Снятие (4) шинных/колесных узлов 	- 2159	-2159	- 4318
Total weight • Gesamtgewicht • Poids total • Peso total • Peso totale • Peso total • Суммарный вес	28 753	14 530	43 284
<ul style="list-style-type: none"> Remove main boom assembly, auxiliary boom nose and extensions brackets • Entfernen: Hauptauslegerbaugruppe, Hilfsauslegerkopf und Auslegerarme • Retirer : ensemble de flèche principale, tête de flèche auxiliaire et supports d'extensions • Retirar el conjunto de pluma principal, punta de pluma auxiliar y soportes de extensión • Togliere braccio principale, testa braccio ausiliario e staffe supporto falcone • Retirar o conjunto da lança principal, cabeça da lança auxiliar e os suportes da extensão • Снятие блока главной стрелы, вспомогательного наконечника стрелы и кронштейнов удлинения 	-19 009	3668	-15 342
Total weight • Gesamtgewicht • Poids total • Peso total • Peso totale • Peso total • Суммарный вес	9774	18 198	27 942



Lifting Capacity Traglast Force de levage Capacidad de elevación Capacità di sollevamento Capacidade de elevação Грузоподъемность	Sheaves Rollen Poulies Poleas Carrucole Roldanas Шкивы	Parts of line Stränge Brins Ramales de cable Numero di funi Partes de cabo Кратность запасовки	Total weight Gesamtgewicht Poids total Peso total Peso totale Peso total Суммарный вес
118 t	8	2 to 16	1148 kg
90,7 t	7	2 to 14	1150 kg
9,1 t	H/B (swivel)	1	330 kg

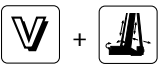

	Infinitely variable Stufenlos Progressivement variable Infinitamente variable Infinitamente variabile Infinitamente variável Плавно-изменяемый	Rope Seil Câble Cable Fune Cabo Канат	Permissible line pull max. Max. Seilzug Effort maxi au brin Tracciones del cable admisibles Tiro diretto massimo Esforço max. admissivel no cabo Максимально допустимое натяжение каната	Nominal cable length Seillänge (Nennwert) Longueur nominale des cables Longitud nominal del cable Lunghezza nominale cavo Comprimento nominal de cabo Номинальная длина каната
	0 - 135 m/min single line / bei einfachem Strang brin simple / ramal simple tiro a fune singola / cabo singelo Однократная запасовка	19 mm (35x7 WSC)	7167 kg	255 m
	0 - 135 m/min single line / bei einfachem Strang brin simple / ramal simple tiro a fune singola / cabo singelo Однократная запасовка	19 mm (35x7 WSC)	7167 kg	255 m
	0 - 1,5 min ⁻¹			
	20° 70° approx. 45 s ca. 45 s • env. 45 s aproximadamente 45 s circa 55 s • cerca de 45 s примерно 45 с			
	12,9 to 60,0 m approx. 430 s ca. 430 s • env. 430 s aproximadamente 430 s circa 430 s • cerca de 430 s примерно 430 с			

Load charts • Traglasten • Capacités de levage • Capacidades Caracità • Diagramas de carga • Таблицы грузоподъемности

Working range • Arbeitsbereiche • Diagramme de levage • Gama de trabajo • Area di lavoro
Intervalo de funcionamento • Грузовысотные характеристики



12,9 – 60,0 m



100 %



360°



28,6 t

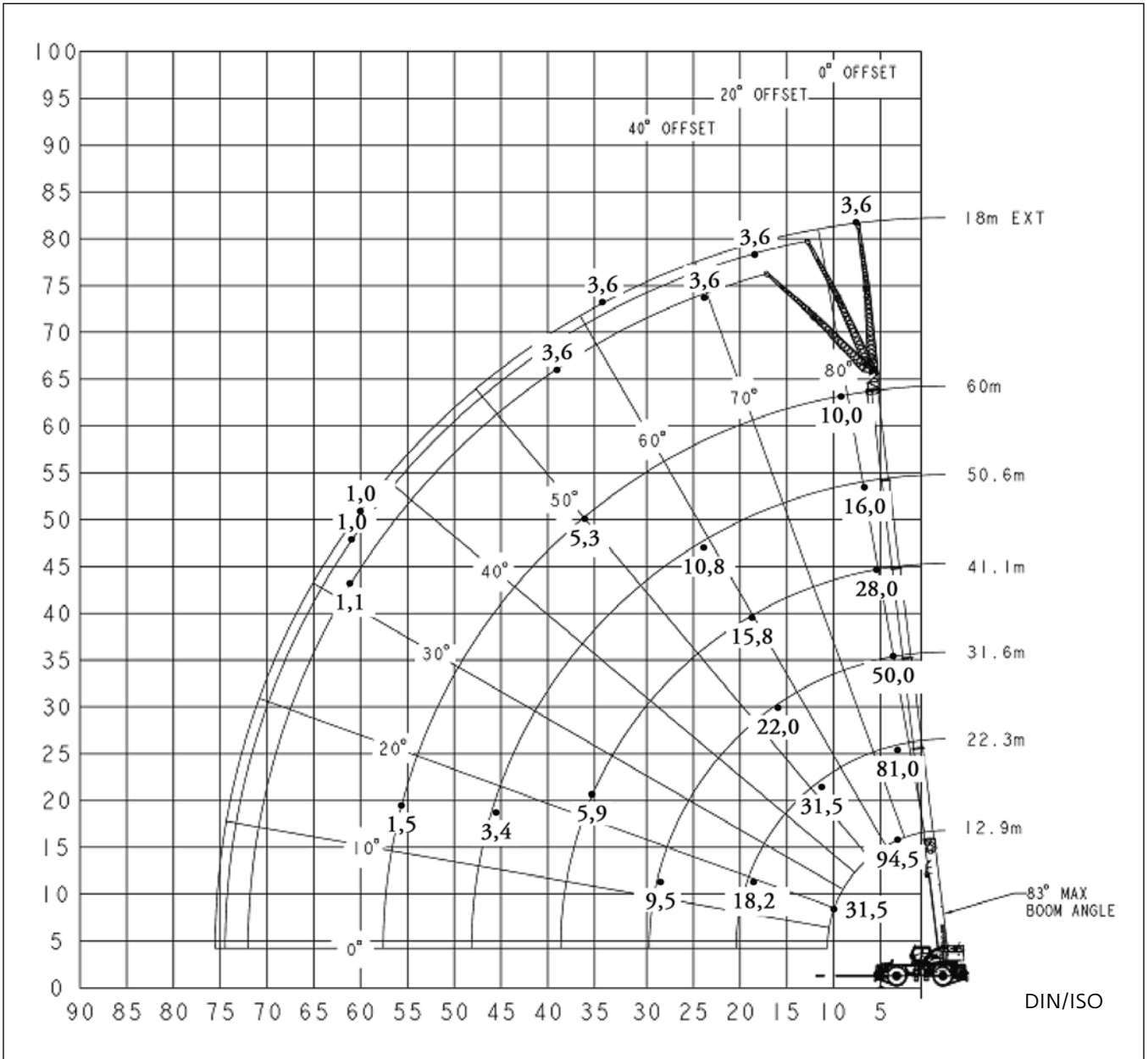

	H (mm)
	3110

Load charts • Traglasten • Capacités de levage • Capacidades Caracità • Diagramas de carga • Таблицы грузоподъемности

Telescopic boom • Teleskopausleger • Flèche principale • Pluma telescópica • Braccio telescopico
Lança telescópica • Телескопическая стрела



12,9 - 60,0 m



100 %



360°



28,6 t



EN13000

m	12,9	17,5	22,1	26,8	31,5	36,2	40,9	45,7	50,4	55,2	60,0	m
2,2	135,000*	-	-	-	-	-	-	-	-	-	-	2,2
3,0	94,500	86,000	81,000	65,000	-	-	-	-	-	-	-	3,0
4,0	81,000	76,500	71,000	65,000	50,000	-	-	-	-	-	-	4,0
5,0	70,500	67,500	63,000	60,500	49,500	38,000	-	-	-	-	-	5,0
6,0	62,000	60,000	57,500	54,500	47,000	37,000	28,000	20,500	-	-	-	6,0
7,0	55,000	53,000	52,000	50,000	44,000	35,000	28,000	20,500	16,000	-	-	7,0
8,0	48,000	47,500	47,000	46,000	41,500	33,000	28,000	20,500	16,000	11,600	-	8,0
9,0	41,000	43,000	42,500	41,500	39,000	31,500	26,500	20,500	16,000	11,600	10,000	9,0
10,0	31,500	38,375	38,500	37,500	37,000	29,500	25,000	20,500	16,000	11,600	10,000	10,0
12,0	-	31,500	31,500	31,000	32,000	26,500	22,500	19,500	16,000	11,600	10,000	12,0
14,0	-	25,000	26,575	26,000	26,975	23,500	19,700	17,700	15,800	11,600	10,000	14,0
16,0	-	-	21,500	22,500	22,000	21,500	17,600	15,900	14,500	11,600	10,000	16,0
18,0	-	-	18,200	18,600	18,100	18,900	15,800	14,400	13,000	11,600	10,000	18,0
20,0	-	-	-	15,700	16,100	15,900	13,900	12,700	11,900	11,100	9,700	20,0
22,0	-	-	-	13,400	14,200	13,600	12,600	11,500	10,800	10,300	9,100	22,0
24,0	-	-	-	9,600	12,300	11,800	11,600	10,400	9,800	9,400	8,600	24,0
26,0	-	-	-	-	10,800	10,200	10,800	9,500	8,900	8,600	8,000	26,0
28,0	-	-	-	-	9,500	9,300	9,500	8,400	8,200	7,900	7,600	28,0
30,0	-	-	-	-	-	8,700	8,400	7,500	7,500	7,300	7,100	30,0
32,0	-	-	-	-	-	8,000	7,500	6,900	6,500	6,500	6,400	32,0
34,0	-	-	-	-	-	-	6,600	6,200	5,700	5,700	5,700	34,0
36,0	-	-	-	-	-	-	5,900	5,900	5,000	5,300	5,300	36,0
38,0	-	-	-	-	-	-	-	5,500	4,500	5,000	4,900	38,0
40,0	-	-	-	-	-	-	-	5,000	4,200	4,700	4,500	40,0
42,0	-	-	-	-	-	-	-	4,500	3,900	4,400	3,900	42,0
44,0	-	-	-	-	-	-	-	-	3,600	3,900	3,500	44,0
46,0	-	-	-	-	-	-	-	-	3,400	3,500	3,100	46,0
48,0	-	-	-	-	-	-	-	-	-	3,100	2,700	48,0
50,0	-	-	-	-	-	-	-	-	-	2,700	2,300	50,0
52,0	-	-	-	-	-	-	-	-	-	-	2,000	52,0
54,0	-	-	-	-	-	-	-	-	-	-	1,700	54,0
56,0	-	-	-	-	-	-	-	-	-	-	1,490	56,0







85 %

m	12,9	17,5	22,1	26,8	31,5	36,2	40,9	45,7	50,4	55,2	60,0	m
2,2	135,000*	-	-	-	-	-	-	-	-	-	-	2,2
3,0	99,000	90,500	85,000	65,000	-	-	-	-	-	-	-	3,0
4,0	85,000	80,500	74,500	65,000	50,000	-	-	-	-	-	-	4,0
5,0	74,000	71,000	66,500	63,500	50,000	38,000	-	-	-	-	-	5,0
6,0	65,000	63,000	60,500	57,500	49,000	38,000	28,000	20,500	-	-	-	6,0
7,0	57,500	55,500	54,500	52,500	46,500	36,500	28,000	20,500	16,000	-	-	7,0
8,0	50,250	49,825	49,500	48,000	43,500	34,500	28,000	20,500	16,000	11,600	-	8,0
9,0	43,000	44,500	44,000	43,500	41,000	33,000	28,000	20,500	16,000	11,600	10,000	9,0
10,0	33,000	39,550	39,750	39,450	38,500	31,000	26,500	20,500	16,000	11,600	10,000	10,0
12,0	-	31,875	32,075	31,775	32,475	27,500	23,500	20,500	16,000	11,600	10,000	12,0
14,0	-	26,000	26,575	27,325	26,975	25,000	20,500	18,500	16,000	11,600	10,000	14,0
16,0	-	-	22,375	23,200	22,825	22,500	18,500	16,700	15,300	11,600	10,000	16,0
18,0	-	-	19,100	19,925	19,300	19,700	16,600	15,100	13,700	11,600	10,000	18,0
20,0	-	-	-	17,200	16,900	17,000	14,600	13,300	12,500	11,600	10,000	20,0
22,0	-	-	-	14,700	15,500	14,900	13,200	12,000	11,300	10,800	9,600	22,0
24,0	-	-	-	10,100	13,500	12,900	12,100	10,900	10,300	9,900	9,000	24,0
26,0	-	-	-	-	11,900	11,200	11,400	10,000	9,400	9,100	8,400	26,0
28,0	-	-	-	-	10,300	9,800	10,500	9,200	8,600	8,300	8,000	28,0
30,0	-	-	-	-	-	9,200	9,300	8,100	7,900	7,600	7,500	30,0
32,0	-	-	-	-	-	8,700	8,200	7,200	7,000	6,800	6,700	32,0
34,0	-	-	-	-	-	-	7,300	6,500	6,200	6,000	6,000	34,0
36,0	-	-	-	-	-	-	6,500	6,200	5,500	5,600	5,600	36,0
38,0	-	-	-	-	-	-	-	5,900	4,800	5,200	5,200	38,0
40,0	-	-	-	-	-	-	-	5,500	4,400	4,900	4,800	40,0
42,0	-	-	-	-	-	-	-	4,900	4,100	4,600	4,300	42,0
44,0	-	-	-	-	-	-	-	-	3,800	4,300	3,800	44,0
46,0	-	-	-	-	-	-	-	-	3,600	3,800	3,400	46,0
48,0	-	-	-	-	-	-	-	-	-	3,400	2,900	48,0
50,0	-	-	-	-	-	-	-	-	-	3,000	2,600	50,0
52,0	-	-	-	-	-	-	-	-	-	-	2,200	52,0
54,0	-	-	-	-	-	-	-	-	-	-	1,900	54,0
56,0	-	-	-	-	-	-	-	-	-	-	1,600	56,0

* With special equipment • Mit Sonderausrüstung • Avec équipement spécial • Con equipamiento especial • Con equipaggiamento speciale • Com equipamento especial • Со специальным оборудованием





Load charts • Traglasten • Capacités de levage • Capacidades Capacità • Diagramas de carga • Таблицы грузоподъемности

Telescopic boom • Teleskopausleger • Flèche principale • Pluma telescópica • Braccio telescopico
Lança telescópica • Телескопическая стрела

 12,9 - 60,0 m  50%  360°  28,6 t

  EN13000 - 85%

m	12,9	17,5	22,1	26,8	31,5	36,2	40,9	45,7	50,4	55,2	60,0	m
3,0	94,500	86,000	81,000	65,000	-	-	-	-	-	-	-	3,0
4,0	81,000	76,500	71,000	65,000	50,000	-	-	-	-	-	-	4,0
5,0	70,500	67,500	63,500	60,500	49,500	38,000	-	-	-	-	-	5,0
6,0	62,000	60,000	57,500	54,500	47,000	37,000	28,000	20,500	-	-	-	6,0
7,0	55,000	53,000	52,000	48,975	44,000	35,000	28,000	20,500	16,000	-	-	7,0
8,0	47,575	47,000	44,600	41,125	39,850	33,000	28,000	20,500	16,000	11,600	-	8,0
9,0	38,450	39,400	38,050	36,500	34,350	31,500	26,500	20,500	16,000	11,600	10,000	9,0
10,0	31,500	33,550	32,950	32,300	30,025	29,500	25,000	20,500	16,000	11,600	10,000	10,0
12,0	-	24,775	25,350	25,125	24,500	23,625	21,950	19,500	16,000	11,600	10,000	12,0
14,0	-	19,625	19,800	19,650	20,400	19,300	17,900	17,200	15,800	11,600	10,000	14,0
16,0	-	-	16,600	16,825	16,550	15,975	16,000	14,300	14,050	11,600	10,000	16,0
18,0	-	-	13,750	13,975	13,775	13,300	13,725	12,000	11,850	11,600	10,000	18,0
20,0	-	-	-	11,775	11,600	12,100	11,575	10,700	10,075	10,125	9,700	20,0
22,0	-	-	-	10,025	9,860	10,400	9,885	9,900	8,610	8,900	8,920	22,0
24,0	-	-	-	6,445	8,455	8,990	8,505	8,735	7,800	8,300	7,745	24,0
26,0	-	-	-	-	7,275	7,820	7,355	7,595	7,300	7,435	6,740	26,0
28,0	-	-	-	-	6,265	6,870	6,360	6,665	6,600	6,545	5,875	28,0
30,0	-	-	-	-	-	5,980	5,470	5,770	5,900	5,680	5,120	30,0
32,0	-	-	-	-	-	5,215	4,705	5,100	5,205	4,930	4,455	32,0
34,0	-	-	-	-	-	-	4,200	4,700	4,535	4,260	3,835	34,0
36,0	-	-	-	-	-	-	3,900	4,250	3,945	3,675	3,255	36,0
38,0	-	-	-	-	-	-	-	3,730	3,425	3,155	2,740	38,0
40,0	-	-	-	-	-	-	-	3,265	2,960	2,690	2,275	40,0
42,0	-	-	-	-	-	-	-	2,855	2,545	2,275	1,865	42,0
44,0	-	-	-	-	-	-	-	-	2,175	1,900	1,490	44,0
46,0	-	-	-	-	-	-	-	-	1,840	1,565	1,115	46,0
48,0	-	-	-	-	-	-	-	-	-	1,260	0,845	48,0
50,0	-	-	-	-	-	-	-	-	-	0,980	0,565	50,0

 12,9 - 60,0 m  0%  360°  28,6 t

  EN13000 - 85%

m	12,9	17,5	22,1	26,8	31,5	36,2	40,9	45,7	50,4	55,2	60,0	m
4,0	-	-	54,000	65,000	50,000	-	-	-	-	-	-	4,0
5,0	51,150	47,425	43,475	39,400	37,600	-	-	-	-	-	-	5,0
6,0	40,150	38,650	36,500	33,850	30,975	30,150	27,650	20,500	-	-	-	6,0
7,0	31,800	32,450	31,000	29,850	27,850	25,625	25,000	20,500	16,000	-	-	7,0
8,0	25,575	27,375	26,900	25,650	24,000	23,500	21,775	19,275	16,000	11,600	-	8,0
9,0	21,075	22,900	23,250	22,350	20,950	20,725	19,125	17,700	16,000	11,600	10,000	9,0
10,0	17,625	19,450	20,325	19,650	18,450	18,375	16,925	16,600	14,400	11,600	10,000	10,0
12,0	-	14,525	15,400	15,500	14,650	14,750	13,550	13,375	13,100	11,300	10,000	12,0
14,0	-	11,250	12,150	12,850	11,800	12,100	11,100	11,575	10,800	10,100	9,260	14,0
16,0	-	-	9,750	10,425	9,800	10,625	9,900	9,7105	9,020	8,395	7,615	16,0
18,0	-	-	7,945	8,620	8,765	8,930	8,560	8,195	7,585	7,010	6,285	18,0
20,0	-	-	-	7,200	7,335	7,500	7,270	6,945	6,395	5,880	5,195	20,0
22,0	-	-	-	6,045	6,210	6,395	6,205	5,910	5,390	4,920	4,280	22,0
24,0	-	-	-	2,285	5,210	5,400	5,265	5,035	4,540	4,095	3,490	24,0
26,0	-	-	-	-	4,380	4,560	4,425	4,290	3,815	3,385	2,800	26,0
28,0	-	-	-	-	3,680	3,855	3,720	3,630	3,185	2,775	2,205	28,0
30,0	-	-	-	-	-	3,250	3,115	3,025	2,640	2,235	1,680	30,0
32,0	-	-	-	-	-	2,730	2,590	2,495	2,155	1,760	1,215	32,0
34,0	-	-	-	-	-	-	2,130	2,040	1,725	1,340	0,805	34,0
36,0	-	-	-	-	-	-	1,730	1,635	1,340	0,965	-	36,0
38,0	-	-	-	-	-	-	-	1,275	0,980	0,625	-	38,0
40,0	-	-	-	-	-	-	-	0,955	0,660	-	-	40,0
42,0	-	-	-	-	-	-	-	0,675	-	-	-	42,0

Load charts • Traglasten • Capacités de levage • Capacidades Capacità • Diagramas de carga • Таблицы грузоподъемности

Telescopic boom • Teleskopausleger • Flèche principale • Pluma telescópica • Braccio telescopico
Lança telescópica • Телескопическая стрела



12,9 - 26,8 m



4 km/h



0°



28,6 t



EN13000 - 85%





m	12,8	17,5	22,1	26,8	m
5,0	26,000	-	-	-	5,0
6,0	20,400	-	-	-	6,0
7,0	20,400	15,400	-	-	7,0
8,0	18,350	15,400	-	-	8,0
9,0	15,575	15,400	15,400	-	9,0
10,0	13,225	15,400	15,400	-	10,0
12,0	-	12,325	13,375	11,700	12,0
14,0	-	9,790	10,800	11,650	14,0
16,0	-	-	8,775	9,740	16,0
18,0	-	-	7,150	8,180	18,0
20,0	-	-	-	6,895	20,0
22,0	-	-	-	5,825	22,0
24,0	-	-	-	4,915	24,0

80032300

Boom centered over front • Ausleger auf Vorder-zentrierten • Flèche centrée sur l'avant • Pluma centrada sobre el frente • Braccio centrato sul frontale • Lança centrada sobre a frente • Стрела по центру передней

Load charts • Traglasten • Capacités de levage • Capacidades Capacità • Diagramas de carga • Таблицы грузоподъемности

Telescopic boom • Teleskopausleger • Flèche principale • Pluma telescópica • Braccio telescopico
Lança telescópica • Телескопическая стрела

 12,9 - 60,0 m  100 %  360°  17,7 t

  EN13000





m	12,9	17,5	22,1	26,8	31,5	36,2	40,9	45,7	50,4	55,2	60,0	m
2,2	116,00	-	-	-	-	-	-	-	-	-	-	2,2
3,0	94,500	86,000	81,000	65,000	-	-	-	-	-	-	-	3,0
4,0	81,000	76,500	71,000	65,000	50,000	-	-	-	-	-	-	4,0
5,0	70,500	67,500	63,500	60,500	49,500	38,000	-	-	-	-	-	5,0
6,0	62,000	60,000	57,500	54,500	47,000	37,000	28,000	20,500	-	-	-	6,0
7,0	53,975	53,000	52,000	50,000	44,000	35,000	28,000	20,500	16,000	-	-	7,0
8,0	46,375	47,000	47,000	46,000	41,500	33,000	28,000	20,500	16,000	11,600	-	8,0
9,0	40,325	41,225	41,425	41,125	39,000	31,500	26,500	20,500	16,000	11,600	10,000	9,0
10,0	31,500	36,450	36,650	36,325	36,825	29,500	25,000	20,500	16,000	11,600	10,000	10,0
12,0	-	29,625	29,350	29,500	28,325	26,500	22,500	19,500	16,000	11,600	10,000	12,0
14,0	-	23,025	22,525	23,350	22,600	22,700	19,700	17,700	15,800	11,600	10,000	14,0
16,0	-	-	18,725	18,525	19,325	18,700	17,325	15,900	14,500	11,600	10,000	16,0
18,0	-	-	15,225	15,400	15,850	15,250	14,700	13,950	13,000	11,600	10,000	18,0
20,0	-	-	-	13,575	13,275	12,725	13,250	11,800	11,650	11,100	9,700	20,0
22,0	-	-	-	11,500	11,272	11,300	11,250	10,050	9,965	10,050	9,100	22,0
24,0	-	-	-	7,620	9,690	10,175	9,650	9,200	8,555	8,680	8,600	24,0
26,0	-	-	-	-	8,350	8,880	8,345	8,580	7,350	7,700	7,765	26,0
28,0	-	-	-	-	7,220	7,785	7,260	7,490	6,600	7,000	6,790	28,0
30,0	-	-	-	-	-	6,865	6,335	6,615	5,900	6,400	5,945	30,0
32,0	-	-	-	-	-	6,000	5,470	5,775	5,600	5,635	5,170	32,0
34,0	-	-	-	-	-	-	4,730	5,035	5,200	4,910	4,445	34,0
36,0	-	-	-	-	-	-	4,080	4,400	4,585	4,275	3,815	36,0
38,0	-	-	-	-	-	-	-	4,100	4,005	3,715	3,260	38,0
40,0	-	-	-	-	-	-	-	3,810	3,495	3,215	2,770	40,0
42,0	-	-	-	-	-	-	-	3,355	3,035	2,760	2,325	42,0
44,0	-	-	-	-	-	-	-	-	2,630	2,350	1,925	44,0
46,0	-	-	-	-	-	-	-	-	2,265	1,980	1,560	46,0
48,0	-	-	-	-	-	-	-	-	-	1,650	1,225	48,0
50,0	-	-	-	-	-	-	-	-	-	1,345	0,920	50,0
52,0	-	-	-	-	-	-	-	-	-	-	0,645	52,0



  85 %

m	12,9	17,5	22,1	26,8	31,5	36,2	40,9	45,7	50,4	55,2	60,0	m
2,2	120,000	-	-	-	-	-	-	-	-	-	-	2,2
3,0	99,000	90,500	85,000	65,000	-	-	-	-	-	-	-	3,0
4,0	85,000	80,500	74,500	65,000	50,000	-	-	-	-	-	-	4,0
5,0	74,000	71,000	66,500	63,500	50,000	38,000	-	-	-	-	-	5,0
6,0	64,100	63,000	60,500	57,500	49,000	38,000	28,000	20,500	-	-	-	6,0
7,0	53,975	54,800	54,500	52,500	46,500	36,500	28,000	20,500	16,000	-	-	7,0
8,0	46,375	47,175	47,375	47,050	43,500	34,500	28,000	20,500	16,000	11,600	-	8,0
9,0	40,325	41,225	41,425	41,125	41,000	33,000	28,000	20,500	16,000	11,600	10,000	9,0
10,0	33,000	36,500	36,650	36,325	37,050	31,000	26,500	20,500	16,000	11,600	10,000	10,0
12,0	-	29,625	29,350	30,250	29,825	27,500	23,500	20,500	16,000	11,600	10,000	12,0
14,0	-	24,325	24,050	24,975	24,525	25,000	20,500	18,500	16,000	11,600	10,000	14,0
16,0	-	-	21,000	21,000	20,500	21,175	18,500	16,700	15,300	11,600	10,000	16,0
18,0	-	-	17,250	17,100	17,950	17,275	16,575	15,100	13,700	11,600	10,000	18,0
20,0	-	-	-	14,400	15,025	14,350	14,000	13,300	12,500	11,600	10,000	20,0
22,0	-	-	-	13,050	12,775	12,150	12,750	11,450	11,300	10,800	9,600	22,0
24,0	-	-	-	8,800	10,975	11,100	10,925	9,670	9,845	9,900	9,000	24,0
26,0	-	-	-	-	9,465	10,050	9,460	9,000	8,385	8,695	8,400	26,0
28,0	-	-	-	-	8,215	8,825	8,230	8,400	7,175	7,475	7,855	28,0
30,0	-	-	-	-	-	7,755	7,195	7,450	6,215	6,700	6,905	30,0
32,0	-	-	-	-	-	6,870	6,345	6,615	5,800	6,300	6,015	32,0
34,0	-	-	-	-	-	-	5,555	5,840	5,500	5,700	5,250	34,0
36,0	-	-	-	-	-	-	4,870	5,165	5,100	5,030	4,580	36,0
38,0	-	-	-	-	-	-	-	4,550	4,700	4,435	3,990	38,0
40,0	-	-	-	-	-	-	-	4,100	4,205	3,910	3,465	40,0
42,0	-	-	-	-	-	-	-	3,900	3,720	3,440	3,000	42,0
44,0	-	-	-	-	-	-	-	-	3,285	3,010	2,580	44,0
46,0	-	-	-	-	-	-	-	-	2,895	2,620	2,200	46,0
48,0	-	-	-	-	-	-	-	-	-	2,265	1,850	48,0
50,0	-	-	-	-	-	-	-	-	-	1,945	1,530	50,0
52,0	-	-	-	-	-	-	-	-	-	-	1,235	52,0
54,0	-	-	-	-	-	-	-	-	-	-	0,965	54,0
56,0	-	-	-	-	-	-	-	-	-	-	0,725	56,0

Load charts • Traglasten • Capacités de levage • Capacidades Caracità • Diagramas de carga • Таблицы грузоподъемности

Telescopic boom • Teleskopausleger • Flèche principale • Pluma telescópica • Braccio telescopico
Lança telescópica • Телескопическая стрела

 12,9 - 60,0 m
  50%
  360°
  17,7 t



EN13000 - 85%

m	12,9	17,5	22,1	26,8	31,5	36,2	40,9	45,7	50,4	55,2	60,0	m
3,0	94,500	86,000	81,000	65,000	-	-	-	-	-	-	-	3,0
4,0	81,000	76,500	71,000	65,000	50,000	-	-	-	-	-	-	4,0
5,0	70,500	67,500	63,500	58,900	49,500	38,000	-	-	-	-	-	5,0
6,0	61,250	55,900	50,975	46,025	43,825	37,000	28,000	20,500	-	-	-	6,0
7,0	47,600	45,000	41,050	39,400	36,025	34,975	28,000	20,500	16,000	-	-	7,0
8,0	36,675	37,450	34,500	33,025	32,000	29,725	27,300	20,500	16,000	11,600	-	8,0
9,0	29,375	30,975	30,150	28,200	27,825	25,625	23,575	20,500	16,000	11,600	10,000	9,0
10,0	24,150	26,300	26,050	25,000	24,275	22,400	21,500	19,600	16,000	11,600	10,000	10,0
12,0	-	19,200	20,125	20,225	19,075	18,200	17,575	15,500	14,975	11,600	10,000	12,0
14,0	-	14,675	15,600	15,750	15,425	15,525	14,275	13,800	12,025	11,600	10,000	14,0
16,0	-	-	12,450	12,675	12,400	12,925	11,800	11,725	11,000	10,850	9,980	16,0
18,0	-	-	10,200	10,400	10,125	10,650	9,875	9,880	9,790	9,140	8,330	18,0
20,0	-	-	-	9,135	8,395	9,000	8,330	8,700	8,340	7,740	6,985	20,0
22,0	-	-	-	7,725	7,300	8,030	7,300	7,715	7,140	6,585	5,870	22,0
24,0	-	-	-	3,675	6,300	6,920	6,200	6,655	6,135	5,610	4,930	24,0
26,0	-	-	-	-	5,750	5,940	5,700	5,705	5,285	4,785	4,130	26,0
28,0	-	-	-	-	4,905	5,090	4,950	4,855	4,535	4,070	3,435	28,0
30,0	-	-	-	-	-	4,365	4,225	4,130	3,820	3,445	2,830	30,0
32,0	-	-	-	-	-	3,745	3,600	3,505	3,200	2,885	2,300	32,0
34,0	-	-	-	-	-	-	3,060	2,906	2,660	2,385	1,815	34,0
36,0	-	-	-	-	-	-	2,585	2,485	2,185	1,910	1,380	36,0
38,0	-	-	-	-	-	-	-	2,065	1,765	1,495	0,990	38,0
40,0	-	-	-	-	-	-	-	1,695	1,390	1,120	0,640	40,0
42,0	-	-	-	-	-	-	-	1,365	1,055	0,785	-	42,0
44,0	-	-	-	-	-	-	-	-	0,755	-	-	44,0

 12,9 - 60,0 m
  0%
  360°
  17,7 t









EN13000 - 85%

m	12,9	17,5	22,1	26,8	31,5	36,2	40,9	45,7	50,4	55,2	60,0	m
3,0	76,050	65,900	57,525	52,000	-	-	-	-	-	-	-	3,0
4,0	51,325	47,300	43,200	40,775	36,975	-	-	-	-	-	-	4,0
5,0	37,700	36,625	34,650	32,200	29,500	28,350	-	-	-	-	-	5,0
6,0	29,150	29,075	28,025	26,300	24,250	23,575	21,450	19,000	-	-	-	6,0
7,0	23,300	23,725	23,275	22,000	20,350	19,975	18,200	17,625	15,050	-	-	7,0
8,0	18,450	19,750	19,750	19,550	17,350	17,925	16,800	15,900	13,500	11,600	-	8,0
9,0	14,925	16,700	16,900	16,950	15,800	15,650	14,725	13,925	12,925	11,000	10,000	9,0
10,0	12,225	14,075	14,600	14,800	14,275	13,800	13,000	12,300	11,400	10,550	9,580	10,0
12,0	-	10,200	11,150	11,550	11,250	10,975	10,325	9,780	9,010	8,300	7,440	12,0
14,0	-	7,550	8,520	9,195	9,000	8,870	8,350	7,890	7,210	6,585	5,810	14,0
16,0	-	-	6,590	7,320	7,290	7,225	6,800	6,430	5,810	5,245	4,530	16,0
18,0	-	-	5,070	5,860	5,950	4,880	5,555	5,245	4,690	4,170	3,495	18,0
20,0	-	-	-	4,660	4,830	4,880	4,540	4,265	3,760	3,290	2,645	20,0
22,0	-	-	-	3,705	3,865	4,020	3,700	3,450	2,970	2,535	1,930	22,0
24,0	-	-	-	-	3,080	3,265	2,995	2,765	2,305	1,890	1,315	24,0
26,0	-	-	-	-	2,425	2,605	2,395	2,175	1,735	1,335	0,775	26,0
28,0	-	-	-	-	1,870	2,050	1,880	1,670	1,240	0,850	-	28,0
30,0	-	-	-	-	-	1,570	1,435	1,230	0,810	-	-	30,0
32,0	-	-	-	-	-	1,160	1,020	0,845	-	-	-	32,0
34,0	-	-	-	-	-	-	0,660	0,500	-	-	-	34,0

Load charts • Traglasten • Capacités de levage • Capacidades Capacità • Diagramas de carga • Таблицы грузоподъемности

Telescopic boom • Teleskopausleger • Flèche principale • Pluma telescópica • Braccio telescopico
Lança telescópica • Телескопическая стрела

 12,9 - 26,8 m	 4 km/h	 0°	 17,7 t
			EN13000 - 85%

m	12,9	17,5	22,1	26,8	m
5,0	23,875	-	-	-	5,0
6,0	19,600	15,400	-	-	6,0
7,0	16,100	15,400	-	-	7,0
8,0	13,275	15,250	-	-	8,0
9,0	10,925	13,225	14,175	-	9,0
10,0	8,975	11,475	12,450	-	10,0
12,0	-	8,685	9,740	10,375	12,0
14,0	-	6,575	7,590	8,440	14,0
16,0	-	-	5,915	6,870	16,0
18,0	-	-	4,565	5,590	18,0
20,0	-	-	-	4,540	20,0
22,0	-	-	-	3,660	22,0
24,0	-	-	-	2,915	24,0

Boom centered over front • Ausleger 0° nach vorne • Flèche centrée sur l'avant • Pluma centrada sobre el frente • Braccio principale fronte marcia • Lança centrada sobre a frente • Стрела по центру передней

 12,9 - 60,0 m	 100 %	 360°	 0 t
			EN13000

m	12,9	17,5	m
3,0	45,000	45,000	3,0
4,0	45,000	45,000	4,0
5,0	45,000	45,000	5,0
6,0	45,000	45,000	6,0
7,0	45,000	45,000	7,0
8,0	38,850	37,250	8,0
9,0	29,325	30,275	9,0
10,0	23,000	25,300	10,0
12,0	-	17,500	12,0

		85 %
---	---	------

m	12,9	17,5	m
3,0	45,000	45,000	3,0
4,0	45,000	45,000	4,0
5,0	45,000	45,000	5,0
6,0	45,000	45,000	6,0
7,0	45,000	45,000	7,0
8,0	39,000	40,525	8,0
9,0	33,250	35,075	9,0
10,0	26,075	28,000	10,0
12,0	-	19,850	12,0

 12,9 - 60,0 m	 0 km	 360°	 0 kg
			EN13000

m	12,9	17,5	m
3,0	11,000	11,000	3,0
4,0	11,000	11,000	4,0
5,0	8,880	9,975	5,0
6,0	5,845	7,205	6,0
7,0	3,705	5,200	7,0

		85 %
---	---	------

m	12,9	17,5	m
3,0	11,000	11,000	3,0
4,0	11,000	11,000	4,0
5,0	11,000	11,000	5,0
6,0	7,400	9,105	6,0
7,0	4,810	6,540	7,0
8,0	-	4,700	8,0

Load charts • Traglasten • Capacités de levage • Capacidades Caracità • Diagramas de carga • Таблицы грузоподъемности

Manual bifold swingaway • Manuelle Doppelklappspitze • Extension à double repliage latéral manuel • Extensión abatible, manual, articulada en dos secciones • Falcone ripieghevole meccanico • Extensão dupla articulada, manual • Ручной двухсекционный вывод



12,9 - 60,0 m



11,0 - 18,0 m



100 %



360°



28,6 t



EN13000

m	11,00						18,00						m
	0°		20°		40°		0°		20°		40°		
	36,50	60,00	36,50	60,00	36,50	60,00	36,50	60,00	36,50	60,00	36,50	60,00	
5	14,200	-	-	-	-	-	-	-	-	-	-	-	5
6	14,200	-	-	-	-	-	-	-	-	-	-	-	6
7	14,200	-	-	-	-	-	6,600	-	-	-	-	-	7
8	14,200	-	-	-	-	-	6,500	-	-	-	-	-	8
9	14,200	-	12,100	-	-	-	6,400	-	-	-	-	-	9
10	14,200	5,300	11,900	-	-	-	6,400	-	-	-	-	-	10
11	13,800	5,300	11,700	-	9,200	-	6,300	-	-	-	-	-	11
12	13,500	5,300	11,500	-	9,100	-	6,200	3,600	-	-	-	-	12
13	13,300	5,300	11,200	-	8,900	-	6,200	3,600	5,500	-	-	-	13
14	13,100	5,300	10,900	5,300	8,800	-	6,100	3,600	5,400	-	-	-	14
15	12,800	5,300	10,600	5,300	8,700	-	6,100	3,600	5,300	-	-	-	15
16	12,600	5,300	10,300	5,300	8,500	5,300	6,000	3,600	5,300	-	-	-	16
18	12,200	5,300	9,800	5,300	8,200	5,300	5,900	3,600	5,100	3,600	4,500	-	18
20	11,400	5,300	9,300	5,300	8,000	5,300	5,700	3,600	5,000	3,600	4,400	-	20
22	10,700	5,300	8,900	5,300	7,800	5,300	5,600	3,600	4,900	3,600	4,300	-	22
24	10,000	5,300	8,500	5,300	7,600	5,300	5,500	3,600	4,800	3,600	4,200	3,600	24
26	9,400	5,300	8,200	5,300	7,400	5,300	5,300	3,600	4,600	3,600	4,100	3,600	26
28	8,900	5,300	7,900	5,200	7,100	5,300	5,200	3,600	4,500	3,600	4,100	3,600	28
30	8,400	5,000	7,600	5,000	6,800	5,000	5,000	3,600	4,400	3,600	4,000	3,600	30
32	7,400	4,800	7,200	4,700	6,700	4,700	4,900	3,600	4,300	3,600	3,900	3,600	32
34	6,600	4,500	6,800	4,400	6,600	4,500	4,800	3,600	4,200	3,600	3,900	3,600	34
36	5,900	4,200	6,100	4,200	6,100	4,200	4,600	3,600	4,100	3,600	3,900	3,600	36
38	5,200	4,000	5,400	4,000	5,400	4,000	4,500	3,500	4,000	3,500	3,800	3,600	38
40	4,600	3,700	4,800	3,700	-	3,800	4,400	3,300	4,000	3,300	3,800	3,500	40
42	4,100	3,600	4,200	3,500	-	3,600	4,200	3,200	3,900	3,200	3,800	3,300	42
44	-	3,200	-	3,400	-	3,400	4,100	3,000	3,800	3,000	3,800	3,100	44
46	-	2,800	-	3,000	-	3,200	3,700	2,800	3,800	2,800	-	3,000	46
48	-	2,400	-	2,600	-	2,700	3,400	2,700	3,500	2,700	-	2,800	48
50	-	2,100	-	2,300	-	2,300	3,000	2,400	3,100	2,600	-	2,700	50
52	-	1,800	-	1,900	-	2,000	-	2,100	-	2,400	-	2,500	52
54	-	1,500	-	1,600	-	1,700	-	1,800	-	2,100	-	2,300	54
56	-	1,200	-	1,300	-	1,300	-	1,500	-	1,800	-	2,000	56
58	-	0,900	-	1,100	-	-	-	1,300	-	1,500	-	1,600	58
60	-	-	-	-	-	-	-	1,000	-	1,300	-	1,400	60
62	-	-	-	-	-	-	-	-	-	1,000	-	1,100	62

Load charts • Traglasten • Capacités de levage • Capacidades Capacità • Diagramas de carga • Таблицы грузоподъемности

Manual bifold swingaway • Manuelle Doppelklappspitze • Extension à double repliage latéral manuel • Extensión abatible, manual, articulada en dos secciones • Falcone ripieghevole meccanico • Extensão dupla articulada, manual • Ручной двухсекционный вывод



12,9 - 60,0 m



11,0 - 18,0 m



100 %



360°



28,6 t



85 %

m	11,00						18,00						m
	0°		20°		40°		0°		20°		40°		
	36,50	60,00	36,50	60,00	36,50	60,00	36,50	60,00	36,50	60,00	36,50	60,00	
5	14,200	-	-	-	-	-	-	-	-	-	-	-	5
6	14,200	-	-	-	-	-	-	-	-	-	-	-	6
7	14,200	-	-	-	-	-	6,700	-	-	-	-	-	7
8	14,200	-	-	-	-	-	6,700	-	-	-	-	-	8
9	14,200	-	12,700	-	-	-	6,700	-	-	-	-	-	9
10	14,200	5,300	12,500	-	-	-	6,700	-	-	-	-	-	10
11	14,200	5,300	12,300	-	9,700	-	6,600	-	-	-	-	-	11
12	14,200	5,300	12,000	-	9,500	-	6,600	3,600	-	-	-	-	12
13	14,000	5,300	11,800	-	9,400	-	6,500	3,600	5,800	-	-	-	13
14	13,700	5,300	11,400	5,300	9,200	-	6,400	3,600	5,700	-	-	-	14
15	13,500	5,300	11,100	5,300	9,100	-	6,400	3,600	5,600	-	-	-	15
16	13,200	5,300	10,800	5,300	9,000	5,300	6,300	3,600	5,500	-	-	-	16
18	12,800	5,300	10,200	5,300	8,700	5,300	6,200	3,600	5,400	3,600	4,700	-	18
20	12,000	5,300	9,800	5,300	8,400	5,300	6,000	3,600	5,200	3,600	4,600	-	20
22	11,300	5,300	9,400	5,300	8,200	5,300	5,900	3,600	5,100	3,600	4,500	-	22
24	10,600	5,300	9,000	5,300	8,000	5,300	5,800	3,600	5,000	3,600	4,400	3,600	24
26	9,900	5,300	8,600	5,300	7,700	5,300	5,600	3,600	4,900	3,600	4,300	3,600	26
28	9,400	5,300	8,300	5,300	7,400	5,300	5,400	3,600	4,800	3,600	4,300	3,600	28
30	8,800	5,300	8,000	5,200	7,100	5,300	5,300	3,600	4,700	3,600	4,200	3,600	30
32	8,200	5,000	7,600	4,900	7,000	5,000	5,200	3,600	4,600	3,600	4,100	3,600	32
34	7,300	4,700	7,200	4,600	7,000	4,700	5,000	3,600	4,400	3,600	4,100	3,600	34
36	6,500	4,400	6,700	4,400	6,700	4,400	4,900	3,600	4,300	3,600	4,100	3,600	36
38	5,700	4,200	5,900	4,200	5,900	4,200	4,800	3,600	4,200	3,600	4,000	3,600	38
40	5,100	3,900	5,200	3,900	-	4,000	4,600	3,500	4,200	3,500	4,000	3,600	40
42	4,600	3,700	4,600	3,700	-	3,800	4,500	3,300	4,100	3,300	4,000	3,500	42
44	-	3,500	-	3,500	-	3,600	4,300	3,100	4,000	3,200	4,000	3,300	44
46	-	3,100	-	3,300	-	3,400	4,100	3,000	3,900	3,000	-	3,100	46
48	-	2,700	-	2,900	-	3,000	3,700	2,800	3,800	2,800	-	2,900	48
50	-	2,300	-	2,500	-	2,600	3,300	2,600	3,400	2,700	-	2,800	50
52	-	1,900	-	2,100	-	2,200	-	2,300	-	2,600	-	2,600	52
54	-	1,600	-	1,800	-	1,800	-	2,000	-	2,300	-	2,500	54
56	-	1,300	-	1,500	-	1,500	-	1,700	-	2,000	-	2,200	56
58	-	1,000	-	1,200	-	-	-	1,400	-	1,700	-	1,800	58
60	-	-	-	0,900	-	-	-	1,100	-	1,400	-	1,500	60
62	-	-	-	-	-	-	-	0,900	-	1,100	-	1,200	62
64	-	-	-	-	-	-	-	-	-	0,900	-	-	64

Load charts • Traglasten • Capacités de levage • Capacidades Caracità • Diagramas de carga • Таблицы грузоподъемности

Hydraulic bifold swingaway • Hydraulische Doppelklappspitze • Extension à double repliage latéral hydraulique • Abatible, hidráulica, articulada en dos secciones • Falcone ripieghevole idraulico • Extensão dupla articulada, hidráulica • Гидравлический двухсекционный вывод



12,9 - 60,0 m



11,0 - 18,0 m



100 %



360°



28,6 t



EN13000

m	11,00						18,00						m
	0° fixed		0° - 20°		20° - 40°		0° fixed		0° - 20°		20° - 40°		
	36,50	60,00	36,50	60,00	36,50	60,00	36,50	60,00	36,50	60,00	36,50	60,00	
7	14,200	-	-	-	-	-	6,600	-	-	-	-	-	7
8	14,200	-	-	-	-	-	6,500	-	-	-	-	-	8
9	14,200	-	12,100	-	-	-	6,400	-	-	-	-	-	9
10	14,200	5,300	11,900	-	-	-	6,400	-	-	-	-	-	10
11	13,800	5,300	11,700	-	9,200	-	6,300	-	-	-	-	-	11
12	13,500	5,300	11,500	-	9,100	-	6,200	3,600	-	-	-	-	12
13	13,300	5,300	11,200	-	8,900	-	6,200	3,600	5,500	-	-	-	13
14	13,100	5,300	10,900	5,300	8,800	-	6,100	3,600	5,400	-	-	-	14
15	12,800	5,300	10,600	5,300	8,700	-	6,100	3,600	5,300	-	-	-	15
16	12,600	5,300	10,300	5,300	8,500	5,300	6,000	3,600	5,300	-	-	-	16
18	12,200	5,300	9,800	5,300	8,200	5,300	5,900	3,600	5,100	3,600	4,500	-	18
20	11,400	5,300	9,300	5,300	8,000	5,300	5,700	3,600	5,000	3,600	4,400	-	20
22	10,700	5,300	8,900	5,300	7,800	5,300	5,600	3,600	4,900	3,600	4,300	-	22
24	10,000	5,300	8,500	5,300	7,600	5,300	5,500	3,600	4,800	3,600	4,200	3,600	24
26	9,400	5,300	8,200	5,300	7,400	5,300	5,300	3,600	4,600	3,600	4,100	3,600	26
28	8,900	5,300	7,900	5,200	7,100	5,200	5,200	3,600	4,500	3,600	4,100	3,600	28
30	8,400	5,000	7,600	5,000	6,800	5,000	5,000	3,600	4,400	3,600	4,000	3,600	30
32	7,400	4,800	7,200	4,700	6,700	4,700	4,900	3,600	4,300	3,600	3,900	3,600	32
34	6,600	4,500	6,600	4,400	6,600	4,400	4,800	3,600	4,200	3,600	3,900	3,600	34
36	5,900	4,200	5,900	4,200	6,100	4,200	4,600	3,600	4,100	3,600	3,900	3,600	36
38	5,200	4,000	5,200	4,000	5,400	4,000	4,500	3,500	4,000	3,500	3,800	3,500	38
40	4,600	3,700	4,600	3,700	-	3,700	4,400	3,300	4,000	3,300	3,800	3,300	40
42	4,100	3,600	4,100	3,500	-	3,500	4,200	3,200	3,900	3,200	3,800	3,200	42
44	-	3,200	-	3,200	-	3,400	4,100	3,000	3,800	3,000	3,800	3,000	44
46	-	2,800	-	2,800	-	3,000	3,700	2,800	3,700	2,800	-	2,800	46
48	-	2,400	-	2,400	-	2,600	3,400	2,700	3,400	2,700	-	2,700	48
50	-	2,100	-	2,100	-	2,300	3,000	2,400	3,000	2,400	-	2,600	50
52	-	1,800	-	1,800	-	1,900	-	2,100	-	2,100	-	2,400	52
54	-	1,500	-	1,500	-	1,600	-	1,800	-	1,800	-	2,100	54
56	-	1,200	-	1,200	-	1,300	-	1,500	-	1,500	-	1,800	56
58	-	0,900	-	0,900	-	-	-	1,300	-	1,300	-	1,500	58
60	-	-	-	-	-	-	-	1,000	-	1,000	-	1,300	60
62	-	-	-	-	-	-	-	-	-	-	-	1,000	62



85 %

m	11,00						18,00						m
	0° fixed		0° - 20°		20° - 40°		0° fixed		0° - 20°		20° - 40°		
	36,50	60,00	36,50	60,00	36,50	60,00	36,50	60,00	36,50	60,00	36,50	60,00	
5	14,200	-	-	-	-	-	-	-	-	-	-	-	5
6	14,200	-	-	-	-	-	-	-	-	-	-	-	6
7	14,200	-	-	-	-	-	6,700	-	-	-	-	-	7
8	14,200	-	-	-	-	-	6,700	-	-	-	-	-	8
9	14,200	-	12,700	-	-	-	6,700	-	-	-	-	-	9
10	14,200	5,300	12,500	-	-	-	6,700	-	-	-	-	-	10
11	14,200	5,300	12,300	-	9,700	-	6,600	-	-	-	-	-	11
12	14,200	5,300	12,000	-	9,500	-	6,600	3,600	-	-	-	-	12
13	14,000	5,300	11,800	-	9,400	-	6,500	3,600	5,800	-	-	-	13
14	13,700	5,300	11,400	5,300	9,200	-	6,400	3,600	5,700	-	-	-	14
15	13,500	5,300	11,100	5,300	9,100	-	6,400	3,600	5,600	-	-	-	15
16	13,200	5,300	10,800	5,300	9,000	5,300	6,300	3,600	5,500	-	-	-	16
18	12,800	5,300	10,200	5,300	8,700	5,300	6,200	3,600	5,400	3,600	4,700	-	18
20	12,000	5,300	9,800	5,300	8,400	5,300	6,000	3,600	5,200	3,600	4,600	-	20
22	11,300	5,300	9,400	5,300	8,200	5,300	5,900	3,600	5,100	3,600	4,500	-	22
24	10,600	5,300	9,000	5,300	8,000	5,300	5,800	3,600	5,000	3,600	4,400	3,600	24
26	9,900	5,300	8,600	5,300	7,700	5,300	5,600	3,600	4,900	3,600	4,300	3,600	26
28	9,400	5,300	8,300	5,300	7,400	5,300	5,400	3,600	4,800	3,600	4,300	3,600	28
30	8,800	5,300	8,000	5,200	7,100	5,200	5,300	3,600	4,700	3,600	4,200	3,600	30
32	8,200	5,000	7,600	4,900	7,000	4,900	5,200	3,600	4,600	3,600	4,100	3,600	32
34	7,300	4,700	7,200	4,600	7,000	4,600	5,000	3,600	4,400	3,600	4,100	3,600	34
36	6,500	4,400	6,500	4,400	6,700	4,400	4,900	3,600	4,300	3,600	4,100	3,600	36
38	5,700	4,200	5,700	4,200	5,900	4,200	4,800	3,600	4,200	3,600	4,000	3,600	38
40	5,100	3,900	5,100	3,900	-	3,900	4,600	3,500	4,200	3,500	4,000	3,500	40
42	4,600	3,700	4,600	3,700	-	3,700	4,500	3,300	4,100	3,300	4,000	3,300	42
44	-	3,500	-	3,500	-	3,500	4,300	3,100	4,000	3,100	4,000	3,200	44
46	-	3,100	-	3,100	-	3,300	4,100	3,000	3,900	3,000	-	3,000	46
48	-	2,700	-	2,700	-	2,900	3,700	2,800	3,700	2,800	-	2,800	48
50	-	2,300	-	2,300	-	2,500	3,300	2,600	3,300	2,600	-	2,700	50
52	-	1,900	-	1,900	-	2,100	-	2,300	-	2,300	-	2,600	52
54	-	1,600	-	1,600	-	1,800	-	2,000	-	2,000	-	2,300	54
56	-	1,300	-	1,300	-	1,500	-	1,700	-	1,700	-	2,000	56
58	-	1,000	-	1,000	-	-	-	1,400	-	1,400	-	1,700	58
60	-	-	-	-	-	-	-	1,100	-	1,100	-	1,400	60
62	-	-	-	-	-	-	-	0,900	-	0,900	-	1,100	62

Load charts • Traglasten • Capacités de levage • Capacidades Capacità • Diagramas de carga • Таблицы грузоподъемности

Manual bifold swingaway with inserts • Manuelle Doppelklappspitze mit Verlängerungen • Double repliage latéral manuel avec éléments intermédiaires • Abatible manual, articulada en dos secciones, con inserciones • Falcone ripieghevole meccanico con inserti • Extensão dupla articulada, manual, com inserções • Ручной двухсекционный вывод с вставками



12,9 - 60,0 m



26,0 - 32,0 m



100 %



360°



28,6 t



EN13000

m	26,00						32,00						m	
	8			40°			8 + 6			40°				
	0°	60,00	36,50	20°	60,00	36,50	0°	60,00	20°	60,00	36,50	40°		60,00
9	5,400	-	-	-	-	-	-	-	-	-	-	-	-	9
10	5,400	-	-	-	-	-	4,200	-	-	-	-	-	-	10
11	5,400	-	-	-	-	-	4,200	-	-	-	-	-	-	11
12	5,400	-	-	-	-	-	4,200	-	-	-	-	-	-	12
13	5,400	-	-	-	-	-	4,200	-	-	-	-	-	-	13
14	5,400	2,500	-	-	-	-	4,200	-	-	-	-	-	-	14
15	5,300	2,500	4,900	-	-	-	4,200	1,900	-	-	-	-	-	15
16	5,300	2,500	4,800	-	-	-	4,200	1,900	3,900	-	-	-	-	16
18	5,200	2,500	4,600	-	-	-	4,000	1,900	3,800	-	-	-	-	18
20	5,000	2,500	4,400	2,500	4,000	-	3,900	1,900	3,600	-	-	-	-	20
22	4,800	2,500	4,200	2,500	3,800	-	3,700	1,900	3,500	1,900	3,100	-	-	22
24	4,600	2,500	4,000	2,500	3,700	-	3,600	1,900	3,300	1,900	3,000	-	-	24
26	4,400	2,500	3,900	2,500	3,500	2,500	3,400	1,900	3,200	1,900	2,900	1,700	-	26
28	4,200	2,500	3,700	2,500	3,400	2,500	3,300	1,900	3,100	1,900	2,800	1,700	-	28
30	4,000	2,500	3,600	2,500	3,300	2,500	3,100	1,900	2,900	1,900	2,700	1,700	-	30
32	3,800	2,500	3,400	2,500	3,200	2,500	3,000	1,900	2,800	1,900	2,600	1,700	-	32
34	3,600	2,500	3,300	2,500	3,100	2,500	2,900	1,900	2,700	1,900	2,500	1,700	-	34
36	3,500	2,500	3,200	2,500	3,000	2,500	2,700	1,900	2,600	1,900	2,400	1,700	-	36
38	3,300	2,500	3,100	2,500	2,900	2,500	2,600	1,900	2,500	1,900	2,300	1,700	-	38
40	3,200	2,500	2,900	2,500	2,800	2,500	2,500	1,900	2,400	1,900	2,300	1,700	-	40
42	3,000	2,500	2,900	2,500	2,800	2,500	2,400	1,900	2,300	1,900	2,200	1,700	-	42
44	2,900	2,400	2,800	2,500	2,700	2,500	2,300	1,900	2,200	1,900	2,100	1,700	-	44
46	2,800	2,300	2,700	2,300	2,600	2,500	2,200	1,900	2,100	1,900	2,000	1,700	-	46
48	2,700	2,100	2,600	2,200	2,600	2,300	2,100	1,800	2,000	1,900	2,000	1,700	-	48
50	2,600	2,000	2,500	2,100	2,500	2,200	2,000	1,700	1,900	1,800	1,900	1,700	-	50
52	2,500	1,900	2,500	2,000	-	2,100	1,900	1,600	1,900	1,700	1,900	1,700	-	52
54	2,400	1,800	2,400	1,800	-	2,000	1,800	1,500	1,800	1,500	1,800	1,700	-	54
56	2,200	1,500	2,300	1,700	-	1,800	1,800	1,300	1,700	1,400	1,700	1,600	-	56
58	2,000	1,300	2,000	1,600	-	1,700	1,700	1,200	1,700	1,300	-	1,400	-	58
60	-	1,000	-	1,300	-	1,500	1,700	1,000	1,600	1,200	-	1,300	-	60
62	-	-	-	1,095	-	1,200	1,600	-	1,600	1,100	-	1,200	-	62
64	-	-	-	-	-	0,900	1,400	-	1,400	-	-	1,000	-	64



85 %

m	26,00						32,00						m	
	8			40°			8 + 6			40°				
	0°	60,00	36,50	20°	60,00	36,50	0°	60,00	20°	60,00	36,50	40°		60,00
9	5,400	-	-	-	-	-	-	-	-	-	-	-	-	9
10	5,400	-	-	-	-	-	4,200	-	-	-	-	-	-	10
11	5,400	-	-	-	-	-	4,200	-	-	-	-	-	-	11
12	5,400	-	-	-	-	-	4,200	-	-	-	-	-	-	12
13	5,400	-	-	-	-	-	4,200	-	-	-	-	-	-	13
14	5,400	2,500	-	-	-	-	4,200	-	-	-	-	-	-	14
15	5,400	2,500	5,200	-	-	-	4,200	1,900	-	-	-	-	-	15
16	5,400	2,500	5,100	-	-	-	4,200	1,900	4,100	-	-	-	-	16
18	5,400	2,500	4,900	-	-	-	4,200	1,900	4,000	-	-	-	-	18
20	5,200	2,500	4,600	2,500	4,200	-	4,100	1,900	3,800	-	-	-	-	20
22	5,000	2,500	4,400	2,500	4,000	-	3,900	1,900	3,600	1,900	3,300	-	-	22
24	4,800	2,500	4,300	2,500	3,800	-	3,700	1,900	3,500	1,900	3,200	-	-	24
26	4,600	2,500	4,100	2,500	3,700	2,500	3,600	1,900	3,400	1,900	3,000	1,800	-	26
28	4,400	2,500	3,900	2,500	3,600	2,500	3,400	1,900	3,200	1,900	2,900	1,800	-	28
30	4,200	2,500	3,700	2,500	3,500	2,500	3,300	1,900	3,100	1,900	2,800	1,800	-	30
32	4,000	2,500	3,600	2,500	3,300	2,500	3,100	1,900	3,000	1,900	2,700	1,800	-	32
34	3,800	2,500	3,500	2,500	3,200	2,500	3,000	1,900	2,800	1,900	2,600	1,800	-	34
36	3,600	2,500	3,300	2,500	3,100	2,500	2,900	1,900	2,700	1,900	2,600	1,800	-	36
38	3,500	2,500	3,200	2,500	3,100	2,500	2,700	1,900	2,600	1,900	2,500	1,800	-	38
40	3,300	2,500	3,100	2,500	3,000	2,500	2,600	1,900	2,500	1,900	2,400	1,800	-	40
42	3,200	2,500	3,000	2,500	2,900	2,500	2,500	1,900	2,400	1,900	2,300	1,800	-	42
44	3,100	2,500	2,900	2,500	2,800	2,500	2,400	1,900	2,300	1,900	2,200	1,800	-	44
46	3,000	2,400	2,800	2,500	2,800	2,500	2,300	1,900	2,200	1,900	2,100	1,800	-	46
48	2,800	2,200	2,700	2,300	2,700	2,500	2,200	1,900	2,100	1,900	2,100	1,800	-	48
50	2,700	2,100	2,600	2,200	2,700	2,300	2,100	1,800	2,000	1,900	2,000	1,800	-	50
52	2,700	2,000	2,600	2,100	-	2,200	2,000	1,600	2,000	1,700	1,900	1,800	-	52
54	2,600	1,900	2,500	1,900	-	2,000	1,900	1,500	1,900	1,600	1,900	1,700	-	54
56	2,500	1,600	2,500	1,800	-	1,900	1,900	1,400	1,800	1,500	1,800	1,600	-	56
58	2,200	1,300	2,200	1,700	-	1,800	1,800	1,200	1,800	1,400	-	1,500	-	58
60	-	1,100	-	1,400	-	1,600	1,700	1,000	1,700	1,300	-	1,400	-	60
62	-	0,900	-	1,200	-	1,300	1,700	-	1,700	1,100	-	1,300	-	62
64	-	-	-	0,900	-	1,000	1,500	-	1,500	0,900	-	1,000	-	64

Load charts • Traglasten • Capacités de levage • Capacidades Caracità • Diagramas de carga • Таблицы грузоподъемности

Manual bifold swingaway • Manuelle Doppelklappspitze • Extension à double repliage latéral manuel • Extensión abatible, manual, articulada en dos secciones • Falcone ripieghevole meccanico • Extensão dupla articulada, manual • Ручной двухсекционный вывод



12,9 - 60,0 m



11,0 - 18,0 m



100 %



360°



17,7 t



EN13000

m	11,00						18,00						m
	0°		20°		40°		0°		20°		40°		
	36,50	60,00	36,50	60,00	36,50	60,00	36,50	60,00	36,50	60,00	36,50	60,00	
5	14,200	-	-	-	-	-	-	-	-	-	-	-	5
6	14,200	-	-	-	-	-	-	-	-	-	-	-	6
7	14,200	-	-	-	-	-	6,600	-	-	-	-	-	7
8	14,200	-	-	-	-	-	6,500	-	-	-	-	-	8
9	14,200	-	12,100	-	-	-	6,400	-	-	-	-	-	9
10	14,200	5,300	11,900	-	-	-	6,400	-	-	-	-	-	10
11	13,800	5,300	11,700	-	9,200	-	6,300	-	-	-	-	-	11
12	13,500	5,300	11,500	-	9,100	-	6,200	3,600	-	-	-	-	12
13	13,300	5,300	11,200	-	8,900	-	6,200	3,600	5,500	-	-	-	13
14	13,100	5,300	10,900	5,300	8,800	-	6,100	3,600	5,400	-	-	-	14
15	12,800	5,300	10,600	5,300	8,700	-	6,100	3,600	5,300	-	-	-	15
16	12,600	5,300	10,300	5,300	8,500	5,300	6,000	3,600	5,300	-	-	-	16
18	12,200	5,300	9,800	5,300	8,200	5,300	5,900	3,600	5,100	3,600	4,500	-	18
20	11,400	5,300	9,300	5,300	8,000	5,300	5,700	3,600	5,000	3,600	4,400	-	20
22	10,700	5,300	8,900	5,300	7,800	5,300	5,600	3,600	4,900	3,600	4,300	-	22
24	9,630	5,300	8,500	5,300	7,600	5,300	5,500	3,600	4,800	3,600	4,200	3,600	24
26	8,310	5,300	8,200	5,300	7,400	5,300	5,300	3,600	4,600	3,600	4,100	3,600	26
28	7,190	5,300	7,595	5,200	7,100	5,300	5,200	3,600	4,500	3,600	4,100	3,600	28
30	6,260	5,000	6,640	5,000	6,800	5,000	5,000	3,600	4,400	3,600	4,000	3,600	30
32	5,415	4,680	5,735	4,700	5,900	4,700	4,900	3,600	4,300	3,600	3,900	3,600	32
34	4,680	4,050	4,950	4,400	5,065	4,500	4,800	3,600	4,200	3,600	3,900	3,600	34
36	4,045	3,490	4,265	3,875	4,325	4,145	4,580	3,600	4,100	3,600	3,900	3,600	36
38	3,485	2,985	3,655	3,340	3,670	3,575	4,005	3,200	4,000	3,500	3,800	3,600	38
40	2,990	2,530	3,110	2,855	-	3,065	3,500	2,750	3,880	3,300	3,800	3,500	40
42	2,550	2,110	2,620	2,405	-	2,580	3,050	2,345	3,370	2,890	3,510	3,295	42
44	-	1,710	-	1,980	-	2,130	2,645	1,975	2,905	2,475	2,980	2,840	44
46	-	1,350	-	1,595	-	1,720	2,280	1,635	2,485	2,100	-	2,425	46
48	-	1,020	-	1,240	-	1,350	1,955	1,305	2,095	1,740	-	2,025	48
50	-	0,725	-	0,920	-	1,005	1,660	1,005	1,720	1,400	-	1,650	50
52	-	-	-	0,625	-	0,690	-	0,730	-	1,095	-	1,310	52
54	-	-	-	-	-	-	-	-	-	0,810	-	0,995	54
56	-	-	-	-	-	-	-	-	-	0,545	-	0,700	56



85 %

m	11,00						18,00						m
	0°		20°		40°		0°		20°		40°		
	36,50	60,00	36,50	60,00	36,50	60,00	36,50	60,00	36,50	60,00	36,50	60,00	
5	14,200	-	-	-	-	-	-	-	-	-	-	-	5
6	14,200	-	-	-	-	-	-	-	-	-	-	-	6
7	14,200	-	-	-	-	-	6,700	-	-	-	-	-	7
8	14,200	-	-	-	-	-	6,700	-	-	-	-	-	8
9	14,200	-	12,700	-	-	-	6,700	-	-	-	-	-	9
10	14,200	5,300	12,500	-	-	-	6,700	-	-	-	-	-	10
11	14,200	5,300	12,300	-	9,700	-	6,600	-	-	-	-	-	11
12	14,200	5,300	12,000	-	9,500	-	6,600	3,600	-	-	-	-	12
13	14,000	5,300	11,800	-	9,400	-	6,500	3,600	5,800	-	-	-	13
14	13,700	5,300	11,400	5,300	9,200	-	6,400	3,600	5,700	-	-	-	14
15	13,500	5,300	11,100	5,300	9,100	-	6,400	3,600	5,600	-	-	-	15
16	13,200	5,300	10,800	5,300	9,000	5,300	6,300	3,600	5,500	-	-	-	16
18	12,800	5,300	10,200	5,300	8,700	5,300	6,200	3,600	5,400	3,600	4,700	-	18
20	12,000	5,300	9,800	5,300	8,400	5,300	6,000	3,600	5,200	3,600	4,600	-	20
22	11,300	5,300	9,400	5,300	8,200	5,300	5,900	3,600	5,100	3,600	4,500	-	22
24	10,600	5,300	9,000	5,300	8,000	5,300	5,800	3,600	5,000	3,600	4,400	3,600	24
26	9,415	5,300	8,600	5,300	7,700	5,300	5,600	3,600	4,900	3,600	4,300	3,600	26
28	8,175	5,300	8,300	5,300	7,400	5,300	5,400	3,600	4,800	3,600	4,300	3,600	28
30	7,140	5,300	7,495	5,200	7,100	5,300	5,300	3,600	4,700	3,600	4,200	3,600	30
32	6,290	5,000	6,605	4,900	6,765	5,000	5,200	3,600	4,600	3,600	4,100	3,600	32
34	5,510	4,700	5,775	4,600	5,885	4,700	5,000	3,600	4,400	3,600	4,100	3,600	34
36	4,830	4,400	5,050	4,400	5,110	4,400	4,900	3,600	4,300	3,600	4,100	3,600	36
38	4,235	3,805	4,405	4,155	4,415	4,200	4,750	3,600	4,200	3,600	4,000	3,600	38
40	3,710	3,275	3,830	3,595	-	3,795	4,215	3,500	4,200	3,500	4,000	3,600	40
42	3,245	2,805	3,310	3,095	-	3,265	3,735	3,100	4,050	3,300	4,000	3,500	42
44	-	2,380	-	2,645	-	2,790	3,305	2,670	3,560	3,170	3,635	3,300	44
46	-	1,995	-	2,235	-	2,360	2,915	2,280	3,115	2,740	-	3,055	46
48	-	1,650	-	1,865	-	1,970	2,570	1,930	2,705	2,355	-	2,630	48
50	-	1,335	-	1,525	-	1,610	2,260	1,610	2,315	1,995	-	2,240	50
52	-	1,045	-	1,215	-	1,280	-	1,315	-	1,670	-	1,885	52
54	-	0,775	-	0,925	-	0,970	-	1,045	-	1,370	-	1,555	54
56	-	0,530	-	0,660	-	0,685	-	0,880	-	1,095	-	1,245	56
58	-	-	-	-	-	-	-	0,570	-	0,835	-	0,960	58
60	-	-	-	-	-	-	-	-	-	0,595	-	0,690	60

Load charts • Traglasten • Capacités de levage • Capacidades Caracità • Diagramas de carga • Таблицы грузоподъемности

Hydraulic bifold swingaway • Hydraulische Doppelklappspitze • Extension à double repliage latéral hydraulique • Abatible, hidráulica, articulada en dos secciones • Falcone ripieghevole idraulico • Extensão dupla articulada, hidráulica • Гидравлический двухсекционный вывод



12,9 - 60,0 m



11,0 - 18,0 m



100 %



360°



17,7 t



EN13000

m	11,00						18,00						m
	0° fixed		0° - 20°		20° - 40°		0° fixed		0° - 20°		20° - 40°		
	36,50	60,00	36,50	60,00	36,50	60,00	36,50	60,00	36,50	60,00	36,50	60,00	
5	14,200	-	-	-	-	-	-	-	-	-	-	-	5
6	14,200	-	-	-	-	-	-	-	-	-	-	-	6
7	14,200	-	-	-	-	-	6,600	-	-	-	-	-	7
8	14,200	-	-	-	-	-	6,500	-	-	-	-	-	8
9	14,200	-	12,100	-	-	-	6,400	-	-	-	-	-	9
10	14,200	5,300	11,900	-	-	-	6,400	-	-	-	-	-	10
11	13,800	5,300	11,700	-	9,200	-	6,300	-	-	-	-	-	11
12	13,500	5,300	11,500	-	9,100	-	6,200	3,600	-	-	-	-	12
13	13,300	5,300	11,200	-	8,900	-	6,200	3,600	5,500	-	-	-	13
14	13,100	5,300	10,900	5,300	8,800	-	6,100	3,600	5,400	-	-	-	14
15	12,800	5,300	10,600	5,300	8,700	-	6,100	3,600	5,300	-	-	-	15
16	12,600	5,300	10,300	5,300	8,500	5,300	6,000	3,600	5,300	-	-	-	16
18	12,200	5,300	9,800	5,300	8,200	5,300	5,900	3,600	5,100	3,600	4,500	-	18
20	11,400	5,300	9,300	5,300	8,000	5,300	5,700	3,600	5,000	3,600	4,400	-	20
22	10,700	5,300	8,900	5,300	7,800	5,300	5,600	3,600	4,900	3,600	4,300	-	22
24	9,630	5,300	8,500	5,300	7,600	5,300	5,500	3,600	4,800	3,600	4,200	3,600	24
26	8,310	5,300	8,200	5,300	7,400	5,300	5,300	3,600	4,600	3,600	4,100	3,600	26
28	7,190	5,300	7,190	5,200	7,100	5,200	5,200	3,600	4,500	3,600	4,100	3,600	28
30	6,260	5,000	6,260	5,000	6,640	5,000	5,000	3,600	4,400	3,600	4,000	3,600	30
32	5,415	4,680	5,415	4,680	5,735	4,700	4,900	3,600	4,300	3,600	3,900	3,600	32
34	4,680	4,050	4,680	4,050	4,950	4,400	4,800	3,600	4,200	3,600	3,900	3,600	34
36	4,045	3,490	4,045	3,490	4,265	3,875	4,580	3,600	4,100	3,600	3,900	3,600	36
38	3,485	2,985	3,485	2,985	3,655	3,340	4,005	3,200	4,000	3,200	3,800	3,500	38
40	2,990	2,530	2,990	2,530	-	2,855	3,500	2,750	3,500	2,750	3,800	3,300	40
42	2,550	2,110	2,550	2,110	-	2,405	3,050	2,345	3,050	2,345	3,370	2,890	42
44	-	1,710	-	1,710	-	1,980	2,645	1,975	2,645	1,975	2,905	2,475	44
46	-	1,350	-	1,350	-	1,595	2,280	1,635	2,280	1,635	-	2,100	46
48	-	1,020	-	1,020	-	1,240	1,955	1,305	1,955	1,305	-	1,740	48
50	-	0,725	-	0,725	-	0,920	1,660	1,005	1,660	1,005	-	1,400	50
52	-	-	-	-	-	0,625	-	0,730	-	0,730	-	1,095	52
54	-	-	-	-	-	-	-	-	-	-	-	0,810	54
56	-	-	-	-	-	-	-	-	-	-	-	0,545	56



85 %

m	11,00						18,00						m
	0° fixed		0° - 20°		20° - 40°		0° fixed		0° - 20°		20° - 40°		
	36,50	60,00	36,50	60,00	36,50	60,00	36,50	60,00	36,50	60,00	36,50	60,00	
5	14,200	-	-	-	-	-	-	-	-	-	-	-	5
6	14,200	-	-	-	-	-	-	-	-	-	-	-	6
7	14,200	-	-	-	-	-	6,700	-	-	-	-	-	7
8	14,200	-	-	-	-	-	6,700	-	-	-	-	-	8
9	14,200	-	12,700	-	-	-	6,700	-	-	-	-	-	9
10	14,200	5,300	12,500	-	-	-	6,700	-	-	-	-	-	10
11	14,200	5,300	12,300	-	9,700	-	6,600	-	-	-	-	-	11
12	14,200	5,300	12,000	-	9,500	-	6,600	3,600	-	-	-	-	12
13	14,000	5,300	11,800	-	9,400	-	6,500	3,600	5,800	-	-	-	13
14	13,700	5,300	11,400	5,300	9,200	-	6,400	3,600	5,700	-	-	-	14
15	13,500	5,300	11,100	5,300	9,100	-	6,400	3,600	5,600	-	-	-	15
16	13,200	5,300	10,800	5,300	9,000	5,300	6,300	3,600	5,500	-	-	-	16
18	12,800	5,300	10,200	5,300	8,700	5,300	6,200	3,600	5,400	3,600	4,700	-	18
20	12,000	5,300	9,800	5,300	8,400	5,300	6,000	3,600	5,200	3,600	4,600	-	20
22	11,300	5,300	9,400	5,300	8,200	5,300	5,900	3,600	5,100	3,600	4,500	-	22
24	10,600	5,300	9,000	5,300	8,000	5,300	5,800	3,600	5,000	3,600	4,400	3,600	24
26	9,415	5,300	8,600	5,300	7,700	5,300	5,600	3,600	4,900	3,600	4,300	3,600	26
28	8,175	5,300	8,175	5,300	7,400	5,300	5,400	3,600	4,800	3,600	4,300	3,600	28
30	7,140	5,300	7,140	5,200	7,100	5,200	5,300	3,600	4,700	3,600	4,200	3,600	30
32	6,290	5,000	6,290	4,900	6,605	4,900	5,200	3,600	4,600	3,600	4,100	3,600	32
34	5,510	4,700	5,510	4,600	5,775	4,600	5,000	3,600	4,400	3,600	4,100	3,600	34
36	4,830	4,400	4,830	4,400	5,050	4,400	4,900	3,600	4,300	3,600	4,100	3,600	36
38	4,235	3,805	4,235	3,805	4,405	4,155	4,750	3,600	4,200	3,600	4,000	3,600	38
40	3,710	3,275	3,710	3,275	-	3,595	4,215	3,500	4,200	3,500	4,000	3,500	40
42	3,245	2,805	3,245	2,805	-	3,095	3,735	3,100	3,735	3,100	4,000	3,300	42
44	-	2,380	-	2,380	-	2,645	3,305	2,670	3,305	2,670	3,560	3,170	44
46	-	1,995	-	1,995	-	2,235	2,915	2,280	2,915	2,280	-	2,740	46
48	-	1,650	-	1,650	-	1,865	2,570	1,930	2,570	1,930	-	2,355	48
50	-	1,335	-	1,335	-	1,525	2,260	1,610	2,260	1,610	-	1,995	50
52	-	1,045	-	1,045	-	1,215	-	1,315	-	1,315	-	1,670	52
54	-	0,775	-	0,775	-	0,925	-	1,045	-	1,045	-	1,370	54
56	-	0,530	-	0,530	-	0,600	-	0,800	-	0,800	-	1,095	56
58	-	-	-	-	-	-	-	0,570	-	0,570	-	0,835	58
60	-	-	-	-	-	-	-	-	-	-	-	0,595	60

Load charts • Traglasten • Capacités de levage • Capacidades Caracità • Diagramas de carga • Таблицы грузоподъемности

Manual bifold swingaway with inserts • Manuelle Doppelklappspitze mit Verlängerungen • Double repliage latéral manuel avec éléments intermédiaires • Abatible manual, articulada en dos secciones, con inserciones • Falcone ripieghevole meccanico con inserti • Extensão dupla articulada, manual, com inserções • Ручной двухсекционный вывод с вставками



12,9 - 60,0 m



11,0 - 18,0 m



100 %



360°



28,6 t



EN13000

m	26,00						32,00						m
	8		20°		40°		8 + 6		20°		40°		
	0°	36,50	60,00	36,50	60,00	36,50	60,00	0°	36,50	60,00	36,50	60,00	
9	5,400	-	-	-	-	-	-	-	-	-	-	-	9
10	5,400	-	-	-	-	-	4,200	-	-	-	-	-	10
11	5,400	-	-	-	-	-	4,200	-	-	-	-	-	11
12	5,400	-	-	-	-	-	4,200	-	-	-	-	-	12
13	5,400	-	-	-	-	-	4,200	-	-	-	-	-	13
14	5,400	2,500	-	-	-	-	4,200	-	-	-	-	-	14
15	5,300	2,500	4,900	-	-	-	4,200	1,900	-	-	-	-	15
16	5,300	2,500	4,800	-	-	-	4,200	1,900	3,900	-	-	-	16
18	5,200	2,500	4,600	-	-	-	4,000	1,900	3,800	-	-	-	18
20	5,000	2,500	4,400	2,500	4,000	-	3,900	1,900	3,600	-	-	-	20
22	4,800	2,500	4,200	2,500	3,800	-	3,700	1,900	3,500	1,900	3,100	-	22
24	4,600	2,500	4,000	2,500	3,700	-	3,600	1,900	3,300	1,900	3,000	-	24
26	4,400	2,500	3,900	2,500	3,500	2,500	3,400	1,900	3,200	1,900	2,900	1,700	26
28	4,200	2,500	3,700	2,500	3,400	2,500	3,300	1,900	3,100	1,900	2,800	1,700	28
30	4,000	2,500	3,600	2,500	3,300	2,500	3,100	1,900	2,900	1,900	2,700	1,700	30
32	3,800	2,500	3,400	2,500	3,200	2,500	3,000	1,900	2,800	1,900	2,600	1,700	32
34	3,600	2,500	3,300	2,500	3,100	2,500	2,900	1,900	2,700	1,900	2,500	1,700	34
36	3,500	2,500	3,200	2,500	3,000	2,500	2,700	1,900	2,600	1,900	2,400	1,700	36
38	3,300	2,500	3,100	2,500	2,900	2,500	2,600	1,900	2,500	1,900	2,300	1,700	38
40	3,200	2,500	2,900	2,500	2,800	2,500	2,500	1,900	2,400	1,900	2,300	1,700	40
42	3,000	2,245	2,900	2,500	2,800	2,500	2,400	1,900	2,300	1,900	2,200	1,700	42
44	2,805	1,880	2,800	2,410	2,700	2,500	2,300	1,795	2,200	1,900	2,100	1,700	44
46	2,435	1,545	2,700	2,040	2,600	2,405	2,200	1,460	2,100	1,900	2,000	1,700	46
48	2,095	1,235	2,370	1,700	2,490	2,030	2,100	1,160	2,000	1,640	2,000	1,700	48
50	1,790	0,955	2,025	1,385	2,095	1,680	1,850	0,875	1,900	1,330	1,900	1,650	50
52	1,515	0,690	1,705	1,090	-	1,360	1,565	0,615	1,825	1,040	1,900	1,335	52
54	1,260	-	1,405	0,820	-	1,055	1,310	-	1,530	0,770	1,610	1,035	54
56	1,030	-	1,125	0,565	-	0,775	1,070	-	1,260	0,520	1,300	0,760	56
58	0,820	-	0,855	-	-	0,510	0,850	-	1,010	-	-	0,500	58
60	-	-	-	-	-	-	0,650	-	0,770	-	-	-	60
62	-	-	-	-	-	-	-	-	0,545	-	-	-	62



85 %

m	26,00						32,00						m
	8		20°		40°		8 + 6		20°		40°		
	0°	36,50	60,00	36,50	60,00	36,50	60,00	0°	36,50	60,00	36,50	60,00	
9	5,400	-	-	-	-	-	-	-	-	-	-	-	9
10	5,400	-	-	-	-	-	4,200	-	-	-	-	-	10
11	5,400	-	-	-	-	-	4,200	-	-	-	-	-	11
12	5,400	-	-	-	-	-	4,200	-	-	-	-	-	12
13	5,400	-	-	-	-	-	4,200	-	-	-	-	-	13
14	5,400	2,500	-	-	-	-	4,200	-	-	-	-	-	14
15	5,400	2,500	5,200	-	-	-	4,200	1,900	-	-	-	-	15
16	5,400	2,500	5,100	-	-	-	4,200	1,900	4,100	-	-	-	16
18	5,400	2,500	4,900	-	-	-	4,200	1,900	4,000	-	-	-	18
20	5,200	2,500	4,600	2,500	4,200	-	4,100	1,900	3,800	-	-	-	20
22	5,000	2,500	4,400	2,500	4,000	-	3,900	1,900	3,600	1,900	3,300	-	22
24	4,800	2,500	4,300	2,500	3,800	-	3,700	1,900	3,500	1,900	3,200	-	24
26	4,600	2,500	4,100	2,500	3,700	2,500	3,600	1,900	3,400	1,900	3,000	1,800	26
28	4,400	2,500	3,900	2,500	3,600	2,500	3,400	1,900	3,200	1,900	2,900	1,800	28
30	4,200	2,500	3,700	2,500	3,500	2,500	3,300	1,900	3,100	1,900	2,800	1,800	30
32	4,000	2,500	3,600	2,500	3,300	2,500	3,100	1,900	3,000	1,900	2,700	1,800	32
34	3,800	2,500	3,500	2,500	3,200	2,500	3,000	1,900	2,800	1,900	2,600	1,800	34
36	3,600	2,500	3,300	2,500	3,100	2,500	2,900	1,900	2,700	1,900	2,600	1,800	36
38	3,500	2,500	3,200	2,500	3,100	2,500	2,700	1,900	2,600	1,900	2,500	1,800	38
40	3,300	2,500	3,100	2,500	3,000	2,500	2,600	1,900	2,500	1,900	2,400	1,800	40
42	3,200	2,500	3,000	2,500	2,900	2,500	2,500	1,900	2,400	1,900	2,300	1,800	42
44	3,100	2,500	2,900	2,500	2,800	2,500	2,400	1,900	2,300	1,900	2,200	1,800	44
46	3,000	2,300	2,800	2,500	2,800	2,500	2,300	1,900	2,200	1,900	2,100	1,800	46
48	2,715	1,945	2,700	2,300	2,700	2,500	2,200	1,900	2,100	1,900	2,100	1,800	48
50	2,390	1,620	2,600	2,045	2,685	2,300	2,100	1,615	2,000	1,900	2,000	1,800	50
52	2,090	1,325	2,280	1,720	-	1,980	2,000	1,315	2,000	1,700	1,900	1,800	52
54	1,820	1,050	1,965	1,420	-	1,650	1,870	1,040	1,900	1,435	1,900	1,695	54
56	1,575	0,800	1,670	1,140	-	1,345	1,620	0,790	1,800	1,155	1,800	1,390	56
58	1,355	0,570	1,390	0,880	-	1,065	1,385	0,555	1,540	0,895	-	1,105	58
60	-	-	-	0,645	-	0,800	1,175	-	1,290	0,655	-	0,845	60
62	-	-	-	-	-	0,555	0,975	-	1,055	-	-	0,600	62
64	-	-	-	-	-	-	0,800	-	0,825	-	-	-	64

Load charts • Traglasten • Capacités de levage • Capacidades Capacità • Diagramas de carga • Таблицы грузоподъемности

Weight reductions • Gewichtsreduzierung durch Lastaufnahmemittel • Reductions de charge
Reducciones de peso • Riduzioni di peso • Reduções de peso • Снижение веса

Auxiliary boom nose / Zusatz-Auslegerkopf / Tête de flèche auxiliaire / Cabeza auxiliar / Falconcino ausiliario in testa al braccio / Cabeça de lança auxiliar / Вспомогательный оголовок стрелы	60 kg
Hookblocks / Hakenflaschen / Moufles / Ganchos / Bozzelli / Cadernais / Крюковой блок	
118 tonne 8 sheave / Seilrollen / Réas / Poleas / Carrucole / Roldanas / блок	1148 kg
90,7 tonne 7 sheave / Seilrollen / Réas / Poleas / Carrucole / Roldanas / блок	1150 kg
9,1 t overhaul ball / 9,1 t Kugelhaken / Crochet simple de 9,1 tonnes / Ganho de bola de 9,1 toneladas / Bozzello a palla da 9,1 tonnellate / Gancho de bola de 9,1 toneladas / 9,1-крюк с шаром утяжелителем	330 kg
11-18 m bifold swingaway fly jib / Doppelklappspitze / Extension de flèche repliable / Plumín Plegable / Prolunga ripiegabile del braccio / Extensão da lança articulada. / складной удлинитель стрелы	
11 m erected / Klappspitze vorgebaut / Déplié / Montado / Montato / Montado / смонтированный	2345 kg
18 m erected / Klappspitze vorgebaut / Déplié / Montado / Montato / Montado / смонтированный	3805 kg
4 m jib erected / Spitze vorgebaut / Déplié / Montado / Montato / Montado / смонтированный	1190 kg

Note: All load handling devices and boom attachments are considered part of the load and suitable allowances must be made for their combined weights.

Hinweis: Alle Lastaufnahmemittel und jede Zusatzausrüstung des Hauptauslegers werden als Teil der Traglast betrachtet und ihre kombinierten Gewichte müssen beim Feststellen der Nettolast entsprechend berücksichtigt (abgezogen) werden.

Remarque : Les équipements complémentaires et accessoires de levage sont considérés comme faisant partie de la charge; les réductions de charges de leurs poids combinés doivent être effectuées.

Nota: Todos los aparejos de elevacion e implementos de pluma son considerados parte de la carga y deben ser tenidos en cuenta para calcular los pesos a elevar.

Nota: Tutti gli accessori di sollevamento e le opzioni montate sul braccio sono considerati parte del carico e devono essere effettuate adeguate deduzioni per i loro pesi combinati.

Nota: Todos os acessórios de elevação e opcionais de lança contribuem para a carga a elevar pelo que devem ser tidos em conta nos cálculos dos pesos a elevar

Примечание: Все погрузочно/разгрузочные устройства и дополнительные приспособления стрелы считаются частью нагрузки, поэтому в общем весе для них нужно учитывать некоторые допущения.

Load charts • Traglasten • Capacités de levage • Capacidades de carga • Diagramas de carga • Таблицы грузоподъемности

Notes • Hinweise • Notes • Notas • Note • Notas • Примечания

The lifting capacities correspond to DIN EN 13000:2014-11 and 85 %.

Warning: THIS CHART IS ONLY A GUIDE. The Notes below are for illustration only and should not be relied upon to operate the crane. The individual crane's load chart, operating instructions and other instruction plates must be read and understood prior to operating the crane.

The lifting capacities likewise fulfil the requirements of ISO 4305 and DIN 15019, Part 2, with regard to stability, and DIN 15018, Part 3, and FEM 5004 with regard to strength.

85%: Capacities are in accordance with SAE J1063 and do not exceed 85% of the tipping load (SAE J1289 for outriggers 50% and 0% extended) as determined by SAE J765.

1. Capacities given do not include the weight of hookblocks, slings, auxiliary lifting equipment and load handling devices. Their weights MUST be added to the load to be lifted. When more than minimum required reeving is used, the additional rope weight shall be considered part of the load.
2. All capacities are for crane on firm, level surface. It may be necessary to have structural supports under the outrigger floats or tyres to spread the load to a larger bearing surface.
3. When either boom length or radius or both are between values listed, the smallest load shown at either the next larger radius or boom length shall be used.
4. For outrigger operation, ALL outriggers shall be fully extended with tyres raised free of ground before raising the boom or lifting loads.
5. Tyres shall be inflated to the recommended pressure before lifting on rubber.

Die Tragfähigkeiten entsprechen DIN EN 13000:2014-11 und 85 %.

WARNUNG: DIESE TABELLE IST LEDIGLICHE EINE RICHTLINIE. Die Hinweise dienen als Erklärung und sind für die Kranbedienung nicht maßgebend. Vor Inbetriebnahme des Kranes sind Traglasttabellen, Bedienungsanleitung und andere Vorschriften eingehend zu studieren.

Die Tragfähigkeitswerte erfüllen ebenfalls die Anforderungen von ISO 4305 und DIN 15019 Teil 2 bezüglich Standsicherheit sowie von DIN 15018 Teil 3 und FEM 5004 bezüglich Festigkeit.

85%: Tragkraftwerte entsprechen SAE J1063 und überschreiten nicht 85 % der Kipplast (SAE J1289 bei halb- bzw. ganz ausgefahrener Abstützung) gemäß Richtlinien SAE J765.

1. Das Gewicht der Hakenflaschen und aller Anschlagmittel muß zu der Last hinzugerechnet werden. Beim Einsetzen mit erhöhten Werten ist das zusätzliche Seilgewicht als Teil der Last zu betrachten.
2. Alle Werte gelten für den Kran auf festem, ebenem Untergrund. Eventuell müssen die Stützsteller oder Reifen unterlegt werden, um die Last über eine größere Abstützfläche zu verteilen.
3. Wenn Auslegerlänge oder Radius oder beide Werte zwischen den aufgeführten Werten liegen, ist die geringere der Traglasten zu wählen, ist die für den die nächstgrößere Ausladung oder die nächste bzw. anschließende Auslegerlänge genannt sind.
4. In abgestützem Zustand müssen ALLE Stützen komplette ausgefahren sein. Die Reifen dürfen den Boden nicht berühren. Erst danach dürfen Lasten oder der Ausleger angehoben werden.
5. Bevor frei auf Rädern gearbeitet wird, müssen, die Reifen mit dem vorschriftsmäßigen Druck aufgefüllt werden.

Les capacités de levage sont conformes à la norme DIN EN 13000:2014-11 et 85 %.

ATTENTION: CE TABLEAU N'EST QU'UN GUIDE. Les notes ci-dessous sont données à titre d'exemple et ne devront pas être utilisées pour faire fonctionner la grue. Toute la documentation concernant chaque type de grue: tableau des charges, instructions de fonctionnement et toutes autres plaques d'instructions devront être lues et comprises avant de manoeuvrer la grue.

Les capacités de levage respectent également les exigences des normes ISO 4305 et DIN 15019, paragraphe 2, relatives à la stabilité, ainsi que celles des normes DIN 15018 paragraphe 3 et FEM 5004 relatives à la résistance.

85% : Les capacités de levage sont conformes à la norme SAE J1063 et ne dépassent pas 85% de la charge de basculement (SAE J1289 pour les poutres de calage déployées à 50% et 0%) tel que cela est prescrit par la norme SAE J765.

1. Les charges mentionnées dans les tableaux ne comprennent pas le poids des moufles, des élingues et autres accessoires de levage qui doit être additionné à celui de la charge levée. Lorsque le mouflage est supérieur au minimum requis le poids de l'excédent de câble doit être additionné à celui de la charge.
2. Les capacités sont données sur sol ferme et de niveau. Il peut être nécessaire d'utiliser des bastingis ou des accessoires similaires afin de répartir la charge transmise au sol par les roues ou les patins de calage.
3. Lorsque la longueur de flèche ou la portée ne correspond pas aux valeurs mentionnées dans les tableaux, il convient de se référer à la valeur inférieure mentionnée pour la portée ou la longueur de flèche immédiatement supérieure.
4. Pour utilisation machine calée, les poutres de calage doivent être totalement télescopées et les roues décollées du sol avant de relever la flèche ou de lever des charges.
5. Les pneumatiques devront être gonflés aux pressions recommandées avant tout levage en libre.

Las capacidades de carga corresponden a DIN EN 13000:2014-11 y 85 %.

AVISO: ESTA TABLA ES SOLO UNA ORIENTACION. Las notas que aparecen al final de la misma solo sirven de ilustración y no deben ser tomadas como instrucciones para operar la grúa. La tabla de cargas, las instrucciones de operación y otras placas ilustrativas de cada grúa deben ser leídas y correctamente interpretadas antes de operar la grúa.

Asimismo los valores de carga cumplen las disposiciones de las normas ISO 4305 y DIN 15019, 2.ª parte, respecto a la estabilidad, y DIN 15018, 3.ª parte, y FEM 5004 respecto a la fuerza.

85%: Le capacità di sollevamento sono conformi alla norma SAE J1063 e non superano l'85% del carico di ribaltamento (SAE J1289 per gli stabilizzatori estesi al 50% e 0%) come prescritto dalla norma SAE J765.

1. Las cargas indicadas no incluyen el peso de los ganchos, eslingas, equipos auxiliares y aparejos de elevación. Sus pesos DEBEN ser añadidos al de la carga a elevar. Cuando se utilice un número de ramales de cable superior al necesario, el peso adicional del cable debe ser considerado como parte de la carga.
2. Todas las capacidades corresponden a la grúa situada sobre terreno firme nivelado y uniforme. La naturaleza del terreno puede hacer necesario colocar, bajo los apoyos de los estabilizadores o bajo los neumáticos, elementos estructurales que repartan la carga sobre una mayor superficie de apoyo.
3. Cuando se trabaje con longitudes de pluma o rádios, intermedios entre los valores reflejados en las tablas, se considerará la carga inmediata inferior indicada en el radio o longitud de pluma inmediato superior.
4. Para trabajos sobre estabilizadores, TODOS los estabilizadores estarán totalmente extendidos y los neumáticos sin tocar el suelo antes de elevar pluma o izar cargas.
5. Los neumáticos deberán estar inflados a la presión recomendada antes de elevar cargas sobre neumáticos.

Le tabelle di portata sono conformi alle norme DIN EN 13000:2014-11 e 85 %.

ATTENZIONE: QUESTA TABELLA E' SOLO UNA GUIDA. Le note qui sotto riportate sono date a titolo d'esempio e non devono essere utilizzate per far funzionare la gru.

La tabella di carico, le istruzioni d'uso ed ogni altro foglio illustrativo devono essere letti e compresi prima di manovrare la gru.

I valori delle tabelle di portata sono conformi anche ai requisiti delle norme ISO 4305 e DIN 15019, Parte 2, per quanto riguarda la stabilità, ed alle norme DIN 15018, Parte 3, e FEM 5004 per quanto riguarda il calcolo di resistenza della struttura.

85%: Capacidades de acuerdo con las Normas SAE J1063 y no exceden del 85% del momento de vuelco (Normas SAE J1289 para las cargas sobre estabilizadores extendidos al 50% o sin extender 0%) como fijan las normas SAE J765.

1. I carichi indicati nelle tavole non comprendono il peso dei ganci, dei tiranti, e di nessun altro accessorio di sollevamento che deve essere aggiunto a quello del carico sollevato. Quando il numero di funi è superiore al minimo richiesto il peso addizionale della fune deve essere aggiunto a quello del carico.
2. Tutte le capacità si intendono per la gru situata su un terreno compatto livellato e uniforme. Potrebbe rendersi necessario utilizzare dei supporti strutturali, sotto gli appoggi degli stabilizzatori o sotto i pneumatici, per ripartire il carico su una superficie di appoggio maggiore.
3. Quando la lunghezza del braccio o la portata non corrispondono ai valori riportati nelle tabelle, conviene considerare il valore inferiore riportato per il raggio di lavoro o la lunghezza del braccio immediatamente superiore.
4. Per lavoro su stabilizzatori, TUTTI gli stabilizzatori devono essere completamente estesi e i pneumatici staccati da terra prima di rialzare il braccio o di sollevare carichi.
5. I pneumatici devono essere gonfiati alla pressione raccomandata prima di sollevare carichi sopra i pneumatici.

Capacidade de carga corresponde a DIN EN 13000:2014-11 e 85 %.

Atenção: ESTE QUADRO SERVE APENAS DE GUIA. As notas abaixo são dadas a mero título exemplificativo e não deverão ser utilizadas para operar a grua. Toda a documentação e instruções relativas a cada tipo de grua, nas quais se incluem o diagrama de carga da grua, as respectivas instruções de operação e outras placas com instruções, têm de ser lidas e compreendidas antes de a grua ser operada.

Capacidade de elevação também satisfazer os requisitos da norma ISO 4305 e DIN 15019, Parte 2, a estabilidade relativa, bem como os da DIN 15018 3 e GEF 5004 no que diz respeito à sua resistência.

85%: Le capacità di sollevamento sono conformi alla norma SAE J1063 e non superano l'85% del carico di ribaltamento (SAE J1289 per gli stabilizzatori estesi al 50% e 0%) come prescritto dalla norma SAE J765.

1. As capacidades indicadas não incluem o peso de cadernais, eslingas, equipamento auxiliar de elevação e dispositivos de manuseamento de cargas. Os seus pesos TEM de ser adicionados ao peso da carga a ser elevada. Sempre que for utilizada mais de que uma desmultiplicação de cabo, o peso adicional dos cabos deverá ser considerado parte da carga, devendo ser adicionado ao seu peso.
2. Todas as capacidades são indicadas para uma grua sobre uma superfície firme e nivelada. Pode ser necessário colocar suportes estruturais por baixo dos pneus ou das sapatas dos estabilizadores, para espalhar a carga por uma superfície de suporte maior.
3. Sempre que o comprimento da lança, o seu raio, ou ambos estiverem compreendidos entre os valores indicados, deve ser utilizada a carga mais baixa indicada para o raio ou para o comprimento de lança imediatamente superior.
4. Operação com estabilizadores: Antes de a lança ser erguida ou de serem elevadas cargas, TODOS os estabilizadores têm de estar totalmente estendidos, com os pneus erguidos de modo a não estarem em contacto com o solo.
5. Antes de serem elevadas cargas sobre os pneus, eles devem ser enchidos às pressões recomendadas.

Грузоподъемность соответствует DIN EN 13000:2014-11 и 85 %.

Внимание: ДАННАЯ СХЕМА ПРИВЕДЕНА ИСКЛЮЧИТЕЛЬНО В ОЗНАКОМИТЕЛЬНЫХ ЦЕЛЯХ. Нижеприведенные данные являются лишь пояснительными, на них не следует полагаться при работе с краном. Перед работой на кране следует прочесть и понять таблицы грузоподъемности, инструкцию по эксплуатации, а также инструктирующие таблички.

Кроме того, грузоподъемность удовлетворяет требованиям ISO 4305 и DIN 15019 (часть 2) в отношении устойчивости, и DIN 15018, (часть 3), и FEM 5004 в отношении прочности материала.

85%: Нагрузка соответствует стандарту SAE J1063 и не превышает 85% от удерживающего момента (SAE J1289 для выносных опор, выдвигаемых на 50% и на 0%) в соответствии с SAE J765.

1. Указанная нагрузка не учитывает вес крюковых блоков, канатов, вспомогательного подъемного оборудования и погрузочно/разгрузочных устройств. Их вес СЛЕДУЕТ прибавлять к массе груза. При превышении минимально необходимой запасаки канатаследует учитывать его дополнительный вес.
2. Все нагрузки указаны для крана, находящегося на прочной плоской поверхности. С целью распределения нагрузки, под выносные опоры или под колеса можно подложить поддерживающие конструкции для увеличения площади опоры.
3. Если длина стрелы, вылет (или и то и другое) находятся между указанными значениями в таблице, следует брать наименьшую нагрузку, указанную за следующим значением радиуса или длины стрелы.
4. Перед подъемом стрелы или грузов (при использовании выносных опор) следует выдвинуть ВСЕ выносные опоры на полную длину, чтобы колеса оказались над землей.
5. При подъеме с колес, шины должны быть накачаны до рекомендуемого давления.

Specifications

Superstructure



Boom

12,9 m – 60,0 m, six section, Megaform™ style boom with Twin-lock™ boom pinning system. Maximum tip height: 63,7 m. Eight nylatron sheaves mounted on heavy duty tapered roller bearings with removable pin-type rope guards. Quick reeve type boom nose.



Bifold swingaway extension

11,0 m - 18,0 m bifold swingaway extension. Offsets at 0°, 20° and 40°. Stows alongside base boom section. Maximum tip height: 81,4 m.



*Hydraulic bifold swingaway extension

11,0 m - 18,0 m bifold swingaway extension. Hydraulically offsettable from 0° to 40°. Stows alongside base boom section. Maximum tip height: 81,4 m.



*Hydraulic swingaway extension with heavy duty jib

11,0 m - 18,0 m bifold swingaway extension with integrated 3,6 m 3-sheave heavy duty jib. Hydraulically offsettable 0°, 20° and 40°. Stows alongside base boom section. Maximum tip height: 81,4 m.



*Lattice extension inserts

1 x 8 m and 1 x 6 m lattice extension inserts. Installs between the boom nose and bifold extension. Maximum tip height: 95,3 m.



Boom elevation

One double acting hydraulic cylinder with integral holding valve provides elevation from -3° to +78°.



Load moment and anti-two block system

Standard "Graphic Display" load moment and anti-two block system with audio-visual warning and control lever lockout. These systems provide electronic display of boom angle, length, radius, tip height, relative load moment, maximum permissible load, load indication and warning of impending two-block condition. The standard Work Area Definition System allows the operator to pre-select and define safe working areas. If the crane approaches the pre-set limits, audio-visual warnings aid the operator in avoiding job-site obstructions.



Cab

Full-vision, all-steel fabricated with acoustical lining and tinted safety glass throughout. Cab tilts to +20 degrees. Deluxe seat incorporates armrest-mounted electric dual-axis controllers. Dash panel incorporates gauges for all engine functions. Other standard features include: hot water heater, cab circulating air fan, air conditioning, sliding side and rear windows, sliding skylight with electric wiper and sunscreen, electric windshield wash/wipe, fire extinguisher and seat belt.



Slewing

Two planetary swing drive with axial piston motors provide infinitely variable rotation speeds. Foot applied multi-disc wet brake with Spring applied, hydraulically released stationary swing brake. Two position mechanical house lock, operated from cab. Maximum speed: 1,5 RPM.



Counterweight

17 690 kg. Hydraulically installed and removed.
* Additional 10 886 kg (Total 28 577 kg) hydraulically installed and removed.



Hydraulic system

Four main pumps with a combined capacity of 545 LPM. Maximum operating pressure: 275,7 bar. Three primary directional control valves with independent function sections. Return line type filter with full flow by-pass protection and service indicator. Replaceable cartridge with micron filtration rating of 10/12/5. 655 l hydraulic reservoir. System pressure test ports.



Hoist

Planetary reduction with automatic spring applied multi-disc wet brake. Electronic hoist drum rotation indicators, and hoist drum cable followers. 5th wrap indicator with function cut-out.

Maximum Single Line Pull:
• 1st layer: 10 707 kg. • 3rd layer: 9280 kg. • 5th layer: 7852 kg.
Maximum Permissible Line Pull: 7167 kg with 35x7 class rope.
Maximum Single Line Speed: 135 m/min.
Rope Construction: 35x7 WSC, Rotation Resistant. Rope Diameter: 19mm.
Rope Length: Main Hoist: 255 m - Auxiliary Hoist: 225 m.
Maximum Rope Stowage: Main hoist: 300 m - Auxiliary Hoist: 300 m.



CraneSTAR

Crane asset management system.

Carrier



Carrier frame

Box section frame fabricated from high-strength, low alloy steel. Removable outrigger boxes, front/rear towing and tie down lugs.



Outriggers

Four hydraulic telescoping single-stage double box beam outriggers with inverted jacks and integral holding valves. Three position setting, 0%, 50% and fully extended. Outrigger boxes removable for ease of transportation. All steel fabricated, quick release type outrigger floats, 775 mm diameter. Maximum outrigger pad load: 75 300 kg. Controls and crane level indicator located in cab.



Engine

Tier 3 / Euro mot 3A: Cummins QSC 8.3L diesel, six cylinders, 224 kW at 2200 rpm. Maximum torque: 1356 Nm at 1400 rpm.

Note: Required for sale outside of North America and European Union countries.

Tier 4f / Euro mot 4: Cummins QSL 8.3L diesel, six-cylinder, turbo charged with Cummins diesel particulate exhaust filter/muffler. Meets U.S. E.P.A. Tier IV and E.U. Stage IIIB. 239 kW at 2200 rpm. Maximum torque: 1383 Nm at 1500 rpm. Fuel requirements: Maximum of 15 PPM sulphur content (Ultra Low Diesel Fuel) Note: Tier IV engine required in North America and European Union countries.

Fuel tank capacity: 379 l.



Transmission

Range-shift 6 x 3 speed (3 speeds x 2 range) 6 forward and 3 reverse. Front axle disconnect for 4 x 2 travel.



Drive/Steer

4 x 4. Fully independent power steering:

Front: Full hydraulic steering wheel controlled.

Rear: Full hydraulic switch controlled.

Provides infinite variations of 4 main steering modes: front only, rear only, crab and coordinated. Rear steer indicator. Turning radius: 9,7 m.



Axles

Front: Drive/steer with differential and planetary reduction hubs rigid mounted to frame.

Rear: Drive/steer with differential and planetary reduction hubs pivot mounted to frame.



Tyres

Std. 33,25 X 29 - 38 bias ply.



Brakes

Dry disc, full hydraulic split circuit operating on all wheels. Spring-applied, hydraulically released parking brake mounted on front axle.



Lights

Full lighting including turn indicators, head, tail, brake and hazard warning lights.



Maximum speed

24 km/h.



Gradeability (theoretical)

70% (at engine stall) Based on 87 751 kg GVW, 33,25 x 29 tires, 60,0 m main boom, 11,0-18,0 m manual bi-fold swingaway, 17 690 kg counterweight, 90 t hookblock and 9,0 t headache ball.



Electrical system

Four 12 V - maintenance free batteries. 24 V starting and lighting, circuit breakers. CanBus Diagnostic system.

* Optional equipment

- Auxiliary lighting package (includes cab mounted amber flashing light, hoist mounted work light, single base boom mounted floodlights and rubber mat for stowage trough).
- Heavy Lift counterweight package
- ECOS event recorder
- Hardwired wind speed indicator
- Rear Pintle Hook
- Boom mounted aircraft warning light
- -28°C (-20°F) cold weather package
- Hydraulic bi-fold swingaway
- Hydraulic bi-fold swingaway with heavy duty jib
- Boom extension inserts
- CE mark conformance

*Denotes optional equipment

Kranoberwagen

Ausleger

12,9 m – 60,0 m, sechs Sektionen, Megaform™ Ausleger mit Twin-lock™ Ausleger-Verriegelungssystem. Maximale Arbeitshöhe: 63,7 m. Acht Nylatron-Seilrollen auf Kegelrollenlagern in schwerer Ausführung mit verbolztem, abnehmbarem Seilschutz. Auslegerkopf mit Schnelleinsicherung.

Doppelklappspitze

Klappspitzenausleger in Gitterbauweise, 11,0 m bis 18,00 m. Abwinkelung 0°, 20° und 40°. Neben dem Ausleger-Grundstück verstaubar. Maximale Arbeitshöhe : 81,4 m.

*Hydraulische Doppelklappspitze

Klappspitzenausleger in Gitterbauweise, 11,0 m bis 18,00 m. Hydraulisch zwischen 0° und 40° abwinkelbar. Neben dem Ausleger-Grundstück verstaubar. Maximale Arbeitshöhe : 81,4 m.

*Hydraulische Klappverlängerung mit Schwerlastausleger

11,0 m - 18,0 m Doppelklappspitze mit integriertem 3,6 m Schwerlastausleger und 3 Seilrollen. Hydraulisch auf 0°, 20° und 40° abwinkelbar. Neben dem Ausleger-Basisstück verstaubar. Maximale Arbeitshöhe : 81,4 m.

*Zwischenstücke für Doppelklappspitze

1 x 8 m und 1 x 6 m Zwischenstücke für Doppelklappspitze. Anbau zwischen Auslegerkopf und Doppelklappspitze. Maximale Arbeitshöhe : 95,3 m.

Wippwerk

Ein doppelt wirkender Hydraulikzylinder mit integriertem Sicherheits-Rückschlagventil. Auslegerverstellwinkel von -3° bis +78°.

Lastmoment- und Hubendschalter-System

System für Lastmomentbegrenzung über Standard-„Grafikdisplay“ und Anti-Two Block System mit akustisch-optischer Warnung und Steuerhebelsperre. Diese Systeme bieten elektronische Anzeige von Auslegerwinkel, Auslegerlänge, Radius, Arbeitshöhe, relativem Lastmoment, maximal zulässiger Last, Hakenlast und Hubendschaltungs-Vorrichtung. Das zur Standardausrüstung gehörende System zur Arbeitsbereichsbegrenzung ermöglicht es dem Bediener, sichere Arbeitsbereiche vorzugeben und zu definieren. Nähert sich der Kran der Begrenzung des sicheren Arbeitsbereichs, wird der Bediener akustisch und optisch gewarnt, wodurch Kollisionen am Einsatzort vermieden werden.

Kabine

Rundsichtkabine, in Stahlblech ausgeführt, mit Schalldämmung und getöntem Sicherheitsglas. Kabine lässt sich um +20 Grad neigen. Komfortsitz mit in die Armlehnen integrierten, einachsigen verstellbaren Steuerhebeln. Armaturenbrett mit Anzeigen für alle Motorfunktionen. Weitere Standardausrüstung: Heißwasserheizung, Umluftgebläse, Schiebefenster seitlich und hinten, Dachschiebefenster mit elektrischem Scheibenwischer und Sonnenschutz, elektrischer Frontscheibenwischer/Waschanlage, Feuerlöscher und Sicherheitsgurt. Klimaanlage.

Schwenkwerk

Zweistufiges Planetenschwenkwerk mit fußbetätigter Mehrscheiben-Ölbadbremse. Hydraulisch lösbare Federspeicher-Feststellbremse. 360° Schwenkwerkverriegelung und in zwei Stellungen festsetzbare Bolzenverriegelung, beide von der Kabine aus bedienbar. Max. Drehgeschwindigkeit: 1,5 RPM.

Gegengewicht

Gegengewicht 17 690 kg, hydraulisch an- und abbaubar.
* Zusätzliche 10.886 kg (Gesamt 28.577 kg) hydraulisch angebaut und entfernt.

Hydrauliksystem

Vier Hauptpumpen mit einer Gesamtfördermenge von 545 l/Min. Maximaler Betriebsdruck: 275,7 bar. Drei Haupt-Wegeventile mit unabhängigen Funktionsabschnitten. Filter mit Vollstrom-Bypassschutz und Wartungsanzeige im Rücklauf. Wechselpatrone mit einer Filtrierleistung von 10/12/5. Fassungsvermögen des Hydrauliköltanks: 655 Liter. Systemdruck-Prüfanschlüsse.

Hubwerk

Planetenumsetzungsgetriebe mit automatischer Federspeicher-Mehrscheibenbremse. Elektronische Umdrehungsanzeigen für Hubwerkstrommeln und Hubseilberuhiger. 5-Lagen-Anzeige mit Abschaltvorrichtung. Maximaler Seilzug mit einfachem Strang:

• Erste Lage: 10 707 kg • Dritte Lage: 9280 kg • Fünfte Lage: 7852 kg

Maximal zulässiger Seilzug: 7167 kg mit Seil Kategorie 35 x 7.

Maximale Seilgeschwindigkeit mit einfachem Strang: 135 m/Min.

Seilaufbau : 35x7 WSC, drallfrei. Seildurchmesser: 19mm.

Seillänge: Haupthubwerk : 255 m. Hilfshubwerk : 225 m.

Hubwinde für max. 300 m Seil ausgelegt.

CraneSTAR

Krananlagegüterverwaltungssystem

Kranunterwagen

Rahmen

Kastenprofilrahmen aus hochfestem Feinkornstahl. Abschlepp- und Verzurrösen vorne/hinten.

Abstützungen

Vier hydraulisch teleskopierbare, einteilige Kastenprofil-Abstützträger mit innen geführten Stützzyllindern und integrierten Halteventilen. Drei Stellungen: 0%, 50% und voll ausgefahren. Abnehmbare Abstützung für einfachen Transport. Abstützteller mit Schnellentriegelung aus Stahl, Durchmesser 775 mm. Maximale Last auf den Abstützstellern: 75 300 kg. Bedienelemente und Nivellieranzeige in der Kabine.

Motor

Tier 3 / Euromot 3A: Cummins QSC 8,3 Liter Sechszylinder-Dieselmotor, 224 kW (brutto) bei 2 200 U/Min. Max. Drehmoment : 1356 Nm bei 1 400 U/Min. Hinweis: Zum Verkauf außerhalb Europas und Nordamerikas bestimmt.

Tier 4f / Euromot 4: Cummins QSL 8,3 Liter Dieselmotor, sechs Zylinder, mit Turbolader und Cummins-Dieselfußpartikelfilter/-dämpfer. Entspricht Emissionsvorgaben nach U.S.E.P.A. Tier IV und E.U. Stage III B. 239 kW bei 2200 U/min. Maximales Drehmoment: 1383 Nm bei 1500 U/min. Treibstoffart: Maximal 15 ppm Schwefelanteil (besonders schwefelarmer Dieselmotortreibstoff). Hinweis: Diese Motoren sind zum Verkauf in Nordamerika und der Europäischen Union bestimmt. Kraftstoffbehälter: 379 l.

Getriebe

Umschaltung für 6 x 3 Geschwindigkeiten (3 Geschwindigkeiten x 2 Bereiche) 6 vorwärts 3 rückwärts.

Antrieb/Lenkung

4 x 4.

Separate Servolenkung :

Vorne : Vollhydraulisch, über Lenkrad betätigt.

Hinten : Vollhydraulisch, über Schalter betätigt.

Stellt vier stufenlos veränderliche Lenkkarten bereit : Nur vorne, nur hinten, Hundegang und koordiniert. Lenkungsanzeige hinten. Wendekreis : 9,7 m.

Achslinien

Vorne: Antrieb/Lenkung über Differenzial und Planetenumsetzungsgetriebe, fest mit dem Rahmen verbunden.

Hinten: Antrieb/Lenkung über Differenzial und Planetenumsetzungsgetriebe, pendelnd mit dem Rahmen verbunden.

Bereifung

Standard 33,25 x 29 – 38-lagig, Diagonalreifen.

Bremsen

Trockenscheibe, vollhydraulische Bremsen mit geteilten Bremskreisen, auf alle Räder wirkend. Hydraulisch lösbare Federspeicher-Feststellbremse, auf die Vorderachse wirkend.

Beleuchtung

Volle Beleuchtungsanlage mit Blinkleuchten, Scheinwerfern, Schluss- und Bremsleuchten und Warnblinkanlage.

Höchstgeschwindigkeit

24 km/h.

Steigvermögen (theoretisch)

70% (bei Motorabstellung) Basierend auf 87.751 kg Bruttogewicht, Reifengröße 33,25 x 29, 60,0 m Hauptausleger, 11,0-18,0 m manuelle Doppelklappspitze, 17.690 kg Gegengewicht, 90 t Hakenflasche und 9,0 t Kugelhaken.

Elektrische Anlage

Vier wartungsfreie 12-Volt-Batterien. 24-V-Anlasser und Beleuchtung, Sicherungsschalter. CanBus Diagnosesystem.

* Zusatzausrüstung

- Zusatzbeleuchtung (einschl. kabinenmontierte Rundumleuchte, auf der Winde montiertes Arbeitslicht, am Ausleger-Basisstück montierte Flutlichter und Gummimatte für Staufach).
- Schwergut-Gegengewichtspaket • ECOS Ereignisspeicher
- festverdrahteter Windgeschwindigkeitsanzeiger • Abschleppöse hinten • auf dem Ausleger montierte Warnleuchte für Luftfahrzeuge • -28°C (-20°F) Kaltwetterpaket
- Hydraulische Doppelklappspitze • Hydraulische Doppelklappspitze mit Schwerlastausleger • Ausleger-Verlängerungseinsätze • CE-zertifiziert

Caractéristiques techniques

Superstructure



Flèche

Flèche de 12,9 m à 60,0 m, à six éléments, de style Megaform™ avec système de brochage de flèche Twin-lock™. Hauteur maximum de la tête de flèche : 63,7 m. Huit poulies Nylatron montées sur des roulements à rouleaux coniques à haute résistance et anti-dérailleurs. Tête de flèche à mouflage rapide.



Extension treillis à double repliage

Extension treillis à double repliage latéral de 11,0 m à 18,0 m. Possibilité de déport à 0°, 20° et 40°. Repliage le long de l'élément de flèche de base. Hauteur max. de tête d'extension : 81,4 m.



*Extension treillis à double repliage hydraulique

Extension treillis à double repliage latéral de 11,0 m à 18,0 m. Possibilité de déport hydraulique à 0°, 20° et 40°. Repliage le long de l'élément de flèche de base. Hauteur max. de tête d'extension : 81,4 m.



*Extension hydraulique à repliage latéral avec flèche haute résistance

Extension de 11,0 m à 18,0 m à repliage latéral avec flèche haute résistance de 3,6 m à 3 poulies. Possibilité de déport hydraulique de 0°, 20° et 40°. Repliage le long de l'élément de flèche de base. Hauteur max. d'extension treillis : 81,4 m.



*Éléments intermédiaires pour extension de treillis

Un élément de 8 m et un de 6 m installés entre la tête de flèche et l'extension treillis. Hauteur max. d'extension treillis : 95,3 m.



Relevage

Un vérin hydraulique double effet avec clapet anti-retour intégré. Angles de relevage -3° à +78°.



Contrôleur d'état de charge et dispositif de fin de course haute crochet indépendant

En standard, contrôleur d'état de charge à affichage graphique et dispositif de course haute avec alarmes sonores et visuelles et dispositif de coupure des mouvements. Ces dispositifs donnent un affichage graphique de l'angle et de la longueur de flèche, de la portée, de la hauteur de tête de flèche, du moment relatif, de la charge maximum autorisée, de la charge levée et de sécurité de fin de course haute crochet. Le dispositif standard de limitation du domaine d'évolution (Work Area Definition System) permet à l'utilisateur de pré-définir et limiter le domaine de travail autorisé.



Cabine

Cabine panoramique tout acier avec isolation sonore et vitrages de sécurité teintés, inclinable à 20°. Siège ergonomique équipé de manipulateurs multidirectionnels électriques doubles-axes intégrés aux accoudoirs. Tableau de bord équipé de tous les instruments nécessaires à la surveillance du moteur. Autres équipements montés en standard : colonne de direction réglable en inclinaison, chauffage de cabine à eau chaude, ventilateur, vitrages coulissants latéraux et arrière, vitre de toit coulissante équipée d'un essuie-glace et d'un rideau pare-soleil, essuie-glace et lave-glace de pare-brise, extincteur et ceinture de sécurité, air conditionné.



Orientation

Réducteur d'orientation à planétaires, frein multi-disques immergés à commande au pied. Serrage par ressorts et desserrage hydraulique. Blocage d'orientation positive sur 360° et verrouillage mécanique d'orientation sur deux positions, le tout commandé depuis la cabine. Vitesse maximale : 1,5 tpm.



Contrepoids

Contrepoids de 17 690 kg à mise en place et dépose hydraulique.
* Contrepoids additionnel de 10 886 kg (total 28 577 kg) à mise en place et dépose hydraulique



Système hydraulique

Quatre pompes principales donnant un débit combiné de 545 litres/min. Pression maximum de service : 275,7 bars. Trois soupapes de commande directionnelle primaires à sections de fonctionnement indépendantes. Filtre hydraulique sur circuit de retour avec protection par dérivation plein débit et indicateur de colmatage. Cartouche amovible avec classe de filtration micrométrique 10/12/5. Réservoir de 655 litres. Prises de pressions rapides.



Treuil

Entraînement par réducteur à planétaires et frein humide multi-disques à ressorts automatiques. Indicateur électronique de rotation du treuil et dispositif presse-câble. 5° indicateur de circuit avec coupure de fonction. Efforts max. sur brin simple :
• 1^{ère} couche : 10 707 kg. • 3^e couche : 9280 kg. • 5^e couche : 7852 kg.
Effort max. autorisé sur brin simple : 7167 kg avec câble de classe 34x37.
Vitesse max. de déroulement : 135 m/min. Câbles antigiratoires type 35x7 WSC. Diamètre : 19 mm. Longueur de câble : Treuil principal : 255 m et auxiliaire : 225 m. Capacité maximum de câble par treuil : 300 m



CraneSTAR

Système de gestion de parc de grues

Châssis



Châssis

Châssis caissonné mécanosoudé en acier à haute limite élastique. Carters de dispositifs de calage amovibles, chapes de remorquage et d'arrimage à l'avant et à l'arrière.



Dispositif de calage

Quatre poutres de calage hydrauliques télescopiques avec vérins inversés et clapets anti-retour intégrés. Calage autorisé en trois positions : 0 – 50% et 100%. Systèmes de calage amovibles pour faciliter le transport. Patins d'appui en acier (775 mm de diamètre) avec dispositifs de fixation rapide. Charge maximum sur appui : 75 300 kg. Commandes de calage et indicateur de niveau dans la cabine.



Moteur

Tier 3 / Euromot 3A: Diesel 6 cylindres Cummins QSC 8,3 L développant 224 kW à 2200 tours/min. Couple maximum : 1356 Nm à 1 400 tours/min. Note : Requis pour les ventes hors des pays d'Amérique du Nord et de l'Union européenne.

Tier 4f / Euromot 4: Diesel 6 cylindres turbocompressé Cummins QSL 8,3 L avec filtre/silencieux d'échappement à particules Cummins diesel. Respecte les exigences en matière d'émissions selon l'U.S.E.P.A. Tier IV et U.E. Phase III B. 239 kW à 2200 tr/min. Couple maximal : 1383 Nm à 1500 tr/min. Exigences relatives au carburant : Maximum de 15 ppm de teneur en soufre (carburant diesel à très faible teneur). Note : Moteur Tier IV requis dans les pays d'Amérique du Nord et de l'Union européenne.

Capacité du réservoir : env. 379 l



Boîte de vitesse

6 x 3 rapports à sélection de gamme (3 rapports x 2 gammes) 6 marches avant et 3 marches arrière. Débrayage de pont avant pour déplacement en 4 x 2.



Direction/transmission

4 x 4.

Direction hydraulique indépendante :

Avant : Direction hydraulique indépendante actionnée par volant.

Arrière : Direction hydraulique indépendante commandée par interrupteur au tableau de bord.

Combinaisons infinies des quatre modes de direction : avant uniquement, arrière uniquement, marche en crabe et mode coordonné. Indicateur de direction arrière. Rayon de braquage : 7,5 m.



Ponts

Avant : Pont moto-directeur avec différentiel et réductions à planétaires dans les moyeux fixé de manière rigide au châssis.

Arrière : Pont moto-directeur avec différentiel et réductions à planétaires dans les moyeux articulé au châssis



Pneumatiques

Pneumatiques standard 33,25 x 29 à carcasse conventionnelle 38 plis.



Freins

Disques secs, freinage sur toutes les roues avec circuit scindé entièrement hydraulique. Frein de stationnement à serrage par ressorts et desserrage hydraulique sur l'essieu avant.



Eclairage

Eclairage complet incluant les clignotants, ainsi que les feux avant, arrière, de freinage et de détresse.



Vitesse maximum

24 km/h.



Aptitude théorique en pente

70% (calage du moteur) basé sur un véhicule d'un poids total de 87 751 kg, équipé de pneus 33,25 x 29, d'une flèche principale de 60,0 m, d'une extension à double repliage latéral manuel de 11,0-18,0 m, d'un contrepoids de 17 690 kg, d'un bloc de crochet de 90 t et d'une boule de démolition de 9,0 t.



Installation électrique

Quatre batteries sans entretien de 12 Volts. Démarrage et éclairage 24 V. Coupe circuit. Système de diagnostic Canbus.

* Equipements optionnels

- Éclairage auxiliaire (inclut un gyrophare orange sur la cabine, un projecteur de travail sur le treuil, un projecteur installé sur la flèche de base et un tapis de caoutchouc pour le coffre de stockage)
- Contrepoids pour charge lourdes
- Enregistreur d'événement ECOS
- Indicateur de vitesse de vent câblé
- Crochet d'attelage arrière
- Feu d'avertissement pour aéronefs installé sur la flèche
- Équipement pour temps froid -28°C (-20°F)
- Extension à double repliage latéral hydraulique
- Extension à double repliage latéral hydraulique avec flèche haute résistance
- Éléments intermédiaires d'extension de flèche
- Conformité CE.

Superestructura



Pluma

Pluma de diseño Megaform™ de 12,9 m – 60,0 m, seis secciones, con sistema de anclaje de pluma Twin-lock™. Altura máxima de la punta al suelo: 63,7 m. Ocho poleas de nylon montadas sobre rodamientos de rodillos cónicos altamente resistentes con protectores de cable extraíbles de tipo pasador. Punta de pluma de tipo fijación rápida.



Plumín de celosía

Plumín de celosía articulado en dos secciones de 11,0 m - 18,0 m. Angulable 0º, 20º y 40º. Plegable junto al tramo base de la pluma. Altura máxima en punta: 81,4 m.



*Plumín de celosía con angulación hidráulica

Plumín de celosía articulado en dos secciones de 11,0 m - 18,0 m. Hidráulicamente angulable de 0º a 40º. Plegable junto al tramo base de la pluma. Altura máxima en punta: 81,4 m.



*Plumín de celosía con plumín integrado de carga pesada

Plumín de celosía articulado en dos secciones de 11,0 m - 18,0 m, con plumín integrado de carga pesada de 3,6m con tres poleas. Hidráulicamente angulable de 0º a 40º. Plegable junto al tramo base de la pluma. Altura máxima en punta: 81,4 m.



*Extensiones de pluma

Secciones adicionales de celosía, 1 x 8 m y 1 x 6 m. Se instalan entre la punta de pluma telescópica y el plumín articulado en dos secciones. Altura máxima en punta: 95,3 m.



Elevación de pluma

Un cilindro hidráulico de doble efecto con válvula de retención integrada logrando elevación entre -3º y +78º.



Sistema indicador del momento de carga y de final de carrera del gancho

Momento de carga estándar "con indicador gráfico" y sistema antibloqueo doble con señal de aviso sonora y visual y bloqueo de la palanca de control. Estos sistemas proporcionan la visualización en una pantalla electrónica del ángulo, longitud, radio, altura de la punta al suelo, momento de carga relativo, carga máxima admisible, indicación de carga y aviso del estado del bloqueo doble inminente de la pluma. El sistema de definición del área de trabajo estándar permite al operario preseleccionar y definir zonas de trabajo seguras. Si la grúa se acerca a los límites predefinidos, una señal de aviso sonora y visual ayuda al operario a evitar obstrucciones en el lugar de la obra.



Cabina

Cabina de visión panorámica, toda ella fabricada en acero con revestimiento acústico y cristal de seguridad tintado por completo. La cabina bascula hasta +20 grados. Asiento de lujo que incorpora los controles eléctricos de operación montados en reposabrazos. El panel de instrumentos incorpora indicadores para todas las funciones del motor. Forman parte del equipo de serie: volante regulable en altura, calefacción de agua, ventilador para la cabina, ventanillas laterales y traseras deslizantes, ventana superior abatible con limpia-parabrisas eléctrico y parasol, extintor y cinturón de seguridad. Aire acondicionado.



Rotación

De dos velocidades, giro deslizante mediante planetarios con freno de discos múltiples accionado por pedal. Freno de giro accionado mediante resorte con desconexión hidráulica. Bloqueo de giro en los 360º y bloqueo interno mecánico de dos posiciones accionados desde la cabina. Velocidad máxima: 1,5 rpm.



Contrapeso

17 690 kg. Instalado y desmontado hidráulicamente. Contrapeso opcional de 10 886 kg (Total 28 577 kg) instalado y desmontado hidráulicamente.



Sistema hidráulico

Cuatro bombas principales con una capacidad combinada de 545 LPM. Presión de funcionamiento máxima: 275,7 bares. Tres válvulas de control direccionales primarias con secciones de función independientes. Filtro con línea de retorno con protección total ante derivaciones de flujo e indicador de mantenimiento. Cartucho reemplazable con una tasa de microfiltrado de 10/12/5. Depósito hidráulico de 655 L. Puertos de prueba de presión del sistema.



Especificaciones del mecanismo de elevación

Reducción planetaria con freno automático de discos múltiples aplicado mediante resorte. Indicadores electrónicos de rotación del tambor del cabrestante y guías del cable del tambor del cabrestante. Indicador 5º ciclo con recorte de función. Tensión máxima de un solo ramal de cable:

• Primera capa: 10 707 kg. • Tercera capa: 9280 kg. • Quinta capa: 7852 kg. Tracción máxima admisible del cable: 7167 kg con cable 35 x 7.

Velocidad máxima de un solo cable: 135 m/min

Estructura del cable : 35x7 WSC, antirrotación. Diámetro del cable : 19 mm.

Longitud del cable : Cabrestante principal : 255 m y auxiliar : 225 m.

Capacidad máxima de cable en el tambor : 300 m.



CraneSTAR

Sistema de gestión de flotas de grúas

RT9150E

Chasis



Bastidor

Estructura del chasis tipo cajón fabricada en acero de alta resistencia. Cajones de las vigas de los estabilizadores desmontables. Orejetas de amarre y gancho de arrastre.



Estabilizadores

Cuatro estabilizadores hidráulicos telescópicos de doble viga con gatos invertidos y válvulas de retención integradas. Tres ajustes de posición: 0%, 50% y totalmente extendidos. Cajones de los estabilizadores extraíbles para facilitar el transporte. Placas base de los estabilizadores de accionamiento rápido, fabricadas completamente de acero de 775 mm de diámetro. Carga máxima sobre cada placa de apoyo de: 75.300 kg. Controles e indicador del nivel de la grúa situados en la cabina.



Motor

Tier 3 / Euromot 3A: Cummins QSC 8,3 L diesel seis cilindros, 224 kW a 2200 rpm. Par motor máximo: 1356 Nm a 1400 rpm. Nota: Necesario para la venta fuera de los países norteamericanos y de la Unión Europea.

Tier 4f / Euromot 4: Cummins QSL 8,3 l, seis cilindros, turbocargado con silenciador/filtro Cummins de tubo escape de partículas diésel. Cumple los estándares de emisiones Tier IV de la U.S.E.P.A. y Fase IIIB de la U.E. 239 kW a 2200 rpm. Par máximo: 1383 Nm a 1500 rpm. Exigencias de combustible: máximo de 15 ppm de contenido de azufre (diesel de muy bajo contenido en azufre). Nota: motor Tier IV necesario en los países norteamericanos y de la Unión Europea. Capacidad del depósito de combustible: 379 litros.



Transmisión

Caja de cambios automática de 6 velocidades adelante y 3 atrás. Desconexión del eje frontal para un desplazamiento 4 x 2.



Tracción/Dirección

4 x 4.

Dirección totalmente asistida independiente entre ejes :

Delantera : Totalmente hidráulica, controlada por volante.

Trasera : Totalmente hidráulica, controlada por interruptor.

Infinitamente variable en los 4 modos de dirección principales : sólo delantera, sólo trasera, control de giro (tipo cangrejo) y coordinada.

Indicador de dirección trasera. Radio de giro: 7,5 m.



Ejes

Delantero : Tracción/dirección con reducción planetaria y diferencial, montaje rígido en la estructura.

Trasero : Tracción/dirección con reducción planetaria y diferencial, montaje pivotante en la estructura.



Neumáticos

Estándar 33,25 x 29 – 38 lonas.



Frenos

Disco seco, circuito parcial totalmente hidráulico operativo en todas las ruedas.

Freno de estacionamiento montado sobre el eje delantero que se acciona mediante resorte y se libera hidráulicamente.



Luces

Iluminación completa que incluye intermitentes, indicadores superiores, traseros, de freno y de peligro.



Velocidad máxima

24 km/h.



Inclinación (teórica)

70% (durante el calado del motor) Basado en 87.751 kg de peso, neumáticos de 33,25 x 29, cabrestante principal de 60,0 m, extensión abatible manual articulada en dos secciones de 11,0-18,0 m, contrapeso de 17.690 kg, bloque de gancho de 90 t y bola de servicio de 9,0 t.



Sistema eléctrico

Cuatro baterías de 12 V libres de mantenimiento. Arranque e iluminación de 24 V, disyuntores diferenciales. Sistema de diagnóstico CanBus.

* Equipamiento opcional

• Equipo de iluminación auxiliar (incluye luz intermitente de color ámbar montada en la cabina, luz de trabajo montada en el cabrestante, focos montados en la pluma de una sola base y alfombrilla de goma para el hueco de almacenaje). • Equipo de contrapeso de gran carga • Registrador de eventos ECOS • Indicador de velocidad del viento cableado • Gancho de tracción trasera • Luz de advertencia de avión montada en la pluma • Equipo de clima frío -28 °C (-20 °F) • Extensión abatible, articulada en dos secciones, hidráulica • Extensión abatible, articulada en dos secciones, con brazo altamente resistente • Inserciones de extensión de pluma • Conformidad con el marcado CE

*Indica equipo opcional.

Caratteristiche tecniche

Sovrastruttura



Braccio

Braccio da 12,9 m – 60,0 m, 6 sezioni tipo Megaform™ con sistema di spinatura Twin-lock™. Altezza massima in punta 63,7 m. Testa braccio a otto carrucole in nylon montate su cuscinetti a rullo adatti a impieghi pesanti e protezione fune con perni rimovibili. Falconcino supplementare ad una carrucola montata sulla testa del braccio.



Jib doppio ripieghevole

Jib tralicciato ripieghevole da 11,0 - 18,0 m. Inclinabile a 0°, 20° e 40°. Alloggiabile e trasportabile lungo la sezione di base del braccio telescopico. Altezza massima in punta 81,4 m.



*Jib doppio ripieghevole idraulico

Jib tralicciato ripieghevole da 11,0 - 18,0 m inclinabile idraulicamente da 0° a 40°. Alloggiabile e trasportabile lungo la sezione di base del braccio telescopico. Altezza massima in punta 81,4 m.



*Jib doppio ripieghevole idraulico con falconcino per impieghi pesanti integrato

Jib tralicciato ripieghevole da 11,0 - 18,0 m inclinabile idraulicamente da 0° a 40° con falcone da montaggi integrato da 3,6 m a tre carrucole. Stivabile e trasportabile lungo la sezione del braccio base. Altezza massima in punta 81,4 m.



*Sezioni intermedie

Prolunghe ad inserti tralicciati 1 x 8 m e 1 x 6 m. Da installare fra la testa del braccio e il jib ripieghevole. Altezza massima in punta: 95,3 m.



Sollevamento braccio

Un cilindro idraulico a doppia azione con valvola di blocco integrale fornisce il sollevamento braccio con angolo da -3° a +78°.



Limitatore di carico e finecorsa

Momento di carico standard con display grafico, sistema anti-doppio bloccaggio con allarme e bloccaggio dei movimenti. Visualizzazione grafica dell'angolo del braccio, lunghezza, raggio, altezza in punta, indicazione del carico e del carico ammissibile massimo. Il sistema standard di definizione dell'area di lavoro permette all'operatore di preselezionare e definire le aree di lavoro sicure. Se l'autogru si avvicina ai limiti preimpostati, degli allarmi acustici e visivi aiutano l'operatore ad evitare gli ostacoli sul posto di lavoro.



Cabina

Ottima visibilità, costruita completamente in acciaio, insonorizzata. La cabina si inclina fino a +20°. Il sedile ergonomico è dotato di comandi elettrici a doppio asse integrati nei braccioli. Il cruscotto incorpora la strumentazione per tutte le funzioni del motore. Altre caratteristiche standard comprendono: volante inclinabile, riscaldamento ad acqua, ventola per la circolazione dell'aria nella cabina, finestrini scorrevoli, lava/tergicristallo elettrico, estintore e cintura di sicurezza. Aria condizionata.



Rotazione

Due riduttori planetari con motori a pistone assiale con velocità di rotazione infinitamente variabile. Freno multidisco con comando a pedale, freno di stazionamento a rilascio idraulico. Bloccaggio meccanico della rotazione a due posizioni comandato dalla cabina. Velocità massima: 1,5 giri/minuto



Contrappeso

17 690 kg. Installazione e rimozione idraulica.
* 10 886 kg supplementari (totale 28 577 kg) con installazione e rimozione idrauliche.



Impianto idraulico

Quattro pompe principali con capacità totale di 545 l/min. Pressione massima operativa: 275,7 bar. Tre valvole primarie di controllo direzionale con sezioni a funzione indipendente. Filtro con protezione by-pass del flusso totale e indicatore di manutenzione. Cartuccia sostituibile con grado di filtrazione micron di 10/12/15. Serbatoio idraulico da 655 l. Porte di prova pressione sistema.



Argano principale e ausiliario

Riduttore a planetari con freno multidisco automatico a bagno d'olio azionato a molla. Indicatori elettronici di rotazione del tamburo e guide per cavo sul tamburo dell'argano. Indicatore 5° avvolgimento con funzione di blocco totale.

Tiro massimo con singola fune:
• Primo strato: 10 707 kg. • Terzo strato: 9280 kg. • Quinto strato: 7852 kg.
Tiro massimo ammissibile sulla fune: 7167 kg con fune di classe 35X7
Velocità massima con fune singolo: 135 m/min.
Costruzione della fune: 35x7 Flex-X, resistente alla rotazione.
Diametro fune: 19 mm.

Lunghezza della fune: argano principale 255 m – argano ausiliario 225 m
Massima capacità di avvolgimento della fune sul tamburo: 300 m



CraneSTAR

Sistema di gestione della flotta gru.

Carro



Telaio

Costruzione in sezioni scatolate realizzate in acciaio ad alta resistenza. Casse stabilizzatori rimovibili e agganci anteriori/posteriori per traino, sollevamento e fissaggio.



Stabilizzatori

Quattro stabilizzatori a sfilo singolo ed azionamento idraulico; cilindri verticali a stelo rovesciato con valvole di blocco integrali. Tre configurazioni di lavoro: 0%, 50% e completamente estesi. Casse degli stabilizzatori rimovibili per agevolare il trasporto. Costruzione completamente in acciaio, piatti stabilizzatori a rilascio rapido, diametro 775 mm. Carico massimo piatti stabilizzatori: 75 300 kg. Comandi e indicatore di livello della gru situati all'interno della cabina.



Motore

Tier 3 / Euromot 3A: Diesel Cummins QSB da 8,3 l, 6 cilindri, 224 kW (lordi) a 2200 giri al minuto. Coppia max : 1356 Nm a 1400 giri al minuto. Nota: richiesto per vendita al di fuori dei paesi del Nord America e dell'Unione Europea.

Tier 4f / Euromot 4: Cummins QSL 8,3 L diesel, sei cilindri, sovralimentato con turbocompressore, con sistema di post-trattamento costituito dal filtro antiparticolato Cummins DPF, 239 kW a 2200 giri/min. Coppia massima: 1383 Nm a 1500 giri/min. Conforme ai requisiti richiesti per le emissioni secondo E.P.A. (United States) Tier IV e EUROMOT (Comunità Europea) Stadio 3B. Carburante richiesto: diesel con contenuto massimo di zolfo 15 ppm (Ultra Low Diesel Fuel). Nota: il motore Tier IV / Euromot 3B è richiesto nei paesi del Nord America e dell'Unione Europea.

Capacità serbatoio: 379 l



Cambio

Cambio a 6 rapporti (3 marce x 2 velocità) 6 avanti e 3 retromarcia. Possibilità di esclusione assale anteriore per marcia 4 x 2.



Trazione/Sterzo

4 x 4. Idroguida completamente indipendente:

Anteriore : completamente idraulico azionato tramite il volante.

Posteriore : completamente idraulico azionato con interruttore.

Fornisce 4 modalità di sterzata: solo anteriore, solo posteriore, a granchio e combinata. Indicatore di allineamento delle ruote posteriori.

Raggio di sterzo : 9,7 m.



Assali

Anteriore : Montato rigido sul telaio, trazione con differenziale e mozzi di riduzione planetaria.

Posteriore : Su culla oscillante, trazione con differenziale e mozzi di riduzione planetaria montati.



Pneumatici

Standard 33,25 x 29 – 38 strati trasversali.



Freni

Doppio circuito completamente idraulico agente su tutte le ruote.

Freno di stazionamento negativo ad azionamento idraulico agente sull'asse anteriore.



Luci

Illuminazione completa compresi indicatori di direzione, luci anteriori, posteriori, freno e luci di segnalazione pericolo.



Velocità massima

24 km/h.



Pendenza (teorica)

70% calcolato su peso lordo di 87.751 kg, pneumatici 33,25 x 29, falcone ripiegabile meccanico da 11,0-18,0 m, contrappeso da 17 690 kg, bozzello da 90 t e gancio a palla da 9,0 t.



Impianto elettrico

4 batterie da 12 V. Interruttori di circuito avviamento e illuminazione da 24 V. Sistema di diagnostica CanBus.

* Equipaggiamenti opzionali

• Pacchetto luci ausiliario: comprende luce gialla lampeggiante montata su cabina, barra luminosa LMI in cabina e riflettori doppi montati sul braccio di base, tappetino in gomma per vano di stivaggio • Contrappeso addizionale per sollevamenti pesanti • Registratore eventi ECOS • Anemometro cablato • Gancio di rimorchio posteriore • Luce di segnalazione aerei sul braccio • Pacchetto per climi freddi (-28°C) • Jib doppio ripieghevole idraulico • Jib doppio ripieghevole idraulico con falconcino per impieghi pesanti integrato • Sezioni intermedie • Marchio CE di conformità

*Indica attrezzature opzionali

Superestrutura



Lança

Lança de 12,9 m – 60 m, de seis secções, tipo Megaform™, com sistema de encavilhamento Twin-lock™. Altura máxima à ponta: 63,7 m. Oito roldanas de nylon montadas em rolos cónicos de alta resistência com protectores de cabo removíveis do tipo cavilha. Cabeça de lança de fixação rápida.



Extensão dupla articulada

Extensão dupla articulada de 11,0 m - 18,0 m, dobrável lateralmente. Angulável manualmente a 0°, 20° e 40°. Pode ser arrumada ao longo da secção de base da lança. Altura máxima à ponta: 81,4 m.



* Extensão dupla articulada hidráulica

Extensão dupla articulada de 11,0 m - 18,0 m, dobrável lateralmente. Angulável hidráulicamente de 0° a 40°. Pode ser arrumada ao longo da secção de base da lança. Altura máxima à ponta: 81,4 m.



* Extensão dupla articulada hidráulica com jib de cargas pesadas integrado

Extensão dupla articulada de 11,0 m - 18,0 m com jib de cargas pesadas de 3,6 m com 3 roldanas integrado. Angulável hidráulicamente a 0°, 20° e 40°. Pode ser arrumada ao longo da secção de base da lança. Altura máxima à ponta: 81,4 m.



*Inserções de lança treliçadas

Secções adicionais de lança treliçadas: 1x 8 m e 1 x 6 m. Montam-se entre a ponta da lança telescópica e a extensão dupla articulada. Altura máxima à ponta: 95,3 m.



Elevação da lança

Um cilindro hidráulico de acção dupla com válvula anti-retorno integral assegura a elevação de -3° a +78°.



Sistema de momento de carga e fim de curso do cadernal

“Indicador gráfico” standard do momento de carga e do sistema de fim de curso do cadernal com sistema audiovisual de sinalização e dispositivo de bloqueio automático das alavancas de comando. Estes sistemas fornecem informações, apresentadas em visor electrónico, do ângulo da lança, do comprimento, do raio, da altura da ponta da lança, do momento de carga relativo, da carga máxima admitida, da indicação de carga e aviso sobre o fim de curso do cadernal. O Sistema de Definição da Área de Trabalho standard permite ao operador seleccionar previamente e definir áreas de trabalho. Se a grua se estiver a aproximar dos limites previamente definidos, avisos audiovisuais ajudam o operador a evitar obstruções no local da obra.



Cabine

Cabine panorâmica, integralmente feita de aço, com isolamento sonoro e vidro de segurança colorido a toda a volta. Cabine inclinável até +20 graus. O assento Deluxe integra controladores de eixo duplo, eléctricos, instalados no apoio para os braços. O painel de controlo está equipado com manómetros para todas as funções do motor. Entre as demais funcionalidades standard incluem-se: Volante inclinável, aquecedor da cabine de água quente, ventoinha de circulação do ar na cabine, janelas lateral e traseira deslizantes, vidro de tejadilho deslizante com limpa-vidros eléctrico e pala para o sol, lava e limpa pára-brisas eléctricos, extintor de incêndios e cinto de segurança. Ar condicionado.



Rotação

Accionamento da rotação de planetários de duas velocidades com travão em banho de óleo tipo multidisco de aplicação com o pé. Travão de imobilização de mola e de libertação hidráulica. Bloqueio de rotação positiva de 360° e dispositivo de bloqueio mecânico de duas posições, ambos accionados a partir da cabina. Velocidade máxima : 1,5 rpm.



Contrapeso

17 690 kg. instalados e removidos hidráulicamente. *Contrapeso adicional de 10886 kg (Total 28577 kg) instalados e removidos hidráulicamente



Sistema hidráulico

Quatro bombas principais com uma capacidade combinada de 545 LPM. Pressão de serviço máxima: 275,7 bar. Três válvulas de controlo direccionais primárias com secções de funcionamento independentes. Filtro no circuito de retorno com protecção por derivação de débito total e indicador de manutenção. Cartucho substituível com classe de filtragem micrométrica de 10/12/5. Depósito hidráulico de 655 l. Tomadas para testes de pressão do sistema.



Guincho

Redutor de planetários com travão em banho de óleo multidiscos de mola, automático. Indicadores electrónicos de rotação de tambor de elevação e acamador de cabo no tambor de elevação. Indicador de 5ª volta com função de corte.

Esforço máximo no cabo singelo:
 • Primeira camada: 10707 kg • Terceira camada: 9280 kg • Quinta camada: 7852 kg.
 Esforço máximo admitido no cabo singelo: 7170 kg com cabo da classe 35x7
 Velocidade máxima do cabo singelo: 135 m/min.
 Tipo de Cabo: 35x7 Flex-X resistente à rotação. Diâmetro do Cabo: 19 mm.
 Comprimento do cabo: Guincho principal e auxiliar: 225 m.
 Capacidade Máxima do Cabo: Guincho principal e auxiliar : 300 m.



CraneSTAR

Sistema de gestão de frotas de gruas.
 RT9150E

Chassis



Chassis

Estrutura do chassis tipo caixa fabricado em aço de alta resistência. Caixas dos estabilizadores dianteiros e traseiros removíveis, engates para reboque dianteiro e traseiro e olhas para elevação.



Estabilizadores

Quatro vigas de estabilização hidráulicas e telescópicas, de caixa dupla, de secção simples, com macacos invertidos e válvulas anti-retorno integrais. Três posições : 0%, 50% e totalmente estendidas. Caixas do estabilizador amovíveis para facilitar o transporte. Todos os estabilizadores de remoção rápida fabricados em aço, diâmetro de 775 mm. Carga máxima dos estabilizadores: 75 300 kg. Controlos e indicador de nível da grua localizados na cabina.



Motor

Tier 3 / Euromot 3A: Cummins QSB 8,3 L diesel, seis cilindros, turboalimentado, 224 KW a 2200 rpm. Binário máximo: 1356 Nm a 1400 rpm. Nota: Necessário para venda nos países fora da América do Norte e da União Europeia

Tier 4f / Euromot 4: Cummins QSL 8,3 L diesel, seis cilindros, turboalimentado, com silenciador/filtro de partículas diesel Cummins. Respeita os níveis de emissões de acordo com Tier IV da U.S.E.P.A. e classe IIIB da U.E. 239 KW a 2200 rpm. Binário máximo: 1383 Nm a 1500 rpm. Requisitos relativos ao combustível: máximo de 15 ppm de teor de enxofre (diesel de muito baixo teor em enxofre). Nota: o motor Tier IV é necessário para venda nos países da América do Norte e da União Europeia. Depósito de 379 l.



Transmissão

Transmissão automática 6 x 3 velocidades (3 velocidades x 2 gamas), 6 velocidades de marcha à frente e 3 velocidades de marcha. Desembaixagem do eixo frontal para deslocação 4 x 2.



Tracção/direcção

4 x 4.

Direcção assistida de comando independente:

À frente : totalmente hidráulica, comandada pelo volante.

Atrás : totalmente hidráulica, comandada por interruptor.

Disponibiliza um número infinito de variações dos 4 principais modos

de direcção: só dianteira, só traseira, direcção tipo caranguejo e direcção coordenada.

Indicador de direcção traseira. Raio de viragem : 9,7 m.



Eixos

Dianteiros : Eixo de tracção/direcção com cubos do redutor de planetários e diferencial rigidamente montados no chassis.

Traseiros : Eixo de tracção/direcção com cubos do redutor de planetários e diferencial montados no chassis de forma articulada (pivôs).



Pneus

Pneus standard 33,25 x 29 - 38 telas.



Travões

Travões de disco seco, circuito dividido totalmente hidráulico operando em todas as rodas.

Travão de estacionamento de mola e de libertação hidráulica, montada no eixo dianteiro.



Iluminação

Conjunto completo, incluindo luzes de sinalização de mudança de direcção, faróis dianteiros, faróis traseiros, luzes de travagem e luzes de sinalização de perigo.



Velocidade máxima

24 km/h.



Gradabilidade (teórica)

70% (paragem do motor) baseado em PB 87 751 kg, pneus 33.25 x 29, lança principal de 60,0 m, extensão dupla articulada manual de 11,0-18,0 m, 17 690 kg de contrapeso, gancho de 90 t e gancho de bola de 9,0 t.



Sistema eléctrico

Quatro baterias de 12 V que dispensam manutenção de 12 V. Arranque e luzes de 24 V, disjuntores. Sistema de diagnóstico CanBus.

* Equipamento opcional

• Pacote de iluminação auxiliar (inclui pirilampo rotativo montada na cabine, luz de trabalho montada no guincho, um foco montado no tramo base da lança e protecção em borracha da zona de armazenagem • Conjunto de contrapesos para cargas pesadas • Registo de eventos ECOS • Anemómetro • Gancho de reboque traseiro • Luz de aviso para aviões montada na lança • Pacote para climas frios -28°C (-20°F) • Extensão dupla articulada hidráulica • Extensão dupla articulada hidráulica com jib de cargas pesadas integrado • Inserções de lança treliçadas • Conformidade com a marca CE.

Технические характеристики

Крановая установка



Стрела

12,9-60-метровая, шести-секционная стрела Megaformtm с системой фиксации Twin-lock™. Максимальная длина стрелы: 63,7 м. Восемь ниплатоновых шкивов установлены на подшипниках усиленного конического ролика со съёмными экранами троса шпилечного типа. Наконечник стрелы с быстрым заводом троса



Фиксированный удлинитель стрелы

Складной решетчатый удлинитель стрелы длиной 11,0 / 18,0 м. Возможность установки под углом в 0°, 20° или 40°. Складывается вдоль секции основной стрелы. Максимальная высота оголовка удлинителя: 81,4 м.



*Гидравлическое двухсекционное поворотное удлинение

Складной решетчатый удлинитель стрелы длиной 11,0 / 18,0 м. Гидравлический поворот от 0° до 40°. Складывается вдоль секции основной стрелы. Максимальная высота оголовка удлинителя: 81,4 м.



*Гидравлическое поворотное удлинение со сверхмощной стрелой

11,0-18,0-метровое двухсекционное удлинение с интегрированной 3,6-метровой трехшквовой сверхмощной стрелой. Гидравлический поворот на 0°, 20° и 40°. Укладывает груз со стороны основания секции стрелы. Максимальная высота оголовка удлинителя: 81,4 м.



*Удлинительные решетчатые вставки

1x8 м и 1x6 м удлинительные решетчатые вставки. Устанавливаются между наконечником стрелы и двухсекционным удлинением. Максимальная высота оголовка удлинителя стрелы: 95,3 м.



Угол наклона стрелы

Один гидравлический цилиндр двойного действия со встроенным обратным клапаном обеспечивает подъем от -3° до +78°.



Ограничитель грузового момента и ограничитель высоты подъема крюка

Стандартный ограничитель грузового момента с графическим дисплеем и система блокировки при переподъеме с звуковой и визуальной сигнализацией и блокировкой органов управления. Эти системы выводят на электронный дисплей угол наклона стрелы, длину, радиус, высоту оголовка стрелы, относительный грузовой момент, максимально допустимую нагрузку, текущую нагрузку и предупреждение о возможности перегруза. Стандартная система ограничения рабочей зоны позволяет оператору заранее выбрать и определить безопасные рабочие зоны. При приближении крана к установленным границам срабатывает звуковая и визуальная сигнализация предупреждения оператора.



Кабина

Полностью стальная кабина с круговым обзором, звукоизоляцией и тонированными небьющимися стеклами по всему периметру. Наклон кабины до +20 градусов. Высококачественное сиденье оборудовано встроенными в подлокотники органами управления с одноосевым перемещением. Контрольные приборы для всех рабочих функций выведены на приборную панель. Остальные опции, включенные в стандартную поставку: обогреватель на горячей воде, вентилятор, раздвижные боковые и задние стекла, раздвижная застекленная крыша с электрическим стеклоочистителем и солнцезащитным экраном, электроомыватель и очиститель лобового стекла, огнетушитель и ремень безопасности. Воздушный кондиционер.



Поворот

Двухскоростной привод с планетарным редуктором, охлаждаемый жидкостью тормоз системы управляемый педалью из кабины машиниста. Пружинный гидравлически освобождаемый тормоз механизма, фиксатор поворота, двухпозиционная блокировка поворота крановой установки, оба с управлением из кабины. Максимальная скорость: 1,5 б./мин.



Противовес

17 690 кг. Гидравлическая система монтажа. * Дополнительный вес 10 886 кг (Общий вес 28 577 кг), устанавливается и снимается гидравлически.



Гидравлическая система

Три базисных прямоконтрольных вентиля с секциями независимых функций. Линейный фильтр возвратной магистрали с полнорасходной обводной защитой и сигналом о необходимости технического обслуживания. Заменяемый картридж с микронной фильтрацией в 10/12/5. 655-литровый гидравлический резервуар. Отверстия проверки давления в системе.



Лебедка подъема

Планетарная редукция с автоматическим пружинным мультидисковым влажным тормозом. Электронные индикаторы и следящие элементы барабана подъемной машины и его троса. 5-й датчик натяжки с прерывателем работы. Максимальное натяжение каната при однократной запасовке:
• 1 слой: 10 707 кг. • 3 слой: 9 280 кг. • 5 слой: 7 852 кг.
Максимально допустимое натяжение каната: 7167 кг с устойчивым к скручиванию канатом 35X7
Максимальная скорость каната при однострунной оснастке: 135 м/мин.
Конструкция каната: 35x7 Flex-X, устойчивый к скручиванию. Диаметр каната: 19 мм.
Длина каната: Лебедка основного подъема: 255 м - Лебедка вспомогательного подъема: 255 м.
Максимальная длина укладки каната: 300 м



CraneSTAR

Система управления ресурсом крана.

Тягач



Шасси

Коробчатая рама выполнена из высокопрочной низколегированной стали. Съёмные кожухи выносных опор, передние/задние буксировочные и крепежные проушины.



Выносные опоры

Четыре гидравлические телескопические одноступенчатые двухмуфтовые балочные выносные опоры с перевернутыми цилиндрами и встроенными блокирующими клапанами. 3 позиции выдвижения: 0%, 50% и на полную длину. Блоки выносных опор, съёмные, для упрощения транспортировки. Стальные, легко доступные опорные подушки диаметром 775 мм. Максимальная нагрузка на подушку выносной опоры: 75 300 кг. Органы управления и указатель уровня крана расположены в кабине.



Двигатель

Двигатель (Tier III): Дизельный Cummins QSB 8,3 л, 6-цилиндровый, с турбоагнетателем, мощностью 224 кВт и 2200 оборотов/мин. Максимальный крутящий момент: 1356 Нм при 1400 оборотах/мин. Примечание: Tier III - нормативное требование для продаж вне Европейского Союза и Северной Америки.

Двигатель (Tier IV): Дизельный Cummins QSL 8,3 л, 6-цилиндровый, с турбоагнетателем и выхлопным фильтром/шумоглушителем Cummins Diesel Particulate. Соответствует требованиям U.S.E.P.A. Tier IV и E.U. Stage III B, мощность 239 кВт при 2200 оборотах/мин. Максимальный крутящий момент: 1383 Нм при 1500 оборотах/мин. Требования для горючего: максимальное содержание серы 15 частей на миллион (дизельное топливо с ультранизким содержанием серы) Примечание: двигатель Tier IV - нормативное требование для продаж в Европейском Союзе и Северной Америке.

Емкость топливного бака: 379 л.



Трансмиссия

Система переключения диапазона 6x3-скоростная (3 скорости x 2 диапазона) - 6 передних и 3 задних. Отсоединение передней оси для движения 4x2.



Ведущие/управляемые колеса

4 x 4. Полностью независимое рулевое управление с усилителем:

Передние: С полным гидравлическим усилением. Управление от рулевого колеса. Задние: С полным гидравлическим усилением. Ручное управление с помощью переключателей.

Возможны многочисленные варианты 4 основных режимов рулевого управления: только передние, только задние, crabовый ход и согласованный режим. Индикатор заднего движения. Радиус разворота: 9,7 м.



Оси

Передняя: Ведущая с управляемыми колесами, с дифференциальными и планетарными колесными редукторами, жестко смонтированными на раму. Задняя: Ведущая с управляемыми колесами, с дифференциальными и планетарными колесными редукторами, шарнирно закрепленными на раму.



Шины

Станд. 33,25 x 29 - 38 с диагональным кордом, общего применения.



Тормоза

Контур полного гидравлического разделения, действующий на всех колесах (сухой диск). Пружинный, гидравлически отпускаемый парковочный тормоз, закрепленный на передней оси.



Фары

Полное освещение, включая индикаторы поворота, передние, задние, тормозные фары и лампы аварийной сигнализации.



Максимальная скорость

24 км/ч.



Преодолеваемый уклон (теор.)

70 % (при заглушении двигателя) Базированный на общей массе в 87 751 кг, с шинами 33,25 x 29, 60-метровой главной стрелой, 11,0-18,0-метровым ручным двухсекционным поворотным удлинением, противовесом в 17 690 кг, 90-тонным крюкоблоком и 9-тонной шаровой бабой.



Электросистема

Четыре 12-вольтовых необслуживаемых аккумулятора. 24-вольтовые пусковые и осветительные автоматические выключатели. Система диагностики CanBus.

































* Дополнительное оборудование (по выбору)

• Дополнительный осветительный комплект (состоит из установленного на кабине осветительного фонаря ночного освещения, установленного на подъемнике рабочего освещения, установленных на стреле прожекторов на одиночной основе, а также резиновых коврик). • Мощный противовесный комплект • Регистрирующий самописец ECOS • Постоянный датчик скорости ветра • Задний сцепной крюк • Установленный на стреле сигнал для л аппаратов • Комплект для холодной погоды -28°C (-20°F) • Гидравлический двухсекционный вывод • Гидравлический двухсекционный вывод со сверхмощной стрелой • Удлинительные вставки стрелы • Отметка соответствия стандарту CE

*Дополнительное оборудование

Notes • Hinweise • Notes • Notas • Note • Примечания

Symbols • Symbolerklärung • Glossaire des symboles • Glosario de simbolos • Glossario dei simboli • Simbolos • Символы

	Axles Achsen Ponts Ejes Assali Оси		Counterweight Gegengewicht Contrepoids Contrapeso Contrappeso Противовес		Main hoist Haupthubwerk Treuil principal Cabrestante principal Argano principale Лебедка основного подъема		Outriggers Abstützung Calage Estabilizadores Stabilizzatori Выносные опоры
	Axle load Achslast Charge à l'essieu Carga por eje Carico sugli assi Нагрузка на ось		Crane functions Kranbewegungen Mouvements de la grue Funciones de la grúa Funzioni della gru Функции крана		Auxiliary hoist Hilfshubwerk Treuil auxiliaire Cabrestante auxiliar Argano secondario Лебедка вспомогательного подъема		Radius Ausladung Portée Radio Raggio Вылет
	Boom Ausleger Flèche Pluma Braccio Стрела		Crane travel Fahrstellung Déplacement de la grue Grúa en traslado Traslazione gru Перемещение крана		Hookblock / Capacity Hakenflasche / Traglast Moufle / Force de levage Gancio / Capacità Gancio / Capacità Крюковой блок / Грузоподъемность		Slewing/Working range Drehwerk/Arbeitsbereich Orientation/Rayon d'opération Giro/Gama de trabajo Rotazione/Area di lavoro Поворот/ Рабочий диапазон
	Boom elevation Wippwerk Relevage Elevación de pluma Elevazione braccio Подъем стрелы		Drive/Steer Antrieb/Lenkung Direction/Déplacement Tracción/Dirección Trazione/Sterzo Ведущие/Управляемые оси		Hydraulic system Hydrauliksystem Circuit hydraulique Sistema hidráulico Impianto idraulico Гидравлическая система		Speed Geschwindigkeit Vitesse Velocidad Velocità Скорость
	Boom telescoping Teleskopieren Télescopage de flèche Telescopaje de pluma Lunghezza braccio Выдвижение стрелы		Electrical system Elektrische Anlage Circuit électrique Sistema eléctrico Impianto elettrico Электросистема		Lattice extension Gitterspitze Extension treillis Extensión de celosía Falcone tralicciato Гусек		Suspension Federung Suspension Suspensión Sospensioni Подвеска
	Brakes Bremsen Freins Frenos Freni Тормоза		Engine Motor Moteur Motor Motore Двигатель		Lattice extension (luffing) Gitterspitze (wippbar) Extension treillis (volée variable) Extensión de celosía (angulable hidráulicamente) Falcone tralicciato (inclinabile) Гусек (с изменением вылета)		Transmission / Gear Getriebe / Gang Boîte de vitesses / Rapport Transmisión / Cambio Trasmissione / Cambio Трансмиссия / передача
	Cab Kabine Cabine Cabina Cabina Кабина		Free on wheels Freistehend Sur pneus Sobre neumáticos Su gomme Свободные внутренние колеса		Luffing jib Wippspitzenausleger Volée variable Plumín angulable Falcone a volata variabile Маневровый гусек		Travel speed Fahrtgeschwindigkeit Vitesse de déplacement Velocidad de desplazamiento Velocità di traslazione Скорость движения
	Carrier frame Chassis-Rahmen Châssis porteur Bastidor Telaio Рама тягача		Gradeability Steigfähigkeit Aptitude en pente Superación de pendientes Pendenza superabile Преодолеваемый уклон		Low range Kriechgang Gamme basse Marchas cortas Fuoristrada Низкий диапазон		Tyres Bereifung Pneumatiques Neumáticos Pneumatici Шины

Manitowoc Cranes

Regional headquarters

Americas

Manitowoc, Wisconsin, USA

Tel: +1 920 684 6621

Fax: +1 920 683 6277

Shady Grove, Pennsylvania, USA

Tel: +1 717 597 8121

Fax: +1 717 597 4062

Europe, Middle East, Africa

Dardilly, France

Tel: +33 (0)4 72 18 20 20

Fax: +33 (0)4 72 18 20 00

China

Shanghai, China

Tel: +86 21 6457 0066

Fax: +86 21 6457 4955

Greater Asia-Pacific

Singapore

Tel: +65 6264 1188

Fax: +65 6862 4040

Regional offices

Americas

Brazil

Alphaville

Mexico

Monterrey

Chile

Santiago

Europe, Middle East, Africa

France

Baudemont

Cergy

Decines

Germany

Langenfeld

Italy

Lainate

Netherlands

Breda

Poland

Warsaw

Portugal

Baltar

Russia

Moscow

South Africa

Johannesburg

U.A.E.

Dubai

U.K.

Buckingham

China

Beijing

Chengdu

Guangzhou

Xian

Greater Asia-Pacific

Australia

Brisbane

Melbourne

Sydney

India

Chennai

Delhi

Hyderabad

Pune

Korea

Seoul

Philippines

Makati City

Singapore

Factories

Brazil

Passo Fundo

China

TaiAn

Zhangjiagang

France

Charlieu

Moulins

Germany

Wilhelmshaven

India

Pune

Italy

Niella Tanaro

Portugal

Baltar

Fânzeres

USA

Manitowoc

Port Washington

Shady Grove

This document is non-contractual. Constant improvement and engineering progress make it necessary that we reserve the right to make specification, equipment, and price changes without notice. Illustrations shown may include optional equipment and accessories and may not include all standard equipment.

Die Angaben in diesem Dokument erfolgen ohne Gewähr. Wir verbessern unsere Produkte ständig und integrieren den technischen Fortschritt. Aus diesem Grund behalten wir uns das Recht vor, die technischen Daten, die Ausstattungsdetails und die Preise unserer Maschinen ohne Vorankündigung zu ändern.

Ce document est non-contractuel. Du fait de sa politique d'amélioration constante de ses produits liée au progrès technique, la Société se réserve le droit de procéder sans préavis à des changements de spécifications, d'équipement ou de prix. Les illustrations peuvent comporter des équipements ou accessoires optionnels ou ne pas comporter des équipements standards.

Este documento no es contractual. El perfeccionamiento constante y el avance tecnológico hacen necesario que la empresa se reserve el derecho de efectuar cambios en las especificaciones, equipo y precios sin previo aviso. En las ilustraciones se puede incluir equipo y accesorios opcionales y es posible que no se muestre el equipo normal.

Documento non contrattuale. In considerazione della sua politica di costante miglioramento dei prodotti connesso al progresso tecnico, la Società si riserva il diritto di modificare senza preavviso specifiche, equipaggiamenti o prezzi. Le illustrazioni possono contenere equipaggiamenti o accessori optional o non contenere equipaggiamenti standard.

Este documento não se reveste de qualquer carácter contratual. A introdução constante de melhorias e o progresso da engenharia tornam necessário reservarmos o direito de introduzir alterações nas características técnicas, no equipamento e no preço sem qualquer aviso prévio. As ilustrações aqui apresentadas podem incluir equipamento e acessórios adicionais, podendo não incluir todo o equipamento padrão.

Данный документ не является контрактным. Принимая во внимание необходимость постоянного совершенствования и модернизации мы оставляем за собой право изменять спецификации, конструкции и стоимость без предварительного уведомления. Приведенные иллюстрации могут содержать дополнительные компоненты и принадлежности, не входящие в стандартный комплект поставки оборудования.