



SANY

Quality Changes the World



SANY CRAWLER CRANE SCC 8100

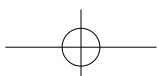



CRAWLER CRANE

CONTENT

P3

SCC8100 Crawler Crane

Outline Dimensions

Technical Features

Main Performance Parameters

Transport Dimensions

Transport Trailer Load Out Summary

Self-assembly Diagram Of Basic Machine

P17

Specifications

Uperworks

Undercarriage

Operation Device

Safety Device

P24

Operating Condition Combination

Operating Condition Combination

H Operating Condition

FJ Operating Condition

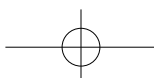
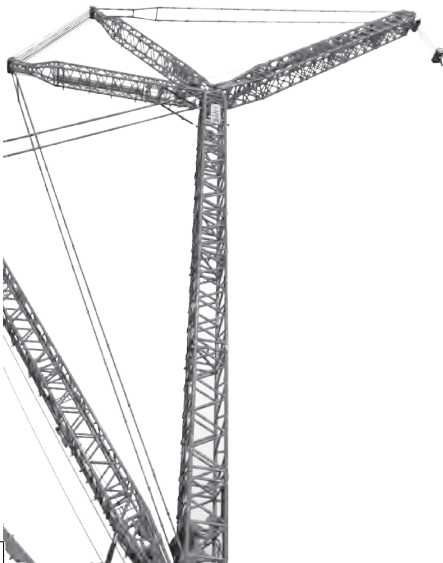

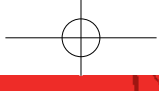

SCC8100

04	Outline Dimensions
06	Technical Features
07	Main Performance Parameters
08	Transport Dimensions
12	Transport Trailer Load Out Summary
14	Self-assembly Diagram Of Basic Machine

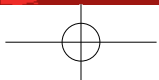



OUTLINE DIMENSIONS

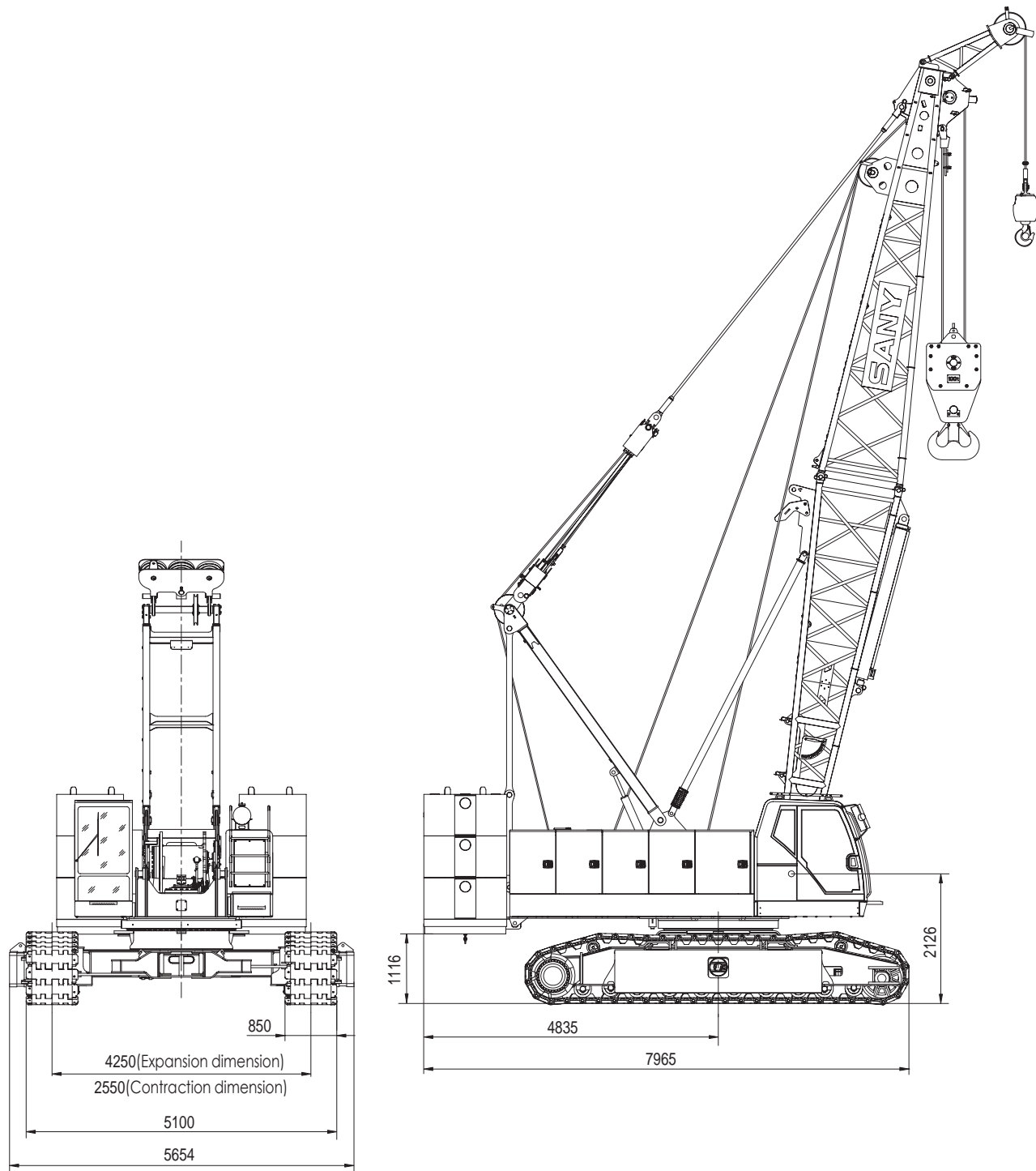



OUTLINE DIMENSIONS

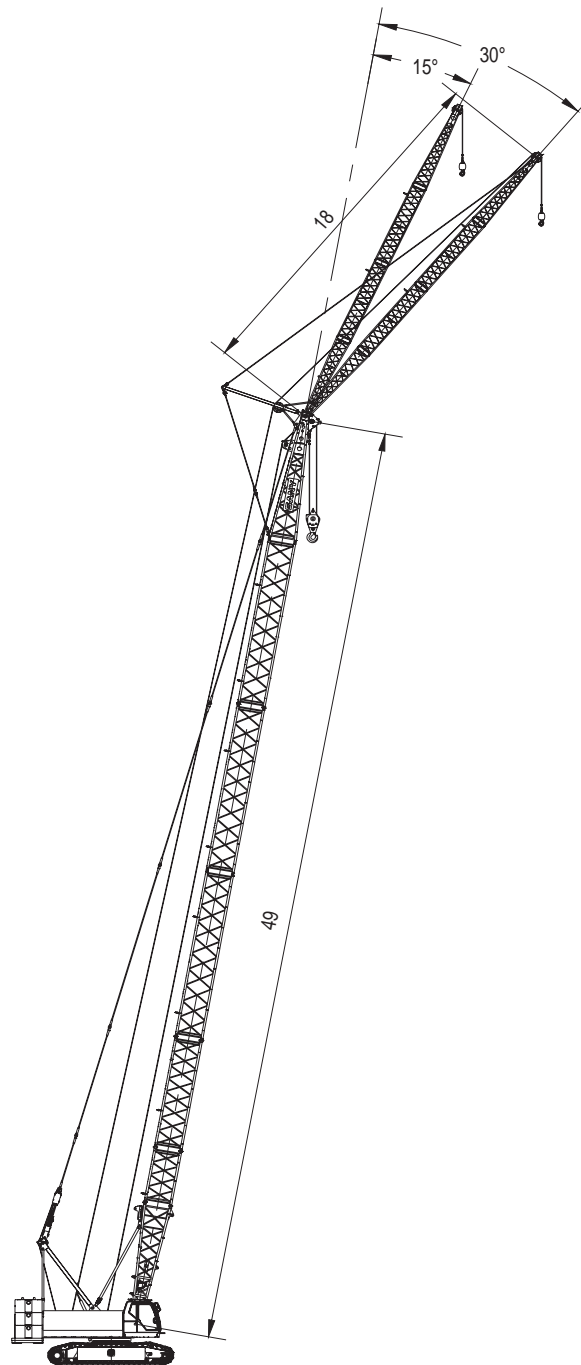

Boom + Fixed jib — FJ operating conditions
(49m boom + 18m fixed jib)

TECHNICAL FEATURES

1. Safety control system:

Two convenient and reliable modes of operation; working and installation, with real-time level display, stop operation braking away from machine, electrical emergency control, anti-lightning protection, automatically walk switches, CCTV monitoring function, complete safety and supervision system;

2. Excellent operating performance:

Load-sensing, limit load regulation and electro-hydraulic proportional micro-speed control make each micro-movement extremely good and operation more stable;

3. Reliable function assurance:

Key components adopt famous international brands; sufficient safety margin for structural and mechanical design; control system can operate stably in harsh environments such as cold, high temperature, altitude and sandy conditions;

4. Convenient maintenance technology:

It takes approximately no more than 10min/person to adjust;no more than 30min/person for daily maintenance;no more than 2h/person to repair.GPS remote monitoring system is optional for maintenance and management;

5. Powerful lifting capacity:

The maximum lifting capacity of boom is $100t \times 3.8m = 380t \cdot m$; the length of longest boom is 67m and of longest boom + jib is 49m + 18m; the rated single line pull of main and auxiliary hoisting winches is very strong;

6. Flexible configuration combination:

The boom winch with free fall or the boom and jib winches with free fall can be optional;

7. Large chassis design:

The track frame can be extended, to ensure the excellent whole machine and operation stability within the 360° rotation;

8. Optimized transportation programs:

With crawler telescopic functions, the maximum transport width of the whole machine is 3.45m, it can transport with the overall track frame;

9. Reliable drive system:

The international famous brand hydraulic technology is used for stable system and higher reliability;

10. Many optional configurations:

The third winch and angle steel boom can be optional.



MAIN PERFORMANCE PARAMETERS

Main performance data of SCC8100 crawler crane

Technical performance index		Unit	Data
Boom operating condition(H)	Max. rated lifting capacity	t	100
	Maximum lifting torque	t•m	380
	Boom length	m	67
	Boom luffing angle	°	20-80
Fixed jib operating condition (optional)	Max. rated lifting capacity	t	8.5
	Fixed jib length	m	18
	Boom luffing angle	°	30~80
	Angle between fixed jib and boom	°	15/30
Operating speed	Main hoisting	m/min	0~130
	Boom luffing line speed	m/min	73
	Swinging speed	rpm	2.92
	Traveling speed	km/h	0~2
	Gradeability	%	30
Transport data	Engine type	-	QSC 8.3
	Output power / Engine speed	kW/rpm	183/2000
	Whole machine weight	t	88
	Counterweight	t	27.4+10
	Max. transport weight of single piece	t	45
Basic machine transport dimension (L×B×H)		m	13.23×3.45×3.49

TRANSPORT DIMENSIONS

Basic machine (with track frame)	×1
Length	13.23m
Width	3.45m
Height	3.49m
Weight	45t
Basic machine (without track frame)	×1
Length	7.97m
Width	3.36m
Height	3.05m
Weight	26t
Track frame	×2
Length	6.29m
Width	1.09m
Height	1.20m
Weight	9.5t
Boom base NO.1513A	×1
Length (L)	6.73m
Width (W)	1.61m
Height (H)	2.18m
Weight	1.69t
Boom tip NO.1513A	×1
Length (L)	7.11m
Width (W)	1.61m
Height (H)	1.76m
Weight	1.47t
3m boom insert NO.1513A	×1
Length (L)	3.14m
Width (W)	1.61m
Height (H)	1.64m
Weight	0.46t

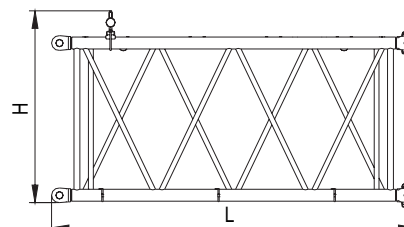
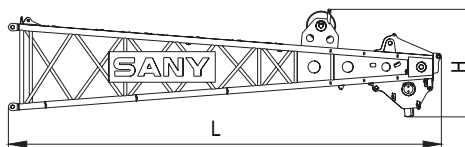
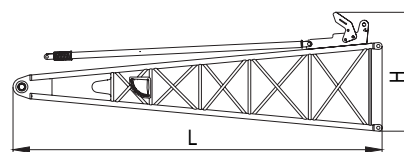
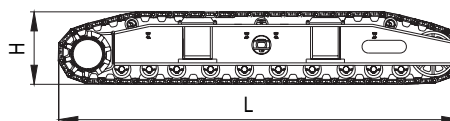
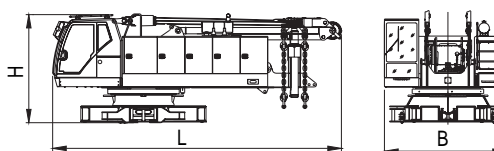
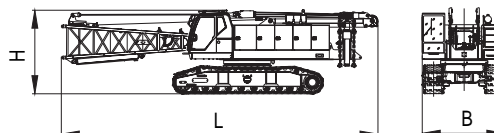



TRANSPORT DIMENSIONS

6m boom insert NO.1513A	×1
Length (L)	6.14m
Width (W)	1.61m
Height (H)	1.64m
Weight	0.74t
9m boom insert I NO.1513A	×5
Length (L)	9.14m
Width (W)	1.61m
Height (H)	1.64m
Weight	0.94t
9m boom insert II NO.1513A	×1
Length (L)	9.14m
Width (W)	1.61m
Height (H)	1.64m
Weight	0.94t
Jib tip NO.0807A	×1
Length (L)	4.875m
Width (W)	0.87m
Height (H)	0.77m
Weight	0.33t
Jib base NO.0807A	×1
Length (L)	4.73m
Width (W)	0.89m
Height (H)	0.77m
Weight	0.3t
4.5m jib insert NO.0807A	×2
Length (L)	4.57m
Width (W)	0.87m
Height (H)	0.77m
Weight	0.23t
Jib extension	×1
Length (L)	1.89m
Width (W)	0.74m
Height (H)	0.64m
Weight	0.17t

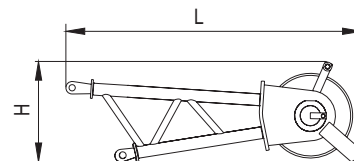
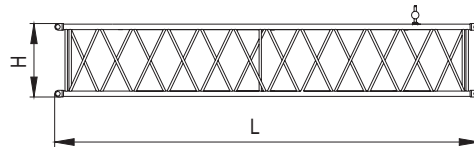
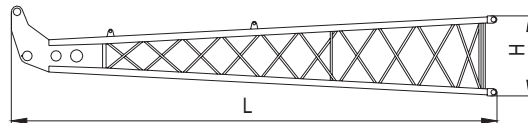
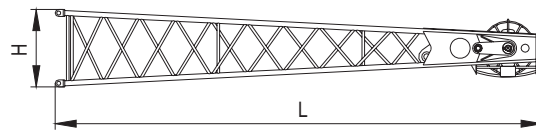
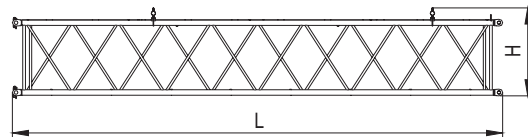
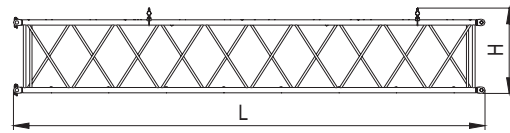
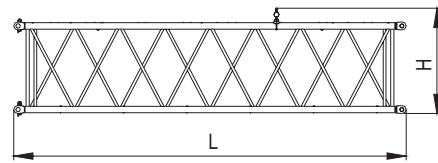

TRANSPORT DIMENSIONS

Central counterweight	×1
Length (L)	3.79m
Width (W)	0.39m
Height (H)	0.73m
Weight	5t
Counterweight tray	×1
Length (L)	4.3m
Width (W)	1.59m
Height (H)	0.62m
Weight	10t
Counterweight block	×6
Length (L)	1.36m
Width (W)	1.09m
Height (H)	0.80m
Weight	2.9t
100t lifting hook	×1
Length (L)	2.24m
Width (W)	0.89m
Height (H)	0.84m
Weight	2.43t
80t lifting hook	×2
Length (L)	2.1m
Width (W)	0.85m
Height (H)	0.75m
Weight	1.45t

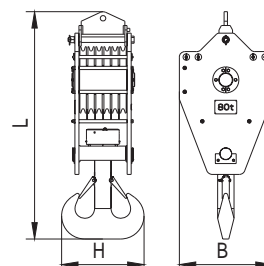
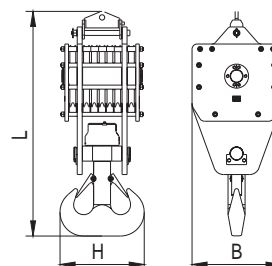
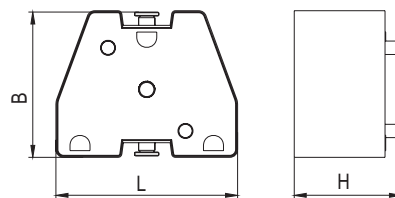
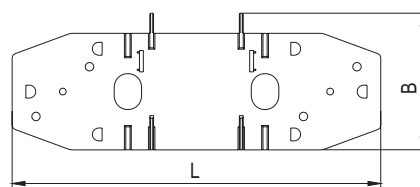
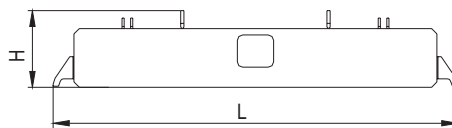



TRANSPORT DIMENSIONS

50t lifting hook	×1
Length (L)	3.79m
Width (W)	0.39m
Height (H)	0.73m
Weight	1t
25t lifting hook	×1
Length (L)	1.79m
Width (W)	0.89m
Height (H)	0.36m
Weight	0.56t
9t Ball hook	×1
Length (L)	0.93m
Width (W)	0.36m
Height (H)	0.36m
Weight	0.34t

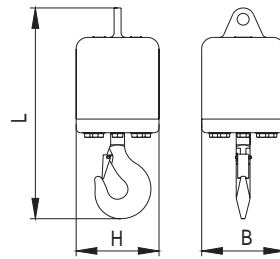
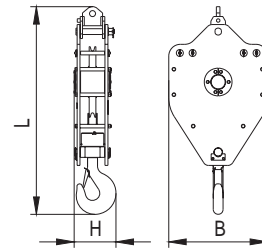
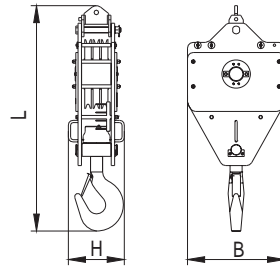

Notes:1.The transport dimensions of the parts marked on schematic diagrams, but not drawn to scale; the dimensions indicated are the design values excluding package.

2.The weight is a design value and may be slightly different due to manufacturing error.

TRANSPORT TRAILER LOAD OUT SUMMARY

Transport Trailer Load out Summary (with track frame)						
Name	Weight (t)	1	2	3	4	5
Basic machine (with track frame)	45	1				
Rear counterweight tray	10		1			
Central ballast	5		1			1
Counterweight block	2.9			2	2	2
Boom tip	1.47		1			
3m boom insert	0.46					1
6m boom insert	0.74					1
9m boom insert	0.94			2	2	1
Fixed jib tip	0.33			1		
Fixed jib base	0.3				1	
4.5m fixed jib	0.23			2		
Jib extension	0.17				1	
100t lifting hook	2.43			1		
80t lifting hook	1.45				1	
50t lifting hook	1				1	
25t lifting hook	0.56				1	
9t ball hook	0.34			1		
Weight Each Trailer (t)		45	16.47	10.91	11.16	12.94



TRANSPORT TRAILER LOAD OUT SUMMARY

Transport Trailer Load out Summary (without track frame)							
Name	Weight (t)	1	2	3	4	5	6
Body (without track frame)	26	1					
Track frame	9.5						2
Boom base	1.69						1
Rear counterweight tray	10		1				
Central ballast	5		1			1	
Counterweight block	2.9			2	2	2	
Boom tip	1.47		1				
3m boom insert	0.46					1	
6m boom insert	0.74					1	
9m boom insert	0.94			2	2	1	
Fixed jib tip	0.33			1			
Fixed jib base	0.3				1		
4.5m fixed jib	0.23			2			
Jib extension	0.17				1		
100t lifting hook	2.43			1			
80t lifting hook	1.45				1		
50t lifting hook	1				1		
25t lifting hook	0.56				1		
9t bool hook	0.34			1			
Weight Each Trailer (t)		26	16.47	11.24	11.16	12.94	20.69

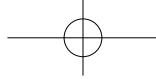

SELF-ASSEMBLY DIAGRAM

1) Self-assembly diagram of basic machine

Way 1 (transportation with track frame); basic machines can walk and do lower works

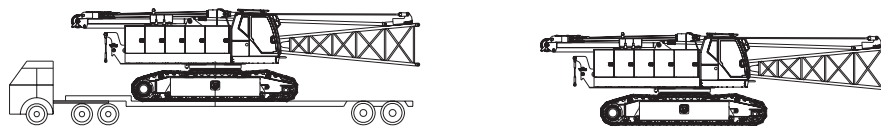

Way 2 (Transportation with the removal of track frame)

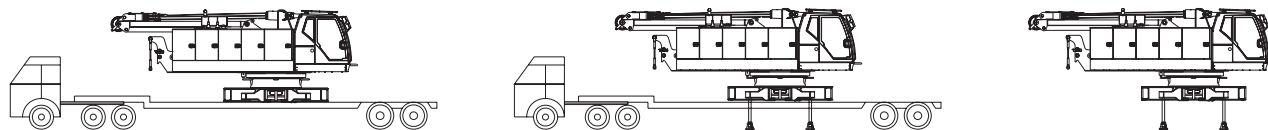

2) Track frame assembly and disassembly

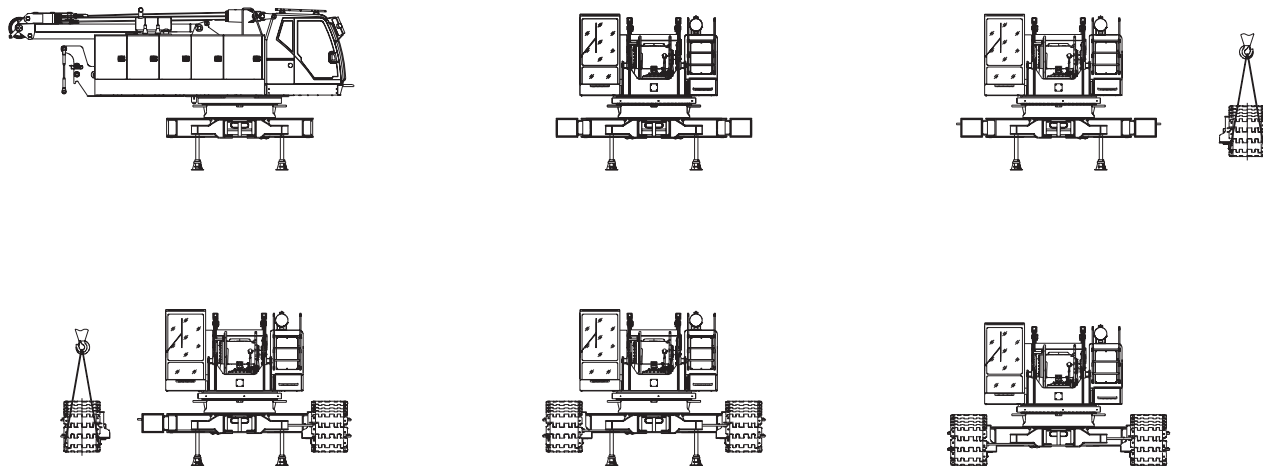

3) Boom base assembly

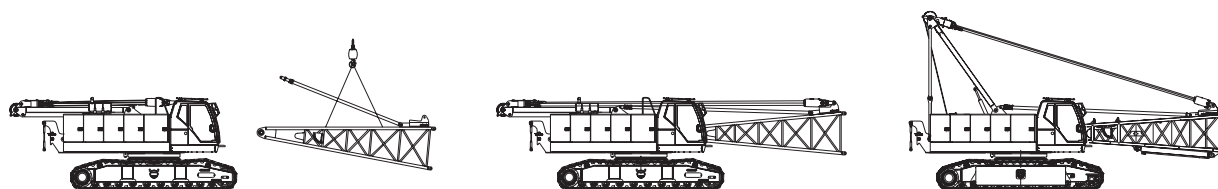

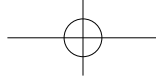

SELF-ASSEMBLY DIAGRAM

4) Central counterweight self-assembly

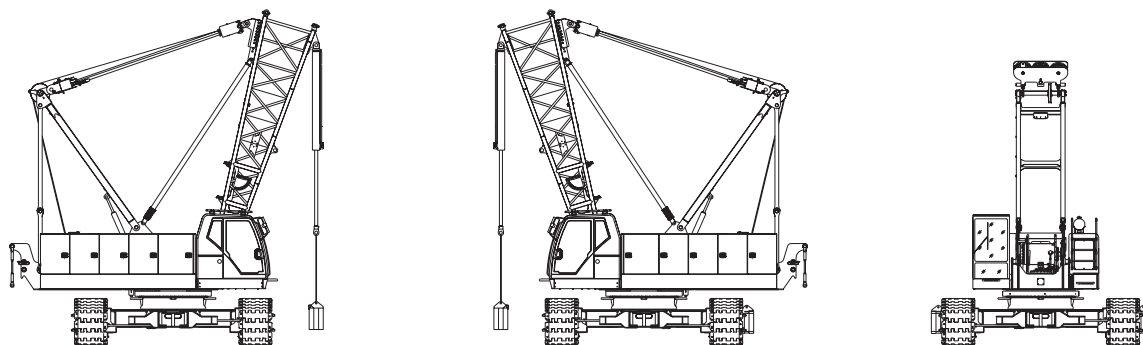

5) Rear counterweight self-assembly

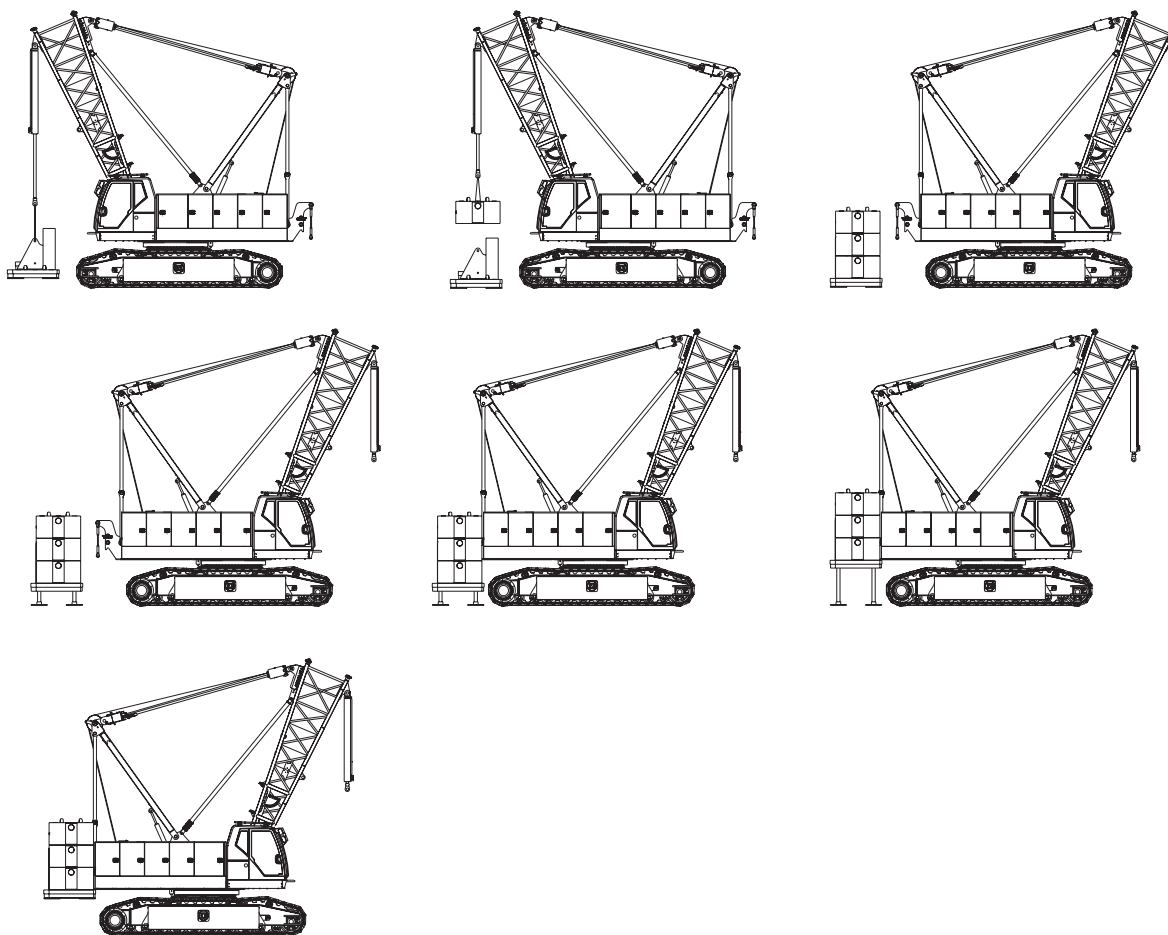



SELF-ASSEMBLY DIAGRAM

6) Boom system assembly diagram

Boom system assembly under boom operating condition

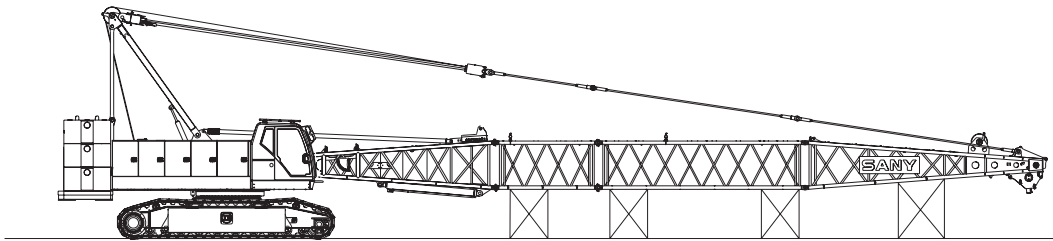
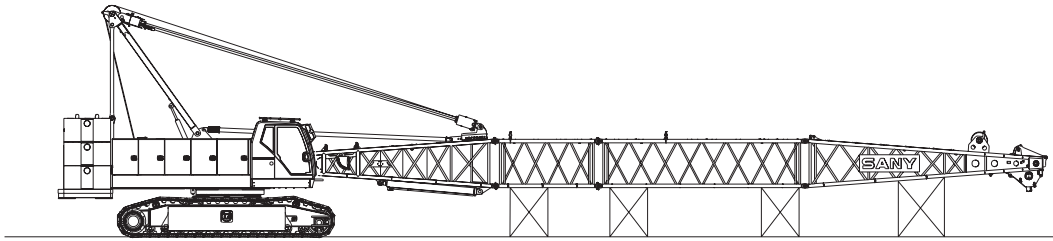
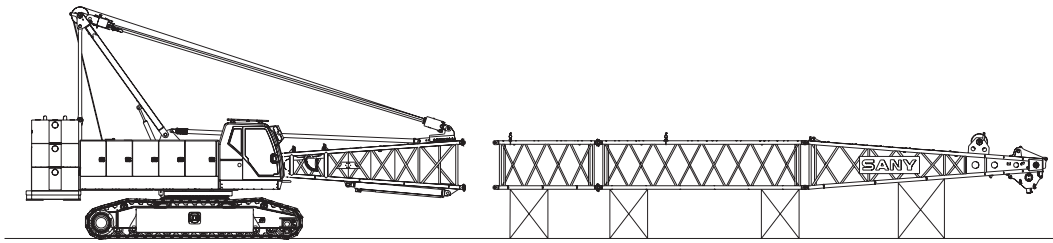

Jib system assembly under jib operating condition

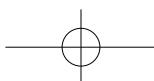
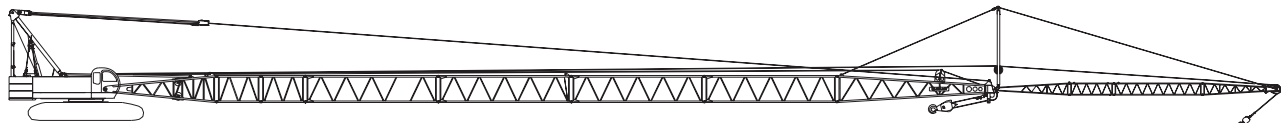
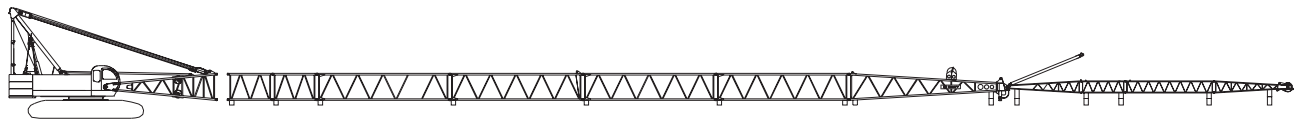

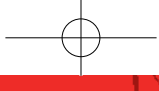

SCC8100

18	Uperworks
20	Lowerworks
21	Operation Device
22	Safety device

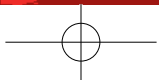

UPERWORKS

1) Engine

- QSC8.3 type imported Cummins.
- Rated power / speed: 183kW/2000rpm.
- Max torque: 1268N·m/1400rpm;
- Emission standard: Tier III.
- Air filter: double filtration system composed of air pre-filter and air filter.
- Fuel tank: Capacity of 400L.

2) Electrical control system

- The CAN bus technology is applied to connect the controller, combined instruments, engine, load moment limiter and remote control terminal for data communication.
- The combined instrument can display the engine speed, fuel level, engine oil pressure, servo pressure, wind speed and engine working time etc. working parameters and the main winch locking, boom luffing locking and slewing locking etc. working state.

3) Hydraulic system

Hydraulic system configuration:

The global famous brand hydraulic system is adopted, including the main pump, main valve, control handle and motor reducer, which is characterized by high efficiency, energy-saving, stability and reliability.

It has the excellent swinging and lifting inching performance, with load sensor and limit load adjustment for smooth operation.

The independently controlled hydraulic cooling system is used.

4) Main and auxiliary hoisting mechanism

- The main and auxiliary winches can be driven respectively. And the drum can be directly driven by the winch motor through the reducer. The rotation of drum to two directions can be achieved through the winch handle. That is the lifting and lowering actions of hook.
- The world-famous brand motor reducer is adopted for higher reliability.
- The main winch with free fall or the main and auxiliary winches with free fall can be optional.
- The fold-line drum is designed to ensure the multi-layer winding without disordered ropes.
- The fold line winding drum design can ensure that multi-layer winding rope without mess.

Main and auxiliary hoisting mechanism

Wire speed of outer operating wires	0~130m/min
Diameter of steel wire	φ24mm
Length of main / auxiliary steel wire	220m/160m
Rated tension of single wire	9.5T

5) Luffing mechanism

- The drum can be directly driven by the luffing motor through the reducer. The drum rotation to two directions can be achieved through the luffing handles, thus achieving the lifting and lowering actions of boom.
- The world-known brand motor reducer is adopted for higher reliability.
- The fold-line drum is designed to ensure the multi-layer winding without disordered ropes.
- The world-know brand wire rope is adopted for higher reliability and durability.



Luffing mechanism

Wire speed of outer operating wires	0~73m/min
Diameter of steel wire	φ20mm
Length of luffing steel wire	140m
Rated tension of single wire	7.0T

6) Swing mechanism

- External gear compound swing can rotate 360° .
- The world-known brand motor reducer is adopted for higher reliability.

7) Swing lock

The hydraulic control automatically locking pin is adopted to ensure that the upper works can be locked reliably after the completion of operation or transportation.

8) Free wheels pin

In hoisting, boom center and load center are not on the same level due to wrong judgment; free wheels pin can automatically arrange upper works to avoid movement of load after being hoisted.

9) Swing ring

The single-row Q series swing ring is adopted.

10) Cab

Newly designed sliding-door cab, large area windows; with near and far beam headlamp, rear-view mirrors and more open vision; Installed with heating and cool air conditioning, MP3 player; seats, control handle; control button layout designed according to ergonomic; thus operation is more comfortable.

- Armrest box: installed, with the manipulation handle, all electrical switches and ignition lock on left, right arm and vice control box. Armrest can be adjusted with the seat.
- Seat: suspension, multi-way adjustable seats with unloading switch.
- Air conditioning: heating and cooling air, optimized air duct and air outlet.

11) Counterweight

The overlapping way for trays and counterweight blocks is adopted for easy combination, disassembly and transportation.

Counterweight: The weight of rear counterweight is 27.4T, including the 10T × 1 tray, 2.9T × 6 counterweight block and 5T × 2 central ballast.

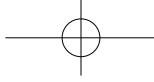

LOWERWORKS

The track frame on both sides adopts separate walk-driven devices. Walking motor can achieve lineal walk and turn of the whole machine through motor reducer and driving wheel.

1) Track telescopic

The track frame expansion and contraction can be achieved through the cylinder.

2) Track tension

use pushing guide wheels of hydraulic jacks; adjust the tension of track by adjusting shims.

3) Track shoe

high-strength alloy steel track link with longer life.

When without transportation weight limits, track frame can be shrunk in transportation. The overall transport of machine with track frame can be achieved. Reduce disassembly time.

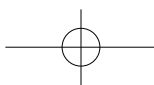
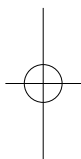
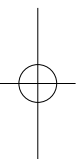



OPERATION EQUIPMENTS

1) Boom

- Truss structures; the main chord adopts high strength structure steel; each section is connected with pins.
- Basic boom: 6.5m boom top and 6.5m boom base.
- Insert: 3m×1, 6m×1, 9m (I) ×5 and 9m (II)×1.
- Boom length: 13m~ 67m.

2) Fixed jib

- Truss structures; the main chord adopts high strength structure steel; each section is connected with pins.
- Basic boom: 4.5m boom top and 4.5m boom base.
- Insert: 4.5m×2.
- Jib length: 9m~18m.
- Longest boom + jib: 49m boom +18 jib.

3) Lifting show

- Standard configuration: 100t lifting hook
- 80t lifting hook
- 50t lifting hook
- 25t lifting hook
- 9t lifting hook

Notes: The above operating devices are safe configuration; order contract shall prevail for specific configuration.

SAFETY DEVICE

1) Switch between installation/operation mode

In installation mode, anti roll device, lifting boom inhibiting device, torque limiter does not work to facilitate crane installation. In operation mode, all the safety limit devices are working.

2) Emergency stop function

In emergency, press the emergency stop button to cut off power supply of the machine and stop all the operations.

3) Emergency function

When the system crashes, use electrical emergency plug and manipulate the machine to a safe status. Then all the security protection functions are not working.

4) Load moment indicator (LMI)

- A completely separate and secure computer-controlled operating system; LMI can automatically detect the load of cranes and the angle of lifting arm and show its rated load and actual load, working radius and boom angle.
- Components: machine, monitor, angle sensors, force sensors etc.
- Functions: can real-time display rated load, actual load, working radius and boom angle, height and other data at current status of the crane. Automatically detect amplitude angle transfinite and load transfinite and other dynamic data, and give real-time alarm and limit movement.

5) Anti-pulley equipments of main and auxiliary winches

Composed of limit switch, hammer etc. on jib to prevent excessive promotion of hook block. When the lifting hook raises to a certain height, limit switch will work, the buzzer on the control panel will alarm, meanwhile the failure indicator blinks and automatically stop the lifting operation of hook block.

6) Anti over-discharge equipments of main and auxiliary hook

It is composed of movement trigger device and proximity switches installed in roll to prevent wire rope from being over-decentralized. When the wire rope is over-decentralized near the last three rounds, limit switch will work, the system will alarm through buzzer, alarm information will be displayed in instrument cluster and automatically stop the decentralization movement of hoist.

7) Function lock

- If the function locking handle is not at the proper position, all other function control handle will fail, to prevent the mis-operation due to body impact when getting on or off the vehicle.
- If the operator does not sit on the seat, all devices will not work, to effectively avoid some error operations.

8) Drum locking device

There are electrically controlled locking devices for main winch, auxiliary winch and luffing winch. Before operating the winch, the action can be done only after the button is turned to the release position, to prevent mis-operation of handle, thus ensuring the parking safety of winch at non-working state.

9) Swing locking device

Primary reel, vice reel and amplitude winch are equipped with electric locking device.

Before winch operation, users need to switch towards dissolution for operation consciously, avoid handle mis-operation; ensure the security of winch under non-working states.



10) A-frame alarm device

In installation mode, if A-frame does not rise to position, then it will transform into work mode; the system will alarm by buzzer and display, meanwhile all motor functions will fail.

11) Boom angle limit device

- If the boom angle is more than 83° , the buzzer will give an alarm and the boom operation will be cut off, with this protection function controlled by the LMI and position switch.
- If the boom angle is less than 20° , the buzzer will give an alarm and the combined instrument display will show the alarm information to automatically stop the lowering action. This protective function is automatically controlled by the LMI.

12) Boom back-stop device

Composed of nesting tube and spring etc. Buffer the energy of boom backwards tilting by spring force to prevent boom backwards tilting.

13) Boom angle indicator sign plate

The pendulum angle indicator device is fixed on the boom base near the cab for convenient view of operator.

14) Hook latch

There is a baffle on the hook to prevent the wire rope fall off.

15) Monitoring system

Camera: There are two cameras to monitor the auxiliary winch, luffing winch and machine rear states.

Optional monitoring: The zoom monitoring system is adopted to monitor the working status of hook.

Optional remote monitoring: The GPS satellite positioning, GPRS data transfer, equipment use state inquires, statistics, running data monitoring and analysis and fault remote diagnosis can be achieved.

16) Lightning protection devices

It includes the lightning ground device and surge protective device, to effectively prevent the damage to the electrical system components and operators when lightning.

17) Level indicator

The electric level indicator is used to show the superstructure tilt angle on the display.

18) Three-color load alarm light

There are green, yellow and red colors for load warning lamp that can show the load in real time simultaneously. If the actual load is less than 92% of rated load, the "Green lamp" will be on; if more than 92% but less than 100%, the "yellow lamp" will be lit and the warning lamp will flash and give a discontinuous alarm; if up to 100%, the "Red lamp" will be on; if more than 102%, the system will automatically cut off the operation of crane to dangerous trend.



19) Audible and visual alarm

When the engine works, the light will flash; when at traveling or slewing operation state, the sound alarm will be given.

20) Swing indicator device

When traveling or slewing, the slewing indicator lamp will flash.

21) Illumination light

The winch lighting lamp, short-beam lamp at the front of cab, front angle adjustable far-beam lamp, lamp in cab and the lighting device at night are equipped to improve the visibility of construction.

22) Rearview mirrors

They are equipped at the right side of cab and on the handrail at the front of hood, to facilitate the monitoring of the whole rear of machine

23) Boom warning light

It is installed on the top of boom for altitude lighting.

24) Seat-leaving protection

If the operator does not sit on the seat, all device will not work, to effectively avoid some mis-operation.

25) Anemometer

It is installed on the top of boom, to monitor the wind speed in real time and transfer the data to the cab and show them on the monitor.

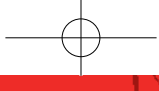

SCC8100

Operating Condition Combination 27

H Operating Condition of Boom 28

FJ Operating Condition of Fixed Jib 32





OPERATING CONDITIONS COMBINATION

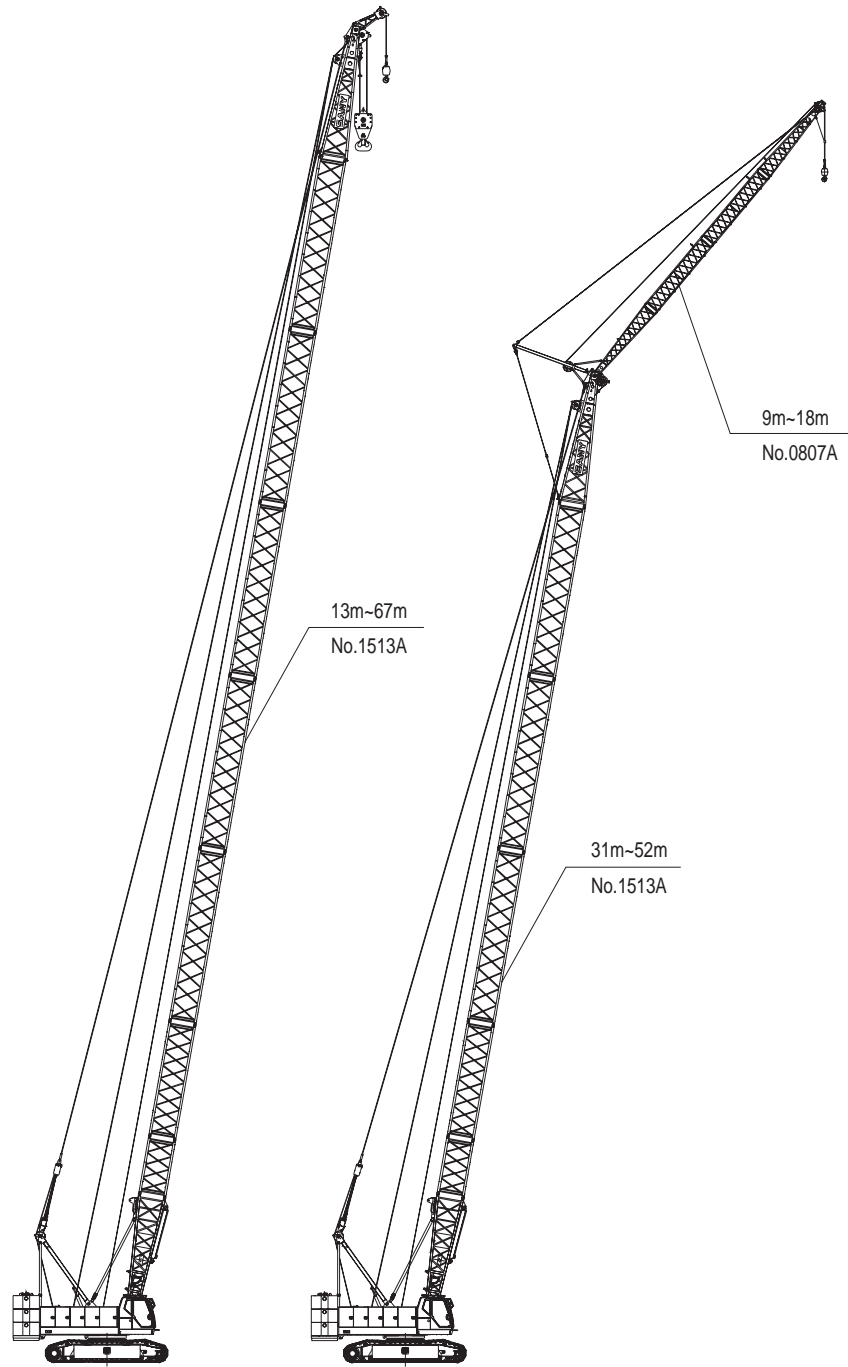

Round steel boom H operating condition
Longest boom: 67m

FJ operation condition
Longest boom + jib: 49m+18m



H OPERATING CONDITION BOOM COMBINATION

Boom length (m)	Insert			
	3	6	9(I)	9(II)
13	-	-	-	-
16	1	-	-	-
19	-	1	-	-
22	-	-	1	-
25	1	-	1	-
28	-	1	1	-
31	1	1	1	-
34	1	-	2	-
37	-	1	2	-
40	1	1	2	-
43	1	-	3	-
46	-	1	3	-
49	1	1	3	-
52	1	-	4	-
55	-	1	4	-
58	1	1	4	-
61	1	-	5	-
64	-	1	4	1
67	1	1	4	1

Notes: 1. There is no mid-point suspension cable connecting seat at the end of connector of 9m (I) insert;
 2. There is mid-point suspension cable connecting seat at the end of connector of 9m (II) insert.

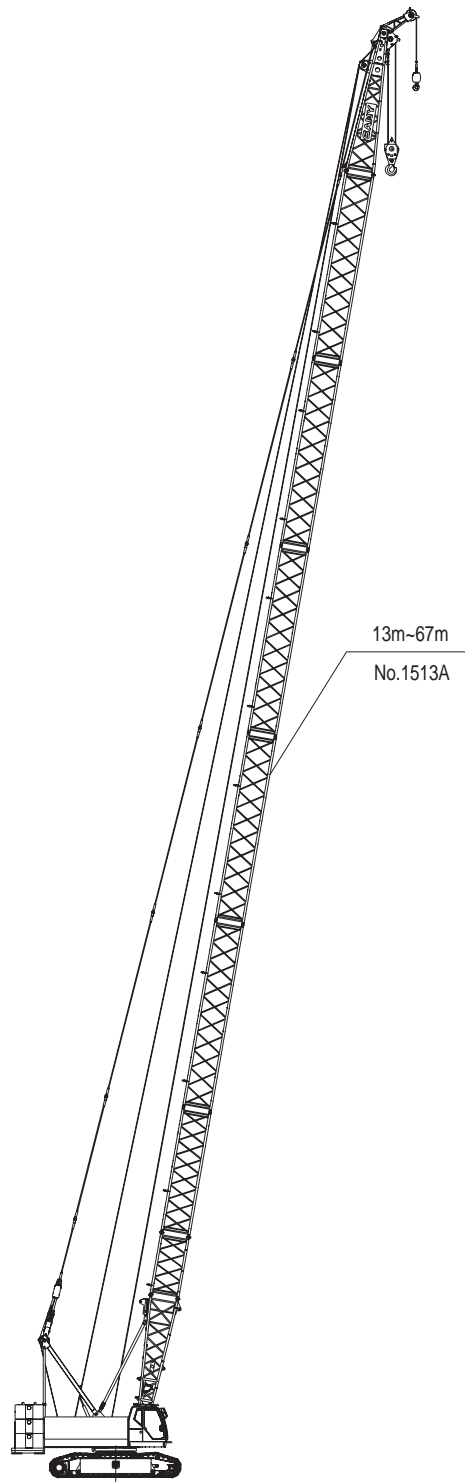



BOOM OPERATION SCOPE

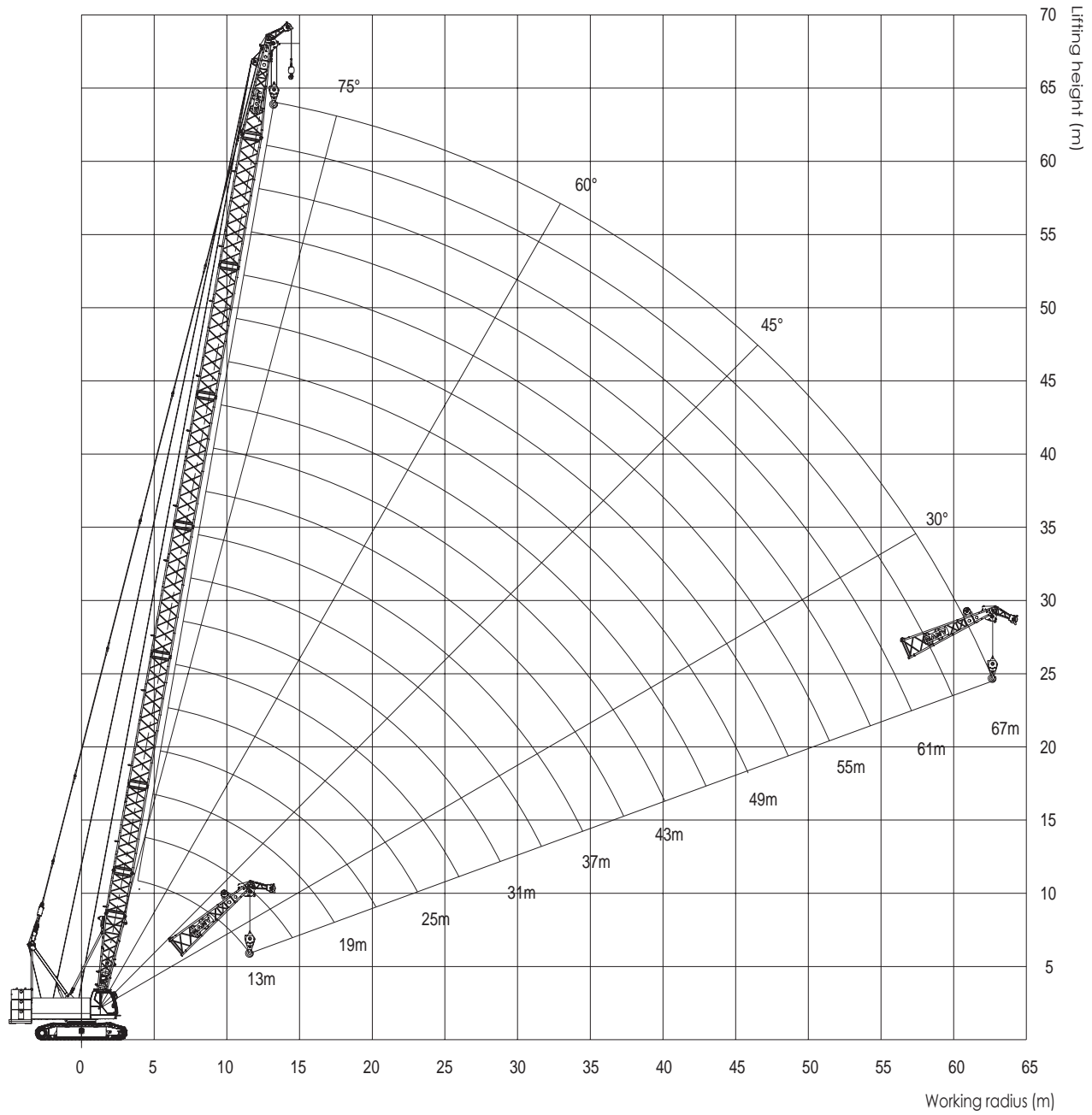

Lifting height working range curve

H OPERATING CONDITION LOAD CHART

SCC8100 H operation condition (series 2) Load Chart BOOM No.1513A

Boom No.1513A 27.4t+10.0t 360°

Unit: (t)

Radius (m)	13	19	25	31	37	43	49	55	61	67	Radius (m)
3.8	100.0	-	-	-	-	-	-	-	-	-	3.8
4.0	90.0	-	-	-	-	-	-	-	-	-	4.0
4.5	80.0	-	-	-	-	-	-	-	-	-	4.5
5.0	75.0	75.0	-	-	-	-	-	-	-	-	5.0
5.5	68.9	67.1	-	-	-	-	-	-	-	-	5.5
6.0	62.5	60.2	60.0	-	-	-	-	-	-	-	6.0
6.5	55.9	54.6	53.5	-	-	-	-	-	-	-	6.5
7.0	50.0	49.3	46.7	46.3	-	-	-	-	-	-	7.0
7.5	45.2	44.6	43.1	41.6	-	-	-	-	-	-	7.5
8.0	41.3	40.7	40.1	38.5	36.2	-	-	-	-	-	8.0
9.0	35.0	34.6	34.1	33.2	32.1	31.1	-	-	-	-	9.0
10.0	30.4	30.0	29.5	29.1	28.4	28.0	-	-	-	-	10.0
11.0	26.8	26.4	26.0	25.6	25.2	24.9	24.6	-	-	-	11.0
12.0	23.9	23.5	23.2	22.8	22.4	21.8	21.4	21.0	-	-	12.0
13.0	21.5	21.2	20.9	20.5	20.2	19.8	19.5	19.2	18.5	-	13.0
14.0	-	19.3	18.9	18.6	18.3	17.9	17.7	17.3	16.8	15.4	14.0
15.0	-	17.6	17.3	17.0	16.6	16.3	16.1	15.7	15.3	14.5	15.0
16.0	-	16.2	15.9	15.6	15.3	14.9	14.6	14.4	14.0	13.3	16.0
18.0	-	13.9	13.6	13.3	13.0	12.7	12.4	12.1	11.8	11.2	18.0
20.0	-	-	11.8	11.7	11.3	10.9	10.6	10.4	10.0	9.6	20.0
22.0	-	-	10.4	10.2	9.9	9.6	9.3	9.0	8.6	8.2	22.0
24.0	-	-	9.2	9.1	8.8	8.4	8.2	7.8	7.4	7.1	24.0
26.0	-	-	-	8.1	7.8	7.5	7.2	6.9	6.5	6.2	26.0
28.0	-	-	-	7.3	6.9	6.6	6.4	6.0	5.7	5.3	28.0
30.0	-	-	-	6.5	6.2	5.9	5.7	5.3	5.0	4.6	30.0
32.0	-	-	-	-	5.6	5.3	5.0	4.7	4.3	4.0	32.0
34.0	-	-	-	-	5.1	4.8	4.5	4.2	3.8	3.5	34.0
36.0	-	-	-	-	4.6	4.3	4.0	3.7	3.3	3.0	36.0
38.0	-	-	-	-	-	3.9	3.6	3.3	2.9	2.6	38.0
40.0	-	-	-	-	-	3.5	3.2	2.9	2.5	2.2	40.0
42.0	-	-	-	-	-	-	2.9	2.6	2.2	1.9	42.0
44.0	-	-	-	-	-	-	2.6	2.2	1.9	1.6	44.0
46.0	-	-	-	-	-	-	2.3	2.0	1.6	1.3	46.0
48.0	-	-	-	-	-	-	-	1.7	1.3	1.0	48.0
50.0	-	-	-	-	-	-	-	1.5	1.1	0.8	50.0
52.0	-	-	-	-	-	-	-	1.2	0.9	-	52.0
54.0	-	-	-	-	-	-	-	-	0.7	-	54.0

- Notes: 1.The actual weight is a value that the rated weight in this table is subtracted by the weights of the hooks, hangers, and wire ropes winding on the hooks and on the boom head.
 2.The rated load in table refers to a value under the condition that the heavy load is lifted slowly and smoothly from the level and hard soil ground.

H OPERATING CONDITION LOAD CHART

SCC8100 H operation condition (series 1) Load Chart BOOM No.1513A

Boom No.1513A 21.6t+0.0t 360°

											Unit: (t)
Radius (m)	13	19	25	31	37	43	46	49	55	58	Radius (m)
3.8	90.0	-	-	-	-	-	-	-	-	-	3.8
4.0	85.0	-	-	-	-	-	-	-	-	-	4.0
4.5	77.6	69.1	-	-	-	-	-	-	-	-	4.5
5.0	65.1	60.4	-	-	-	-	-	-	-	-	5.0
5.5	55.4	53.6	49.1	-	-	-	-	-	-	-	5.5
6.0	48.2	47.4	44.4	-	-	-	-	-	-	-	6.0
6.5	42.5	41.9	40.5	37.7	-	-	-	-	-	-	6.5
7.0	38.1	37.5	36.9	34.7	-	-	-	-	-	-	7.0
7.5	34.4	33.9	33.4	32.2	30.2	-	-	-	-	-	7.5
8.0	31.4	30.9	30.5	30	28.1	26.5	-	-	-	-	8.0
9.0	26.6	26.2	25.8	25.5	24.7	23.3	22.7	-	-	-	9.0
10.0	23.0	22.7	22.4	22	21.7	20.8	20.2	19.7	-	-	10.0
11.0	20.3	20.0	19.7	19.4	19	18.7	18.2	17.7	16.7	16.2	11.0
12.0	18.1	17.8	17.5	17.2	16.9	16.6	16.4	16	15.1	14.7	12.0
13.0	16.3	16.0	15.7	15.5	15.1	14.8	14.7	14.5	13.8	13.3	13.0
14.0	14.8	14.5	14.2	14	13.7	13.4	13.2	13.1	12.6	12.2	14.0
15.0	-	13.2	13.0	12.8	12.5	12.2	12	11.9	11.5	11.2	15.0
16.0	-	12.2	11.9	11.7	11.4	11.1	11	10.8	10.5	10.3	16.0
18.0	-	10.4	10.2	9.9	9.7	9.4	9.2	9.1	8.8	8.7	18.0
20.0	-	9.0	8.8	8.6	8.3	8	7.9	7.8	7.5	7.3	20.0
22.0	-	-	7.7	7.5	7.2	6.9	6.8	6.7	6.4	6.3	22.0
24.0	-	-	6.8	6.6	6.3	6.1	5.9	5.8	5.5	5.4	24.0
26.0	-	-	6.0	5.9	5.6	5.3	5.2	5.1	4.8	4.6	26.0
28.0	-	-	-	5.2	5	4.7	4.6	4.5	4.2	4	28.0
30.0	-	-	-	4.7	4.4	4.1	4	3.9	3.6	3.5	30.0
32.0	-	-	-	4.2	3.9	3.7	3.6	3.4	3.2	3	32.0
34.0	-	-	-	-	3.5	3.3	3.1	3	2.8	2.6	34.0
36.0	-	-	-	-	3.2	2.9	2.8	2.7	2.4	2.2	36.0
38.0	-	-	-	-	2.8	2.6	2.5	2.3	2.1	1.9	38.0
40.0	-	-	-	-	-	2.3	2.2	2.1	1.8	1.6	40.0
42.0	-	-	-	-	-	-	1.9	1.8	1.5	1.3	42.0
44.0	-	-	-	-	-	-	-	1.7	1.6	1.3	44.0
46.0	-	-	-	-	-	-	-	1.4	1.3	1	46.0
48.0	-	-	-	-	-	-	-	-	1.1	0.8	48.0

Notes: 1.The actual weight is a value that the rated weight in this table is subtracted by the weights of the hooks, hangers, and wire ropes winding on the hooks and on the boom head.
 2.The rated load in table refers to a value under the condition that the heavy load is lifted slowly and smoothly from the level and hard soil ground.

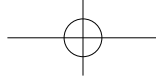

FJ OPERATING CONDITION JIB COMBINATION

Jib length (m)	Insert	Angle between boom and jib
9.0	–	15° , 30°
13.5	1	15° , 30°
18.0	2	15° , 30°
31	1	15° , 30°

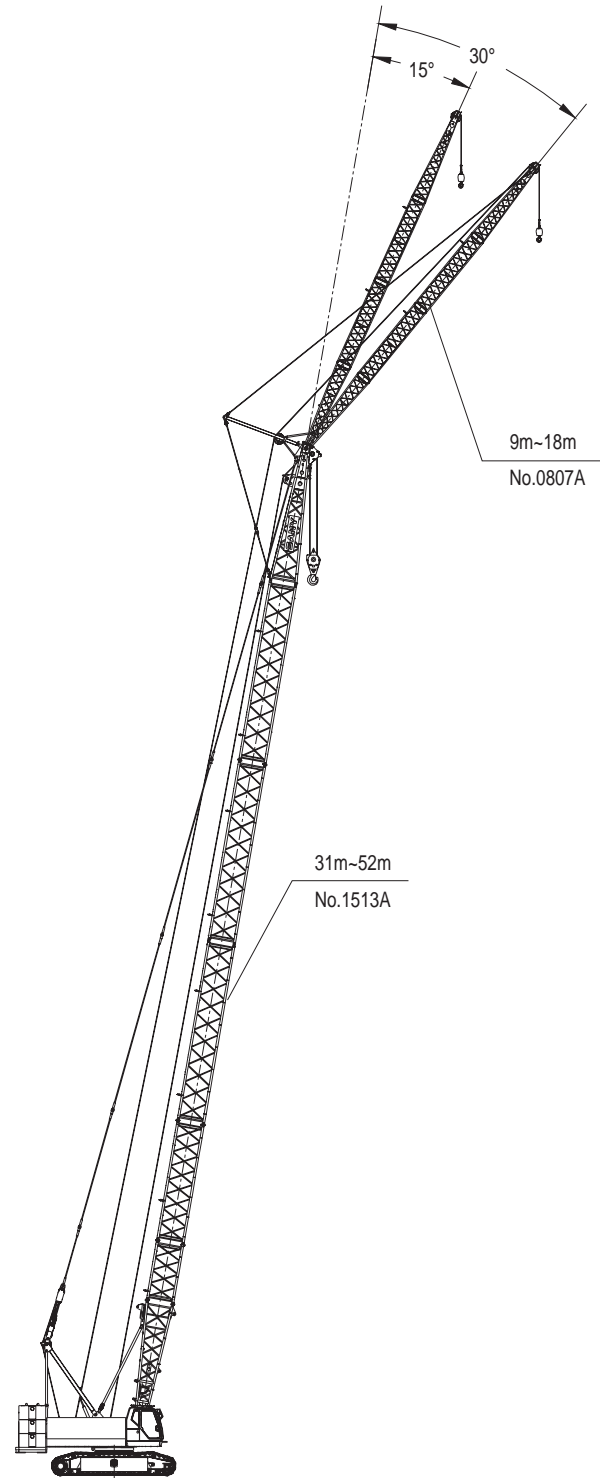



FJ OPERATING CONDITION RANGE DIAGRAM

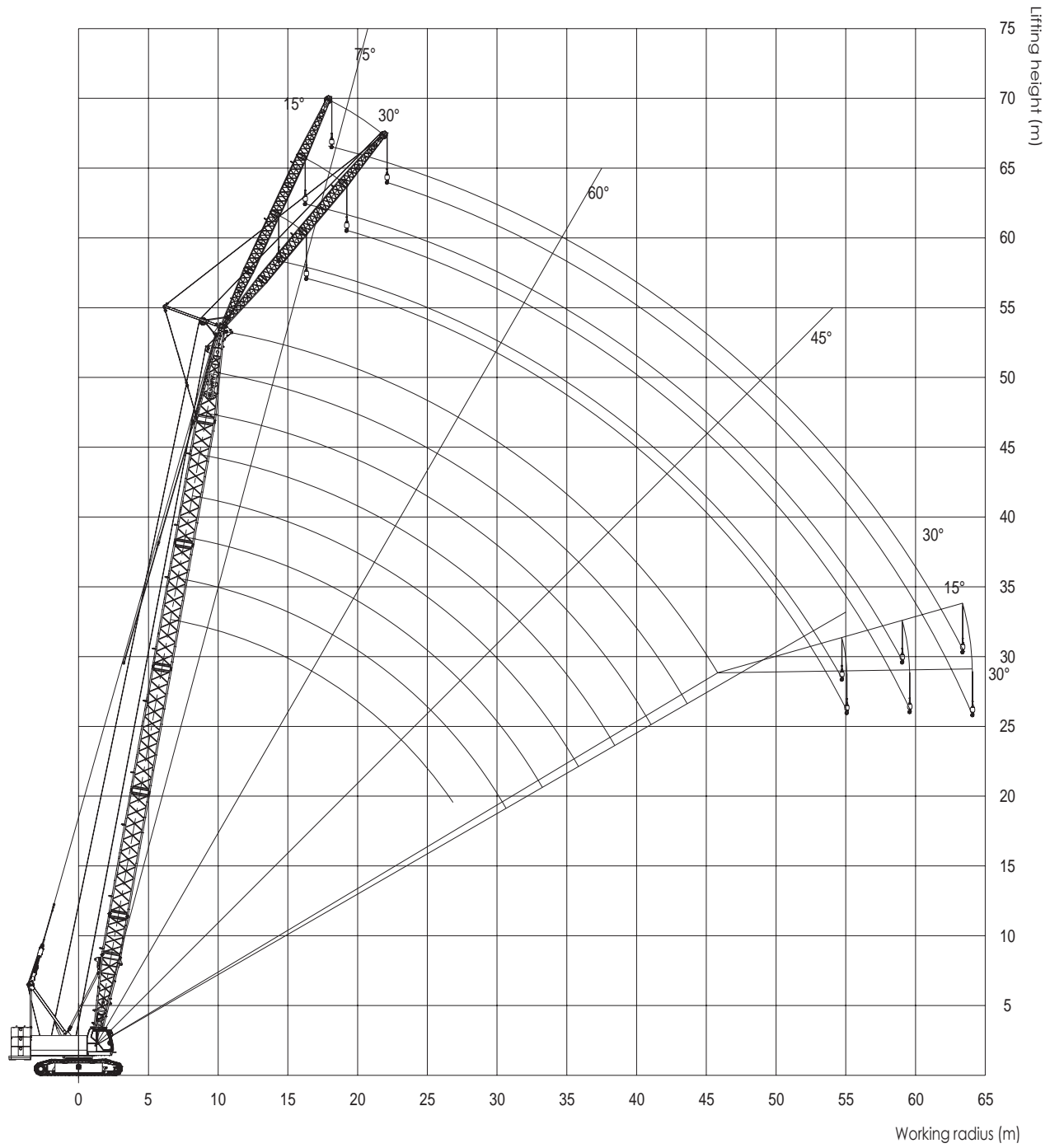

Lifting height working range curve



FJ OPERATING CONDITION LOAD CHART

SCC8100 FJ operating condition - 13.5m jib load chart BOOM No.1513A + JIB No.0807A 27.4t+10.0t 360°

Unit: (t)

Radius (m)	31	34	37	40	43	46	49	52	Radius (m)
12	7.0	-	-	-	-	-	-	-	12
14	7.0	7.0	7.0	7.0	7.0	7.0	-	-	14
16	7.0	7.0	7.0	7.0	7.0	7.0	7.0	7.0	16
18	7.0	7.0	7.0	7.0	7.0	7.0	7.0	7.0	18
20	7.0	7.0	7.0	7.0	7.0	7.0	7.0	7.0	20
22	7.0	7.0	7.0	7.0	7.0	7.0	7.0	7.0	22
24	7.0	7.0	7.0	7.0	7.0	7.0	7.0	7.0	24
26	7.0	7.0	7.0	7.0	7.0	7.0	7.0	7.0	26
28	7.0	7.0	7.0	7.0	7.0	6.8	6.7	6.6	28
30	6.8	6.7	6.5	6.4	6.2	6.1	6.0	5.8	30
32	6.2	6.1	5.9	5.8	5.6	5.5	5.4	5.2	32
34	5.7	5.5	5.4	5.2	5.1	4.9	4.8	4.6	34
36	5.2	5.0	4.9	4.7	4.6	4.4	4.3	4.2	36
38	4.7	4.6	4.4	4.3	4.1	4.0	3.9	3.7	38
40	4.3	4.2	4.0	3.9	3.7	3.6	3.5	3.3	40
42	-	3.8	3.7	3.6	3.4	3.3	3.1	3.0	42
44	-	-	3.4	3.2	3.1	2.9	2.8	2.6	44
46	-	-	3.1	2.9	2.8	2.6	2.5	2.4	46
48	-	-	-	2.7	2.5	2.4	2.2	2.1	48
50	-	-	-	-	2.3	2.1	2.0	1.8	50
52	-	-	-	-	-	1.9	1.8	1.6	52
54	-	-	-	-	-	1.7	1.6	1.4	54
56	-	-	-	-	-	-	1.4	1.2	56
58	-	-	-	-	-	-	-	1.0	58

- Notes: 1.The actual weight is a value that the rated weight in this table is subtracted by the weights of the hooks, hangers, and wire ropes winding on the hooks and on the boom head.
2.The rated load in table refers to a value under the condition that the heavy load is lifted slowly and smoothly from the level and hard soil ground.



Notes

Notes section containing horizontal dashed lines for text entry.

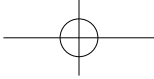

Notes

A large area of the page containing horizontal dashed lines for handwritten notes.

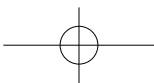
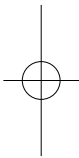
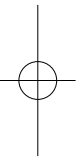



Quality Changes the World

SANY GROUP CO., LTD.

Address: SANY Industrial Park, Economic and Technological
Development Zone, Changsha, Hunan, China

Service Hotline: +0086-4006-098-318

E-mail: crd@sany.com.cn

For more information, please visit: www.sanygroup.com

B05S2ENAM1-SCC8100

