

Outline Dimensions

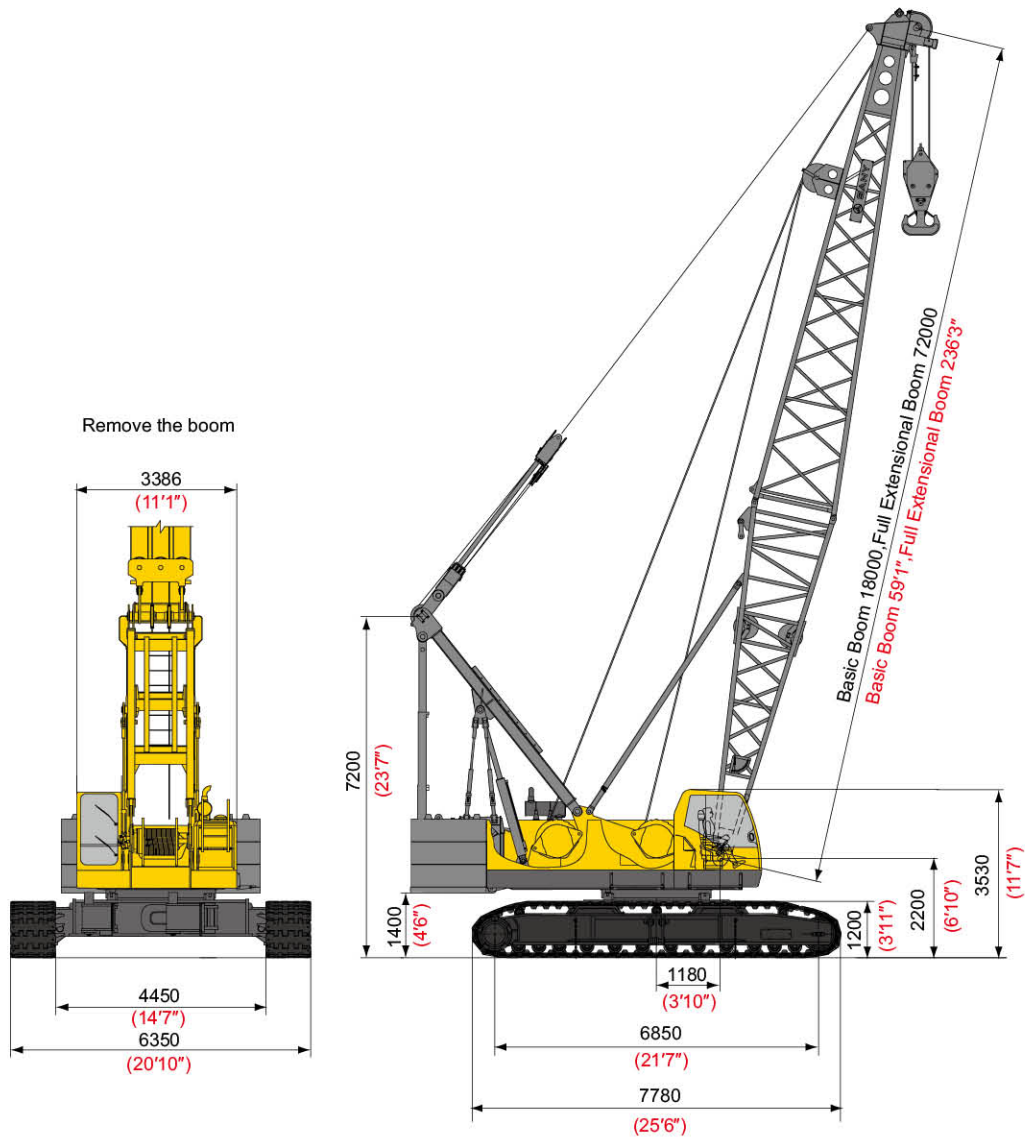

Outline Dimensions of SCC1000C Hydraulic Crawler Crane

Performance Data

(Main Performance Data of SCC1000C Hydraulic Crawler Crane)			
Performance Index		Unit	Data
H Operating Condition	Max. Rated Load	mt	105
	Boom Length	m	18~72
	Boom Luffing Angle		30 ° ~ 80°
FJ Operating Condition	Full Extensional Boom+ Full Extensional Jib	m	(60 + 25) / (63+19)
	Jib Offset Angle		15° , 30°
Working Speed	Wire Speed of Main and Aux. Hoisting Winch	m/min	0 ~ 110
	Wire Speed of Luffing Winch	m/min	0 ~ 73
	Slewing Speed	rpm	0~1.9 (no load)
	Traveling Speed	km/h	0~1.0/0~0.68 (two speeds)
	Gradeability		30%
Engine	Output Power/Rated Rotational Speed	kW/rpm	183 (Tier 3) 2000(Tier 3) 186 (Tier 2) 2200(Tier 2)
Transport Data	Max. Transport Weight of Single Part	kg	43500
	Transport Dimensions (length × width × height)	mm	9500 × 3400 × 3400
	Average Ground Pressure Bearing (with Basic Boom)	Mpa	0.085

Transport Dimensions

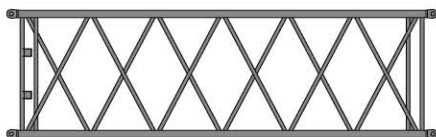
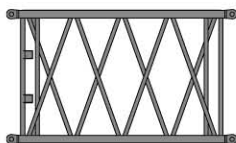
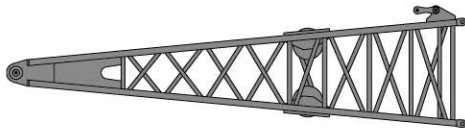
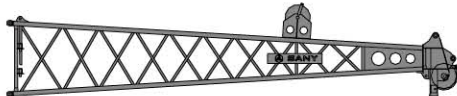
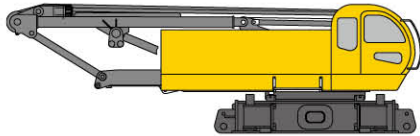
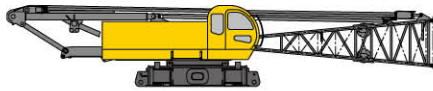

Basic machine		× 1
Length	16m	52' 6"
Width	3.4m	11' 2"
Height	3.4m	11' 2"
Weight	46000kg	101400lb

Basic machine		× 1
Length	9.5m	31' 2"
Width	3.40m	11' 2"
Height	3.05m	10' 0"
Weight	43500kg	95900lb

Crawler Assembly		× 2
Length	7.78m	25' 6"
Width	0.95m	3' 1"
Height	1.20m	3' 11"
Weight	16500kg	36376lb

Boom tip		× 1
Length	10.92m	35' 10"
Width	1.81m	5' 11"
Height	2.24m	7' 4"
Weight	2100kg	4630lb

Boom base		× 1
Length	7.73m	25' 4"
Width	1.81m	5' 11"
Height	2.03m	6' 8"
Weight	2500kg	5511lb

3m Boom insert (9' 10")		× 2
Length	3.14m	10' 4"
Width	1.81m	5' 11"
Height	1.83m	6' 0"
Weight	600kg	1323lb

6m Boom insert (19' 8")		× 2
Length	6.14m	20' 2"
Width	1.81m	5' 11"
Height	1.83m	6' 0"
Weight	950kg	2094lb

Transport Dimensions

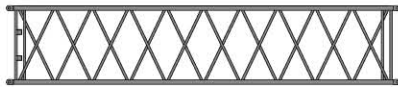

9m Boom insert A (29' 6")		× 3
Length	9.14m	29' 12"
Width	1.81m	5' 11"
Height	1.83m	6' 0"
Weight	1300kg	2866lb

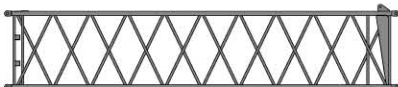

9m Boom insert B (29' 6")		× 1
Length	9.14m	29' 12"
Width	1.81m	5' 11"
Height	1.83m	6' 0"
Weight	1500kg	3307lb



Jib tip		× 1
Length	5.36m	17' 7"
Width	1.01m	3' 4"
Height	1.17m	3' 10"
Weight	300kg	661lb



Jib base		× 1
Length	5.11m	16' 9"
Width	1.03m	3' 5"
Height	0.83m	2' 9"
Weight	200kg	441lb

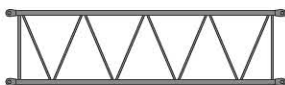

3m Jib insert (9' 10")		× 1
Length	3.08m	10' 1"
Width	1.01m	3' 4"
Height	0.83m	2' 9"
Weight	100kg	220lb

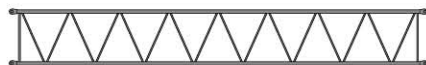

6m Jib insert (19' 8")		× 2
Length	6.08m	19' 11"
Width	1.01m	3' 4"
Height	0.83m	2' 9"
Weight	200kg	441lb

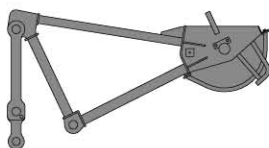

Boom extension		× 1
Length	2.12m	6' 11"
Width	1.04m	3' 5"
Height	1.12m	3' 8"
Weight	300kg	661lb

Transport Dimensions

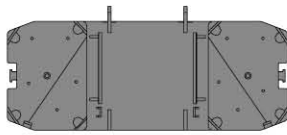

Counterweight tray		×1
Length	4.20m	13' 9"
Width	1.82m	5' 12"
Height	0.50m	1' 8"
Weight	6600kg	14550lb



Counterweight Block		×6
Length	1.60m	5' 3"
Width	1.19m	3' 11"
Height	0.55m	1' 10"
Weight	6000kg	13228lb



Additional Counterweight Block		×1
Length	0.93m	3' 1"
Width	0.66m	2' 2"
Height	1.00m	3' 3"
Weight	3000kg	6614lb

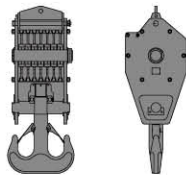

100t (110USst) hook block		×1
Length	2.17m	7' 1"
Width	0.81m	2' 8"
Height	0.89m	2' 11"
Weight	1600kg	3527lb

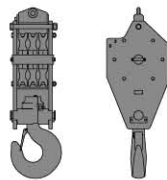

50t (55USst) hook block		×1
Length	1.97m	6' 6"
Width	0.43m	1' 5"
Height	0.89m	2' 11"
Weight	900kg	1984lb

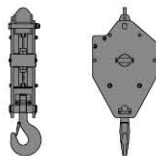

25t (27.6USst) Hook Block		×1
Length	1.60m	5' 3"
Width	0.42m	1' 5"
Height	0.80m	2' 7"
Weight	550kg	1213lb

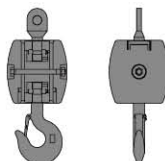

9t (9.9USst) hook block		×1
Length	0.95m	3' 1"
Width	0.36m	1' 2"
Height	0.36m	1' 2"
Weight	250kg	551lb

Notes:

1. The transport dimensions of main parts are not drawn to proportion. The dimensions in the sketches are design values excluding packages.

1. The weight is design value and there may be difference caused during manufacturing.

Assembly

This crane is equipped with functions including the self-assembly/disassembly of crawler tracks and self-assembly/disassembly of counterweight. In the process of assembly, the crawler traveling tracks shall be assembled first and then the counterweight. In the process of disassembly, the counterweight shall be disassembled first and then the crawler traveling tracks. See the figures for detailed operation procedures.

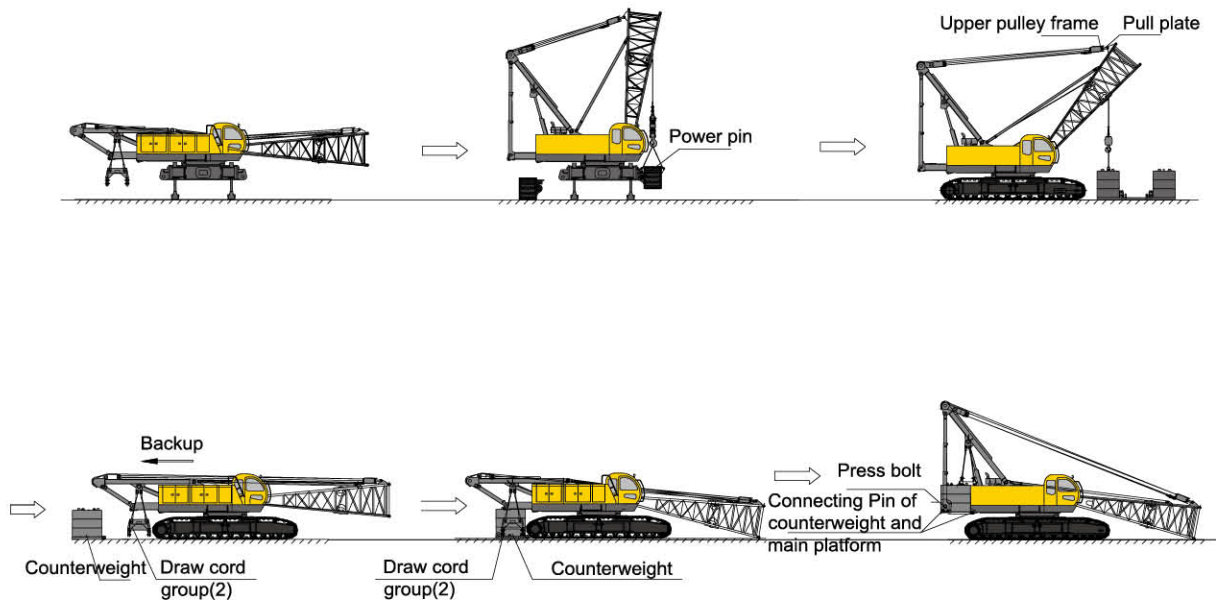

Schematic Diagram of Self-assembly of Crawler Frame and Counterweight
(perform disassembly in exactly reverse order)

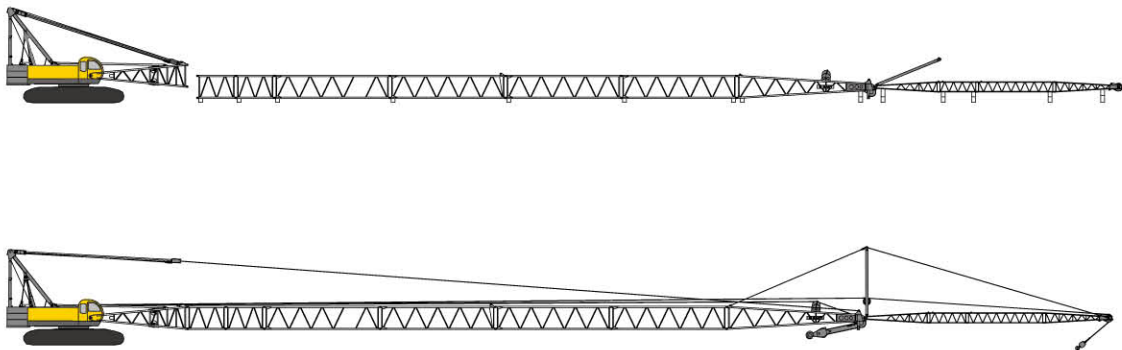

Schematic Diagram of Jib Assembly

Specifications



Upperworks



Engine

The imported Cummins Model QSC8.3 diesel (Tier 3), inline 6-cylinders, water-cooled, electronic-controlled, turbo-charging, rated at 183kW (246hp) at 2000rpm. The maximum torque output is 1268N•m (936 lb•ft), at 1400rpm.

Air Filtering: Two-stage air filtering system including an air pre-filter and an air filter.

Fuel tank capacity: 400L(106 gal).

Imported Cummins Model 6CTAA-250 diesel (Tier 2), rated at 186kW(250hp)/ 2200rpm, maximum torque output is 1219N•m (900 lb•ft), at 1300rpm.



Electrical Controlling System

Composed of central controlling unit, man-machine interfaces, sensors, actuators, and connecting wires.

Data transmission between the controller, display, engine, load moment limiter, and remote controlling termination is achieved by CAN bus technology, enabling high reliability for the system.

Information including working parameters (e.g. rotational speed of the engine, fuel volume, engine oil pressure, servo pressure, wind speed, engine working hours) and working state (e.g. main winch lockup, main luffing winch lockup, slewing lockup) is shown on the display.

Security: design of electrical system fully complying with CE standards, multi safety limit switches, full range of safety signals, main components complying with CE standards.

Reliability: products of internationally or industrially well-known brands are employed in main electrical components, which include the load moment limiter, controller, display, sensor, detecting switches, control switches, wires and cables.



Hydraulic System

The Hydraulic system configurations: Rexroth (R) or Kawasaki (K), both can achieve inching control.

Rexroth pump system: the main pump is controlled by LAO, which is summation power adjustment plus electronic power adjustment override control, enabling load-sensitive function.

Rexroth main valve: integral multi-port valve, which can achieve LUDV, i.e. Load Independent Flow Distribution. If

the flow in the system is inadequate, i.e. the pump unable to supply adequate flow for actuator components acting at required speed, each actuator component will reduce its speed in proportion.

Independent closed slewing system.

Kawasaki pump system: the main pump is controlled by positive flow plus summation power. The displacement of main pump is proportional to control signal. When the summation output pressure of dual pump reaches the pre-set value, the displacement changing mechanism begin to act synchronically and reduce the pump displacement, keeping the summation output power of the pump constant. In addition, when the slewing pump and the main pump working at the same time, the cross power control can be achieved, avoiding the engine from working overloaded.

Kawasaki main valve: open-centered control valve unloaded at neutral position, which is hydraulic pilot proportional controlled. Spool of each valve is connected in series, achieving compound actions at light load. It is optional to install pressure compensated valve at the upstream of each spool, which can reduce the variation in load flow characteristics caused by change of load, enabling good adaptability for the operator.

Independent open slewing system

Oil cooler: oil radiator directly driven by hydraulic motor.

Hydraulic oil tank capacity: 320L (84.5gal)



Main & Auxiliary Hoisting Mechanism

The main winch drum and the auxiliary winch drum are separately driven by winch motors through gearboxes. Operate the hoisting control levers to achieve rolling in two directions, i.e. hoisting and lowering the hook block.

Brake: normally closed, built-in, wet, blade-type, spring loaded; spring-applied and hydraulically-released.

Main & Aux. Hoisting Winch	Outermost Speed of Wire Rope	0 ~ 110m/min (0 ~ 361fpm)
	Wire Rope Diameter	Φ24mm (15/16")
	Wire Rope Length of Main/Aux. Winch	290m/210m (951' 5"/688' 12")
	Rated Single-line Pull	9,200kg (20,300lb)

Specifications

Winch drum: using fold line groove winch drum to avoid entangling during winding the ropes into multi layers.



Luffing Mechanism

The luffing winch drum is directly driven by luffing motors through gearbox. Operate the luffing control lever to achieve rolling in two directions, i.e. raising and lowering the boom/jib.

Brake: normally closed, built-in, wet, blade-type, spring loaded; spring-applied and hydraulically-released.

Winch drum: using fold line groove winch drum to avoid entangling during winding the ropes into multi layers.

Luffing Winch	Outermost Speed of Wire Rope	0 ~ 73m/min (0 ~ 239fpm)
	Wire Rope Diameter	Φ20mm (13/16")
	Wire Rope Length of luffing Winch	240m (787' 5")
	Rated Single-line Pull	6,900kg (15,300lb)



Slewing Mechanism

Internal gearing slewing driving system, allowing 360°rotation.

Brake: normally closed, built-in, wet, blade-type, spring loaded; spring-applied and hydraulically-released.

Slewing lock: hydraulically-controlled locking pin is provided to ensure the upperworks are securely locked after work completion or during transportation.

Free slipping: during hoisting load, the center of gravity of the load and that of the boom might not be in the same plane due to mis-judging, when, the function of free slipping will rectify the upperworks to prevent the suspended load from wiggling.

Slewing ring: Triple-row roller slewing ring

Slewing Speed: 0~1.9rpm(no load)



Driver's Cab

The sliding door of cab allows easy and safe opening and closing. The large window, together with lower beam and upper beam head lights and rearview mirror permits broad viewing area; location of air conditioner,

MP3 player, seat, control levers, control buttons are all arranged ergonomically, making the operation more comfortable.

Armrest box: the left and right armrest boxes are installed with control levers, electric switches, and ignition lock. The armrest boxes can also adjust with the seat.

Seat: suspension, multi-direction, multi-position, installed with function locking device.

Air conditioner: cool and warm wind, optimal wind tunnel and wind port.



Counterweight

The casting counterweight blocks are installed by piling one by one on counterweight tray, making easy assembly, disassembly and transportation.

Standard counterweight weight is 42,000kg (92,600lb) in total, containing one 6,000kg(13,230lb) counterweight tray, six 6,000kg (13,230lb) counterweight blocks.

One additional counterweight block of 3,000kg(6,620lb)

Using the additional counterweight block in certain conditions with medium or long booms can improve the hoisting capability of the crane.



Lowerworks

Independent traveling drive is provided in each crawler frame. The hydraulic traveling motor drives gear reducer to achieve straight-line traveling and steering.

Brake: normally closed, built-in, wet, blade-type, spring loaded; spring-applied and hydraulically-released.

Crawler tensioning is achieved by adjusting the shim plates with the guide rollers supported by hydraulic jacks. Crawler pads are made of high-strength alloy steel casting.

Traveling speed (low): 0~0.68 km/h(0~0.42mph)

Traveling speed (high): 0~1.0 km/h (0~0.62mph)



Operation Device



Boom

Lattice structure, main chords use high-strength alloy steel pipe. Boom sections are connected by pin shafts.

Basic boom is composed of one 10.5m(34'5") boom tip and one 7.5m(24'7") boom base.

Specifications

Boom inserts: 3m×2(9'10"×2), 6m×2(19'8"×2),
9mA×3(29'6"A×3), 9mB×1(29'6"B×1)
Boom length: 18m~72m (59'1"~236'3").

Jib

Lattice structure. Main chords use high-strength alloy steel pipe. Jib sections are connected by pin shafts.

Basic jib is composed of one 5m(16'5") jib base, one 5m(16'5") jib tip, and one 3m(9'10") jib insert.

Jib inserts: 6m×2 (19'8"×2);

Jib length: 13m~25m (42'8"~82')

Full Extensional Boom + Full Extensional Jib: 49m(160'9") boom + 25m (82') jib or 63m (206'8") boom + 19m (62'4") jib.

Hook Blocks

100t (110USt) hook block

50t (55USt) hook block

25t (27.6USt) hook block

9t (9.9USt) ball hook

Note: the above-mentioned devices are the complete configurations. Actual configuration see the purchase contract.



Safety Devices

Switch for Assembling Mode / Operating Mode

The over-hoist limit device, over roll-out limits switch, A-frame alarming device and load moment limiter can be overridden in the assembling mode.

While under normal operating mode, all these safety devices are functioning.

Emergency Stop

When emergency occurs, press this button to cut off the electricity and stop all the operations.

Emergency Operating

If an operating system failure occurs, the emergency electric plugs can be connected to the standby power. Then the crane can be operated to safe state. During emergency operation, all safety devices stop functioning.

Load Moment Limiter

The load moment limiter is independently controlled by

computer and displays the actual load on the boom. It automatically detects the weight hoisted by the crane and the angle of boom, as well as displays the rated load, actual load, operating radius and angle of boom.

Components: host machine, monitor, angle sensor and force sensor etc.

Function: instantaneously display the rated load, actual load, operating radius, angle and height of the boom under the current situation of the crane. Automatically detect the dynamic data of an overload and sounds an alarm immediately and stop the operation.

Over-hoist Limit Device for Main and Auxiliary Hooks

The limit switch and anti-two block on the upper boom are used to prevent the hook from being lifted too high. When the hook is lifted to a certain height, the limit switch is activated with a buzzer on the control board sending an alarm to both electronic and hydraulic controls, and the hook lifting operation stops automatically.

Over Roll-out Limit Device for Main and Auxiliary Hooks

It is composed of the motion trigger device fixed inside of the drum and a proximity switch. It can send a signal when the wire rope is rolled out with only three wraps left on the drum. The electronic controlling system can automatically stop the hooks and send alarm through the buzzer and monitor.

Function Locking

If the function locking joystick is not in position or the operator is not at seat, all the other control levers are out of commission so as to prevent mis-operation.

Winch Lock Device

Electronic controlled locking device is set in all the winch drums, which means it is essential to release the ratchet before the winding operation so as to prevent the mis-operation caused by lever and to guarantee the safety when the winding is under non-operating mode.

Slewing Lock Device

It uses hydraulic power pin to lock the upperworks at front or back. The slewing pin is electrically controlled, which can coordinate the slewing operation and prevent mis-operation.

Specifications

➤ A-frame Alarming Device

Under normal operating mode, the A-frame alarm system is activated. The system sends an alarm through the buzzer and display, and all the operations stops at the same time.

➤ Boom Limit Device

When the boom angle is over 78°, the alarm buzzer sounds, and the luffing winch is stopped. The lowering operation is allowed. This protection function is the small for the load moment limiter and anti-two block switch.

When the angle of the boom is lower than 30°, the system sends an alarm through the buzzer and display of combined instruments. At the same time, the boom stops. The raising operation is allowed. This safeguard function is automatically controlled by load moment limiter.

➤ Boom Back-stop Device

The back-stop rod is made of nested steel pipe and spring structure fixed on the top of the lower boom, which is equipped with the function of support through the spring pressure so as to prevent the main boom retroversion.

➤ Boom Angle Indicator

Pendulum-type angle indicator mounted at the side close to the driver's cab of the boom base.

➤ Hook Clamp

Each kind of lifting hook is equipped with a clamp plate to prevent the hoisting wire rope from falling off.

➤ Monitoring System

Camera: 2 cameras, respectively for monitoring the auxiliary winch, luffing winch and the situation of the rear of the crane for the complete appliance.

Optional: zoom camera, monitoring the working state of the hooks.

Optional: remote monitoring system, which is equipped with GPS and GPRS for data transmission, device status inquiry and data statistical analysis, running data supervision and analysis, and fault remote diagnosis.

➤ Lightning Protection Device

It includes grounding devices and surge-protect device, which can prevent the damage to the electronic components and the hurt to the staff from lightning.

➤ Gradienter

Electronic gradienter can indicate the inclining angle of the upperworks on the monitor of the control system.

➤ Tri-color Load Alarming Light

The load alarming light includes 3 colors, which can display the instantaneous load synchronously. Namely, the green color means the load rate is less than 92%, the yellow color means the load rate is between 92% to 100% and the red color means the load rate is over 100%, which is in overload situation. When the yellow light is on, the pre-alarm light begins to flicker and sound a discontinuous alarm; when the red light is on, the pre-alarm begins to flicker and sound a continuous alarm; when the actual load reaches 102% of rated load, the system will cut off those operations prone to danger.

➤ Audio-visual Alarm

When the engine is working, the alarm light is flickering; when the crane is traveling or slewing, it sounds an alarm.

➤ Slewing Indicator

When the crane is traveling or slewing, the slewing indicator is flickering all the time.

➤ Illumination

Night illuminating devices such as winch illuminator, dipped light in front of the driver's cab, angle adjustable high beam and head lamp in driver's cab are installed so as to improve safety for construction during night.

➤ Rearview Mirror

The mirrors shall be respectively set at the right side of the driver's cab and the front handrail of the left cover.

➤ Pharos

It is installed at the top of the boom system to send signal of height and hence allows the boom system to keep erecting at night.

➤ Anemometer

It is installed at the top of the boom system to detect real-time wind speed and can transmit the data to the driver's cab for display on the monitor.

Key Words



Operating radius
Radius (R)



Main boom (H)
Boom angle
Mixed main boom (HJ)
Light main boom (H_L)

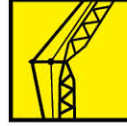

Fixed jib (FJ)
Fixed short jib (SF)
Light fixed short jib (SF_L)
Heavy fixed short jib (SF_H)



Luffing jib (LJ)



Superlift counterweight (B)
Superlift mast (D)



Superlift radius



Counterweight

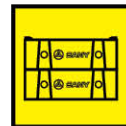

Central ballast

Operating Condition Code:

H: Heavy main boom

H_L: Light main boom

HD (HDB): Heavy main boom + superlift mast (+ superlift counterweight)

HJ: Mixed main boom

HJD (HJDB): Mixed main boom + superlift mast (+ superlift counterweight)

FJ: Fixed jib

LJ: Luffing jib

LJD (LJDB): Luffing jib + superlift mast (+ superlift counterweight)

SF: Fixed short jib

SF_L: Light fixed short jib

SF_LD SF_LDB): Light fixed short jib + superlift mast (+ superlift counterweight)

SF_H: Heavy fixed short jib

SF_HD (SF_HDB): Heavy fixed short jib + superlift mast (+ superlift counterweight)

Note: These keywords are general terms. A specific product may not use all of them.

Operating Conditions

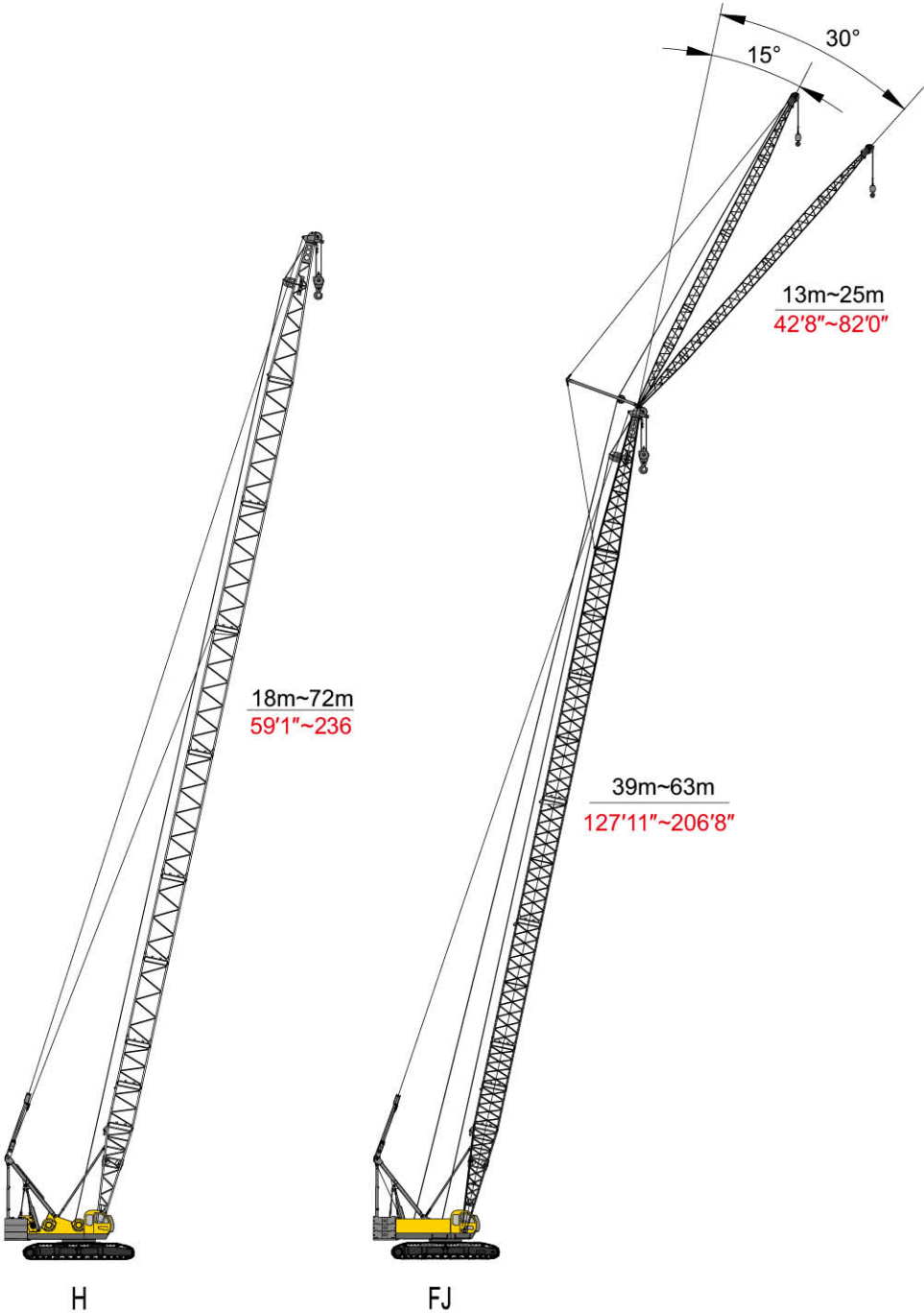

H Operating Condition/ Combination of Boom

Boom Length (m) (ft)	Boom Insert			
	3m (9' 10")	6m (19'8")	9mA (29'6")	9mB (29'6")
18 (59'1")	-	-	-	-
21 (68'11")	1	-	-	-
24 (78'9")	-	1	-	-
	2	-	-	-
27 (88'7")	1	1	-	-
	-	-	1	-
30 (98'5")	1	-	1	-
	-	2	-	-
33 (108'3")	1	2	-	-
	-	1	1	-
36 (118'1")	1	1	1	-
	-	-	2	-
	2	2	-	-
39 (127'11")	2	1	1-	-
	1	-	2	-
	-	2	1	-
42 (137'10")	2	-	2	-
	-	1	2	-
45 (147'8")	1	1	2	-
	-	-	3	-
	2	2	1	-
48 (157'6")	1	-	3	-
	2	1	2	-
	-	2	2	-
51 (167'4")	-	1	3	-
	2	-	3	-
54 (177'2")	2	2	2	-
	1	1	3	-
57 (187')	2	1	3	-
	-	2	3	-
60 (196'10")	1	2	2	1
	2	-	3	1
63 (206'8")	2	2	2	1
66 (216'6")	2	1	3	1
69 (226'5")	1	2	3	1
72 (236'3")	2	2	3	1

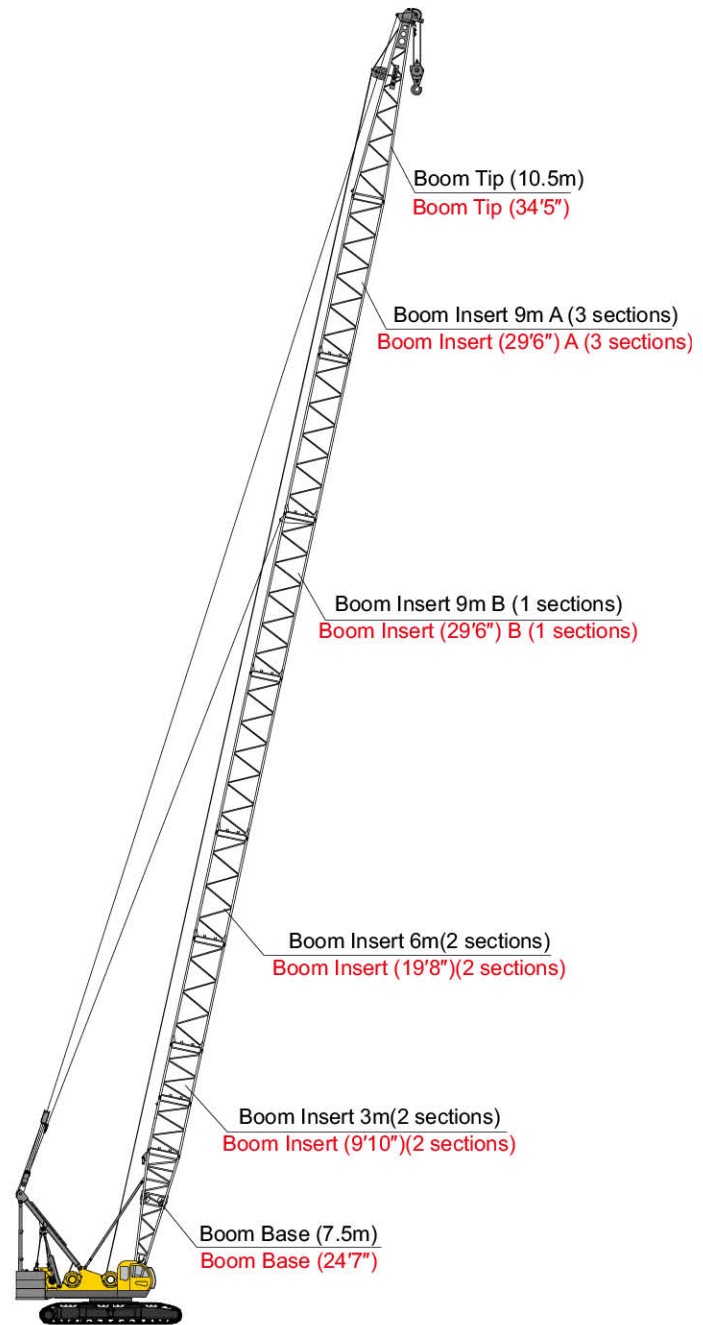

Combination of Boom (18m ~ 72m) (59' 1" ~ 236' 3")

Operating Range Diagram

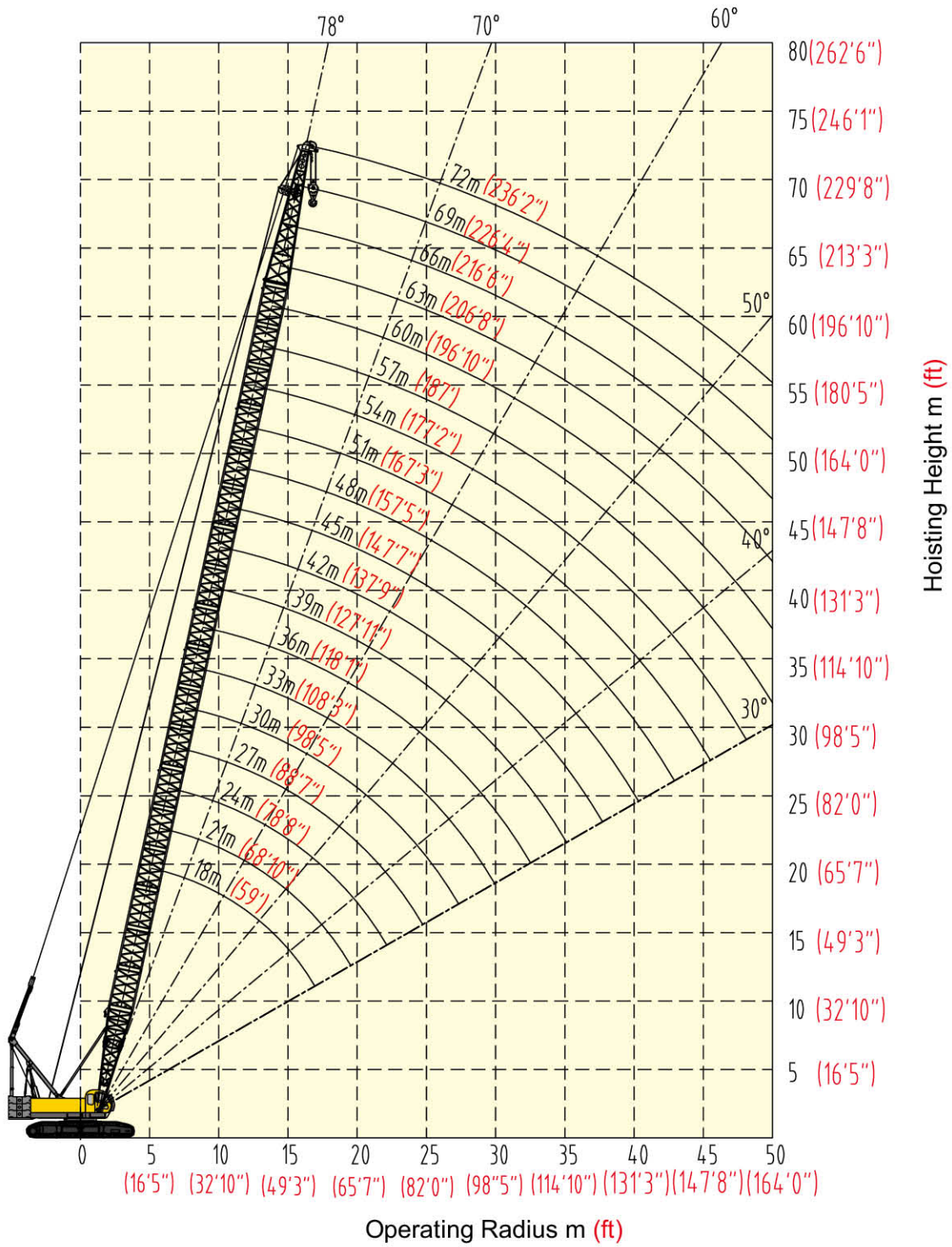

Load Charts of H Operating Condition

Main Boom Load Charts 1/4								kg(lb)×1000
Radius m (ft)	Boom m (ft)	18m	21m	24m	27m	30m	33m	36m
		(59'1")	(68'11")	(78'9")	(88'7")	(98'5")	(108'3")	(118'1")
5.1 (16'9")		105.0 (231.5)						
5.5 (18'1")		100.0 (220.5)	5.6/90.9 (18'4"/200.4)					
6.0 (19'8")		92.5 (203.9)	90.0 (198.4)	6.1/80.8 (20'0"/178.1)	6.6/70.8 (21'8"/156.1)			
7 (22'12")		79.5 (175.3)	78.7 (173.5)	77.5 (170.9)	70.0 (154.3)	7.2/60.5 (23'7"/133.4)	7.7/57.3 (25'3"/126.3)	
8 (26'3")		66.0 (145.5)	65.7 (144.8)	65.5 (144.4)	64.6 (142.4)	60.0 (132.3)	56.6 (124.8)	8.2/50.5 (26'11"/111.3)
9 (29'6")		55.2 (121.7)	55.1 (121.5)	54.9 (121)	54.8 (120.8)	54.7 (120.6)	54.2 (119.5)	50.0 (110.2)
10 (32'10")		47.5 (104.7)	47.3 (104.3)	47.2 (104.1)	47.1 (103.8)	46.9 (103.4)	46.8 (103.2)	46.6 (102.7)
12 (39'4")		36.9 (81.3)	36.7 (80.9)	36.5 (80.5)	36.4 (80.2)	36.3 (80)	36.1 (79.6)	36.0 (79.4)
14 (45'11")		30.1 (66.4)	29.8 (65.7)	29.6 (65.3)	29.5 (65)	29.3 (64.6)	30.2 (66.6)	29.1 (64.2)
16 (52'6")		25.2 (55.6)	25.0 (55.1)	24.8 (54.7)	24.7 (54.5)	24.5 (54)	24.3 (53.6)	24.2 (53.4)
18 (59'1")		17.5/21.7 (57'5"/47.8)	21.5 (47.4)	21.2 (46.7)	21.1 (46.5)	20.9 (46.1)	20.8 (45.9)	20.7 (45.6)
20 (65'7")			19.4 (42.8)	18.6 (41)	18.4 (40.6)	18.2 (40.1)	18.0 (39.7)	17.9 (39.5)
22 (72'2")			21.1/17.1 (69'3"/37.7)	17.0 (37.5)	16.3 (35.9)	16.1 (35.5)	15.9 (35.1)	15.8 (34.8)
24 (78'9")				22.7/14.7 (74'6"/32.4)	14.5 (32)	14.2 (31.3)	14.1 (31.1)	14.0 (30.9)
26 (85'4")					25.4/12.8 (83'4"/28.2)	12.7 (28)	12.6 (27.8)	12.5 (27.6)
28 (91'10")						11.1 (24.5)	11.4 (25.1)	11.3 (24.9)
30 (98'5")							10.5 (23.1)	10.3 (22.7)
32 (104'12")							30.7/9.7 (100'9"/21.4)	9.4 (20.7)
34 (111'7")								33.3/8.6 (109'3"/19)
Counterweight kg(lb)×1000		42 (92.6)	42 (92.6)	42 (92.6)	42 (92.6)	42 (92.6)	42 (92.6)	42 (92.6)
Multiplying factor		14	12	10	8	7	7	7

- Notes: 1. Actual hoisting capacity is rated multiplying factor in the table minus weight of hoisting hook and all hoisting tools.
 2. Rated load indicated in the table is weight hoisted by the crane on horizontal and hard ground surface.
 3. Cells 40% grayed and italicized indicate that the operating condition is with both the standard counterweight and additional counterweight; and cells framed and grayed indicate that the lifting capacity depends on strength of boom system.
 4. To prevent retroversion, a boom frame longer than 39m (127'11") should be connected before placing additional counterweight. Additional counterweight is strictly forbidden with boom frame shorter than 39m(127'11").

Load Charts of H Operating Condition

Main Boom Load Charts 2/4									kg(lb)×1000
Boom m(ft)	39m (127'11")		42m (137'10")		45m (147'8")		48m (157'6")		
Radius m(ft)									
8 (26'3")	8.7/46.6 (28'7"/102.7)	8.7/49.4 (28'7"/108.9)							
9 (29'6")	46.2 (101.9)	49.0 (108)	9.3/44.2 (30'6"/97.4)	9.3/46.9 (30'6"/103.4)	9.8/41.2 (32'2"/90.8)	9.8/43.7 (32'2"/96.3)			
10 (32'10")	44.7 (98.5)	47.4 (104.5)	42.4 (93.5)	44.9 (99)	40.4 (89.1)	42.8 (94.4)	10.3/35.6 (33'10"/178.5)	10.3/37.7 (33'10"/83.1)	
12 (39'4")	35.9 (79.1)	38.1 (84)	35.8 (78.9)	37.9 (83.6)	35.7 (78.7)	37.8 (83.3)	33.7 (74.3)	35.7 (78.7)	
14 (45'11")	28.9 (63.7)	30.6 (67.5)	28.8 (63.5)	30.5 (67.2)	28.7 (63.3)	30.4 (67)	28.6 (63.1)	30.3 (66.8)	
16 (52'6")	24.0 (52.9)	25.4 (56)	23.9 (52.7)	25.3 (55.8)	23.8 (52.5)	25.2 (55.6)	23.7 (52.2)	25.1 (55.3)	
18 (59'1")	20.5 (45.2)	21.7 (47.8)	20.4 (45)	21.6 (47.6)	20.2 (44.5)	21.4 (47.2)	20.1 (44.3)	21.3 (47)	
20 (65'7")	17.7 (39)	18.8 (41.4)	17.6 (38.8)	18.7 (41.2)	17.5 (38.6)	18.6 (41)	17.4 (38.4)	18.4 (40.6)	
22 (72'2")	15.6 (34.4)	16.5 (36.4)	15.5 (34.2)	16.4 (36.2)	15.3 (33.7)	16.2 (35.7)	15.2 (33.5)	16.1 (35.5)	
24 (78'9")	13.7 (30.2)	14.5 (32)	13.6 (30)	14.4 (31.7)	13.5 (29.8)	14.3 (31.5)	13.3 (29.3)	14.1 (31.1)	
26 (85'4")	12.3 (27.1)	13.0 (28.7)	12.2 (26.9)	12.9 (28.4)	12.0 (26.5)	12.7 (28)	11.9 (26.2)	12.6 (27.8)	
28 (91'10")	11.0 (24.3)	11.7 (25.8)	10.9 (24)	11.6 (25.6)	10.8 (23.8)	11.4 (25.1)	10.6 (23.4)	11.2 (24.7)	
30 (98'5")	10.0 (22)	10.6 (23.4)	9.9 (21.8)	10.5 (23.1)	9.7 (21.4)	10.3 (22.7)	9.6 (21.2)	10.2 (22.5)	
32 (104'12")	9.1 (20.1)	9.6 (21.2)	9.0 (19.8)	9.5 (20.9)	8.8 (19.4)	9.3 (20.5)	8.7 (19.2)	9.2 (20.3)	
34 (111'7")	8.4 (18.5)	8.9 (19.6)	8.2 (18.1)	8.7 (19.2)	8.1 (17.9)	8.6 (19)	7.9 (17.4)	8.4 (18.5)	
36 (118'1")	35.9/7.4 (117'9"/16.3)	35.9/7.8 (117'9"/17.2)	7.3 (16.1)	7.7 (17)	7.2 (15.9)	7.6 (16.8)	7.1 (15.7)	7.5 (16.5)	
38 (124'8")			6.8 (15)	7.2 (15.9)	6.7 (14.8)	7.1 (15.7)	6.5 (14.3)	6.9 (15.2)	
40 (131'3")			38.6/6.5 (126'8"/14.3)	38.6/6.9 (126'8"/15.2)	6.2 (13.7)	6.6 (14.6)	6.1 (13.4)	6.5 (14.3)	
42 (137'10")					41.2/5.6 (135'2"/12.3)	41.2/5.9 (135'2"/13)	5.5 (12.1)	5.8 (12.8)	
44 (144'4")							43.9/4.7 (144'0"/10.4)	43.9/5 (144'0"/11)	
Counterweight	42	42+3	42	42+3	42	42+3	42	42+3	
kg(lb)×1000	(92.6)	(92.6+6.6)	(92.6)	(92.6+6.6)	(92.6)	(92.6+6.6)	(92.6)	(92.6+6.6)	
Multiplying factor	6		5		5		5		

- Notes: 1. Actual hoisting capacity is rated multiplying factor in the table minus weight of hoisting hook and all hoisting tools.
 2. Rated load indicated in the table is weight hoisted by the crane on horizontal and hard ground surface.
 3. Cells 40% grayed and italicized indicate that the operating condition is with both the standard counterweight and additional counterweight; and cells framed and grayed indicate that the lifting capacity depends on strength of boom system.
 4. To prevent retroversion, a boom frame longer than 39m (127'11") should be connected before placing additional counterweight. Additional counterweight is strictly forbidden with boom frame shorter than 39m(127'11").

Load Charts of H Operating Condition

Main Boom Load Charts 3/4									kg(lb)×1000
Boom m (ft) Radius m (ft)	51m (167'4")		54m (177'2")		57m (187'0")		60m (196'10")		
	10 (32'10")	10.9/32.8 (35'9"/72.3)	10.9/34.8 (35'9"/76.7)	11.4/28.7 (37'5"/63.3)	11.4/30.4 (37'5"/67)	11.9/26.3 (39'0"/58)	11.9/27.9 (39'0"/61.5)		
12 (39'4")	30.3 (66.8)	32.1 (70.8)	28.2 (62.2)	29.9 (65.9)	26.2 (57.8)	27.8 (61.3)	12.4/24.5 (40'8"/54)	12.4/26 (40'8"/57.3)	
14 (45'11")	28.5 (62.8)	30.2 (66.6)	26.9 (59.3)	28.5 (62.8)	25.3 (55.8)	26.8 (59.1)	23.7 (52.2)	25.1 (55.3)	
16 (52'6")	23.5 (51.8)	24.9 (54.9)	23.4 (51.6)	24.8 (54.7)	23.2 (51.1)	24.6 (54.2)	22.1 (48.7)	23.4 (51.6)	
18 (59'1")	20.0 (44.1)	21.2 (46.7)	19.8 (43.7)	21.0 (46.3)	19.6 (43.2)	20.8 (45.9)	19.5 (43)	20.7 (45.6)	
20 (65'7")	17.2 (37.9)	18.2 (40.1)	17.1 (37.7)	18.1 (39.9)	16.9 (37.3)	17.9 (39.5)	16.8 (37)	17.8 (39.2)	
22 (72'2")	14.9 (32.8)	15.8 (34.8)	14.8 (32.6)	15.7 (34.6)	14.6 (32.2)	15.5 (34.2)	14.5 (32)	15.4 (34)	
24 (78'9")	13.2 (29.1)	14.0 (30.9)	13.0 (28.7)	13.8 (30.4)	12.8 (28.2)	13.6 (30)	12.7 (28)	13.5 (29.8)	
26 (85'4")	11.7 (25.8)	12.4 (27.3)	11.5 (25.4)	12.2 (26.9)	11.3 (24.9)	12.0 (26.5)	11.2 (24.7)	11.9 (26.2)	
28 (91'10")	10.5 (23.1)	11.1 (24.5)	10.3 (22.7)	10.9 (24)	10.1 (22.3)	10.7 (23.6)	10.0 (22)	10.6 (23.4)	
30 (98'5")	9.4 (20.7)	10.0 (22)	9.3 (20.5)	9.9 (21.8)	9.0 (19.8)	9.5 (20.9)	8.9 (19.6)	9.4 (20.7)	
32 (104'12")	8.5 (18.7)	9.0 (19.8)	8.4 (18.5)	8.9 (19.6)	8.1 (17.9)	8.6 (19)	8.0 (17.6)	8.5 (18.7)	
34 (111'7")	7.7 (17)	8.2 (18.1)	7.6 (16.8)	8.1 (17.9)	7.3 (16.1)	7.7 (17)	7.2 (15.9)	7.6 (16.8)	
36 (118'1")	7.0 (15.4)	7.4 (16.3)	6.9 (15.2)	7.3 (16.1)	6.6 (14.6)	7.0 (15.4)	6.5 (14.3)	6.9 (15.2)	
38 (124'8")	6.4 (14.1)	6.8 (15)	6.3 (13.9)	6.7 (14.8)	6.0 (13.2)	6.4 (14.1)	6.0 (13.2)	6.4 (14.1)	
40 (131'3")	5.9 (13)	6.3 (13.9)	5.7 (12.6)	6.0 (13.2)	5.5 (12.1)	5.8 (12.8)	5.4 (11.9)	5.7 (12.6)	
42 (137'10")	5.4 (11.9)	5.7 (12.6)	5.2 (11.5)	5.5 (12.1)	4.9 (10.8)	5.2 (11.5)	4.8 (10.6)	5.1 (11.2)	
44 (144'4")	4.6 (10.1)	4.9 (10.8)	4.5 (9.9)	4.8 (10.6)	4.4 (9.7)	4.7 (10.4)	4.3 (9.5)	4.6 (10.1)	
46 (150'11")	4.4 (9.7)	4.7 (10.4)	4.3 (9.5)	4.6 (10.1)	4.0 (8.8)	4.2 (9.3)	3.8 (8.4)	4.0 (8.8)	
48 (157'6")	46.5/3.9 (152'7"/8.6)	46.5/4.1 (152'7"/9)	3.6 (7.9)	3.8 (8.4)	3.5 (7.7)	3.7 (8.2)	3.4 (7.5)	3.6 (7.9)	
50 (164'0")			49.1/3.3 (161'1"/7.3)	49.1/3.5 (161'1"/7.7)	3.1 (6.8)	3.3 (7.3)	3.0 (6.6)	3.2 (7.1)	
52 (170'7")					51.8/2.7 (169'11"/6)	51.8/2.9 (169'11"/6.4)	2.6 (5.7)	2.8 (6.2)	
Counterweight kg(lb)×1000	42 (92.6)	42+3 (92.6+6.6)	42 (92.6)	42+3 (92.6+6.6)	42 (92.6)	42+3 (92.6+6.6)	42 (92.6)	42+3 (92.6+6.6)	
Multiplying factor	4		4		4		3		

- Notes: 1. Actual hoisting capacity is rated multiplying factor in the table minus weight of hoisting hook and all hoisting tools.
 2. Rated load indicated in the table is weight hoisted by the crane on horizontal and hard ground surface.
 3. Cells 40% grayed and italicized indicate that the operating condition is with both the standard counterweight and additional counterweight; and cells framed and grayed indicate that the lifting capacity depends on strength of boom system.
 4. To prevent retroversion, a boom frame longer than 39m (127'11") should be connected before placing additional counterweight. Additional counterweight is strictly forbidden with boom frame shorter than 39m (127'11").

Load Charts of H Operating Condition

Main Boom Load Charts 4/4									kg(lb)×1000
Radius m (ft)	63m		66m		69m		72m		
	(206'8")		(216'6")		(226'5")		(236'3")		
12 (39'4")	13.0/22.9 (42'8"/50.5)	13.0/24.3 (42'8"/53.6)	13.5/19.4 (44'3"/42.8)	13.5/20.6 (44'3"/45.4)					
14 (45'11")	21.8 (48.1)	23.1 (50.9)	19.2 (42.3)	20.4 (45)	14.1/17.8 (46'3"/39.2)	14.1/18.9 (46'3"/41.7)	14.6/16 (47'11"/35.3)	14.6/17 (47'11"/37.5)	
16 (52'6")	20.2 (44.5)	21.4 (47.2)	18.3 (40.3)	19.4 (42.8)	17.0 (37.5)	18.0 (39.7)	15.4 (34)	16.3 (35.9)	
18 (59'1")	19.4 (42.8)	20.6 (45.4)	17.5 (38.6)	18.6 (41)	16.2 (35.7)	17.2 (37.9)	14.6 (32.2)	15.5 (34.2)	
20 (65'7")	16.7 (36.8)	17.7 (39)	16.5 (36.4)	17.5 (38.6)	15.5 (34.2)	16.4 (36.2)	13.9 (30.6)	14.7 (32.4)	
22 (72'2")	14.4 (31.7)	15.3 (33.7)	14.2 (31.3)	15.1 (33.3)	14.0 (30.9)	14.8 (32.6)	13.0 (28.7)	13.8 (30.4)	
24 (78'9")	12.6 (27.8)	13.4 (29.5)	12.4 (27.3)	13.1 (28.9)	12.2 (26.9)	12.9 (28.4)	12.0 (26.5)	12.7 (28)	
26 (85'4")	11.1 (24.5)	11.8 (26)	10.9 (24)	11.6 (25.6)	10.7 (23.6)	11.3 (24.9)	10.5 (23.1)	11.1 (24.5)	
28 (91'10")	9.9 (21.8)	10.5 (23.1)	9.7 (21.4)	10.3 (22.7)	9.5 (20.9)	10.1 (22.3)	9.3 (20.5)	9.9 (21.8)	
30 (98'5")	8.8 (19.4)	9.3 (20.5)	8.6 (19)	9.1 (20.1)	8.4 (18.5)	8.9 (19.6)	8.2 (18.1)	8.7 (19.2)	
32 (104'12")	7.9 (17.4)	8.4 (18.5)	7.7 (17)	8.2 (18.1)	7.5 (16.5)	8.0 (17.6)	7.3 (16.1)	7.7 (17)	
34 (111'7")	7.1 (15.7)	7.5 (16.5)	6.9 (15.2)	7.3 (16.1)	6.7 (14.8)	7.1 (15.7)	6.5 (14.3)	6.9 (15.2)	
36 (118'1")	6.4 (14.1)	6.8 (15)	6.2 (13.7)	6.6 (14.6)	6.0 (13.2)	6.4 (14.1)	5.8 (12.8)	6.1 (13.4)	
38 (124'8")	5.8 (12.8)	6.1 (13.4)	5.6 (12.3)	5.9 (13)	5.4 (11.9)	5.7 (12.6)	5.1 (11.2)	5.4 (11.9)	
40 (131'3")	5.2 (11.5)	5.5 (12.1)	4.9 (10.8)	5.2 (11.5)	4.6 (10.1)	4.9 (10.8)	4.3 (9.5)	4.6 (10.1)	
42 (137'10")	4.6 (10.1)	4.9 (10.8)	4.3 (9.5)	4.6 (10.1)	4.1 (9)	4.3 (9.5)	3.8 (8.4)	4.0 (8.8)	
44 (144'4")	4.1 (9)	4.3 (9.5)	3.8 (8.4)	4.0 (8.8)	3.5 (7.7)	3.7 (8.2)	3.2 (7.1)	3.4 (7.5)	
46 (150'11")	3.6 (7.9)	3.8 (8.4)	3.3 (7.3)	3.5 (7.7)	3.1 (6.8)	3.3 (7.3)	2.8 (6.2)	3.0 (6.6)	
48 (157'6")	3.2 (7.1)	3.4 (7.5)	2.9 (6.4)	3.1 (6.8)	2.6 (5.7)	2.8 (6.2)	2.3 (5.1)	2.4 (5.3)	
50 (164'0")	2.8 (6.2)	3.0 (6.6)	2.5 (5.5)	2.7 (6)	2.3 (5.1)	2.4 (5.3)	2.0 (4.4)	2.1 (4.6)	
52 (170'7")	2.4 (5.3)	2.5 (5.5)	2.1 (4.6)	2.2 (4.9)	2.0 (4.4)	2.1 (4.6)	1.8 (4)	1.9 (4.2)	
Counterweight kg(lb)×1000	42 (92.6)	42+3 (92.6+6.6)	42 (92.6)	42+3 (92.6+6.6)	42 (92.6)	42+3 (92.6+6.6)	42 (92.6)	42+3 (92.6+6.6)	
Multiplying factor	3		3		3		3		

- Notes: 1. Actual hoisting capacity is rated multiplying factor in the table minus weight of hoisting hook and all hoisting tools.
 2. Rated load indicated in the table is weight hoisted by the crane on horizontal and hard ground surface.
 3. Cells 40% grayed and italicized indicate that the operating condition is with both the standard counterweight and additional counterweight; and cells framed and grayed indicate that the lifting capacity depends on strength of boom system.
 4. To prevent retroversion, a boom frame longer than 39m (127'11") should be connected before placing additional counterweight. Additional counterweight is strictly forbidden with boom frame shorter than 39m(127'11").

Load Charts of H Operating Condition

Notes--Rated Load of the Crane

1. Rated loads in the load charts are calculated as 75% of the tipping load.
2. All rated loads listed in the load charts are all applicable to the whole 360° rotation.
3. Operating condition with additional counterweight (42,000kg+3,000kg) (92,600lb+6,620lb) is optional, not standard. Booms that are allowed to install with additional counterweight range from 39m(127'11") to 72m(236'3").

Operating Range Diagram

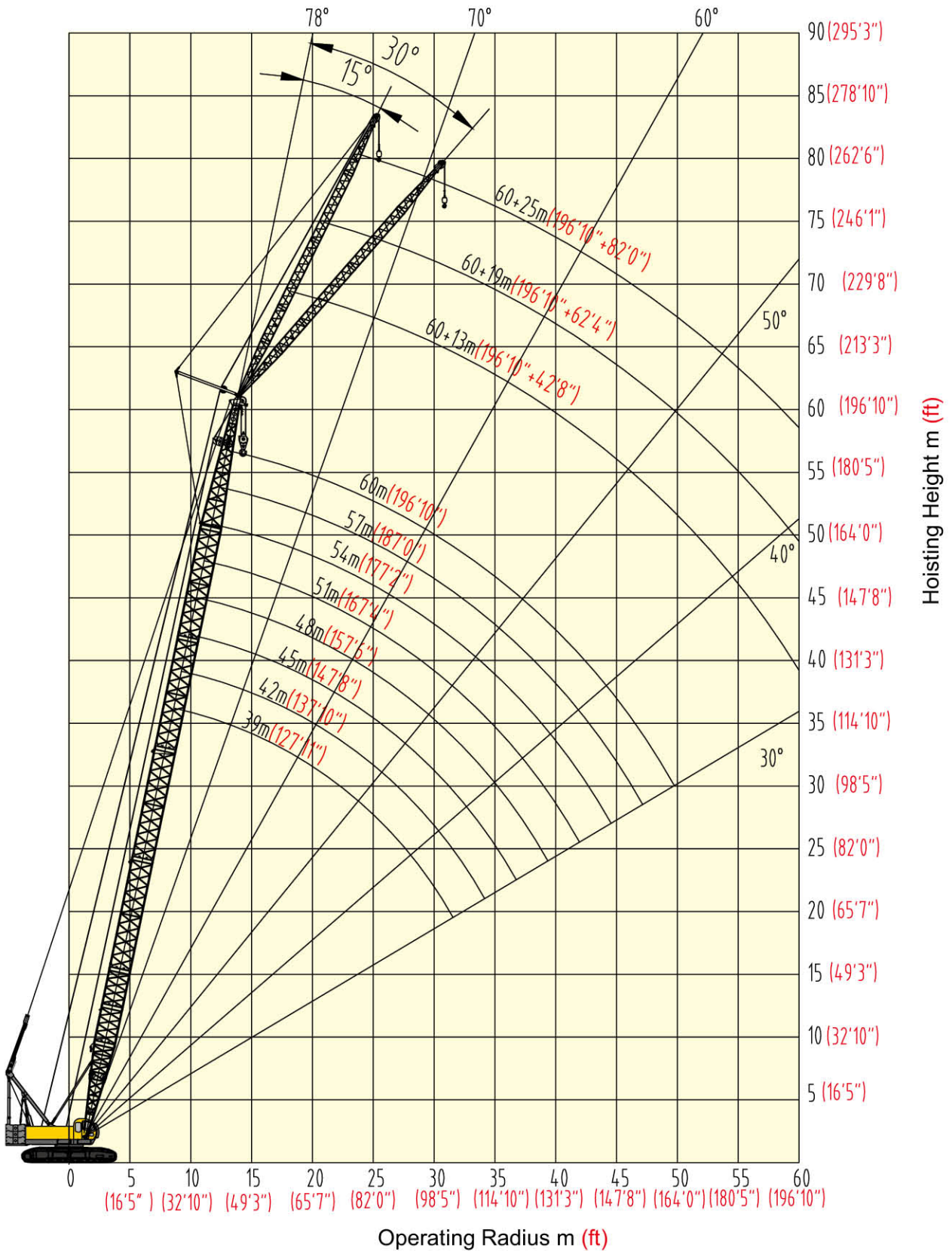

Hoisting Height and Operating Range Diagram

Combination of Jib

Jib Length (m) (ft)	Jib Insert		Boom Length(m) (ft)	Jib Offset Angle
	3 m (9' 10")	6 m (19' 8")		
13 (42' 8")	1	-	39 ~ 63 (127' 11" ~206' 8")	15° , 30°
19 (62' 4")	1	1	39 ~ 63 (127' 11" ~206' 8")	15° , 30°
25 (82')	1	2	39 ~ 60 (127' 11" ~196' 10")	15° , 30°

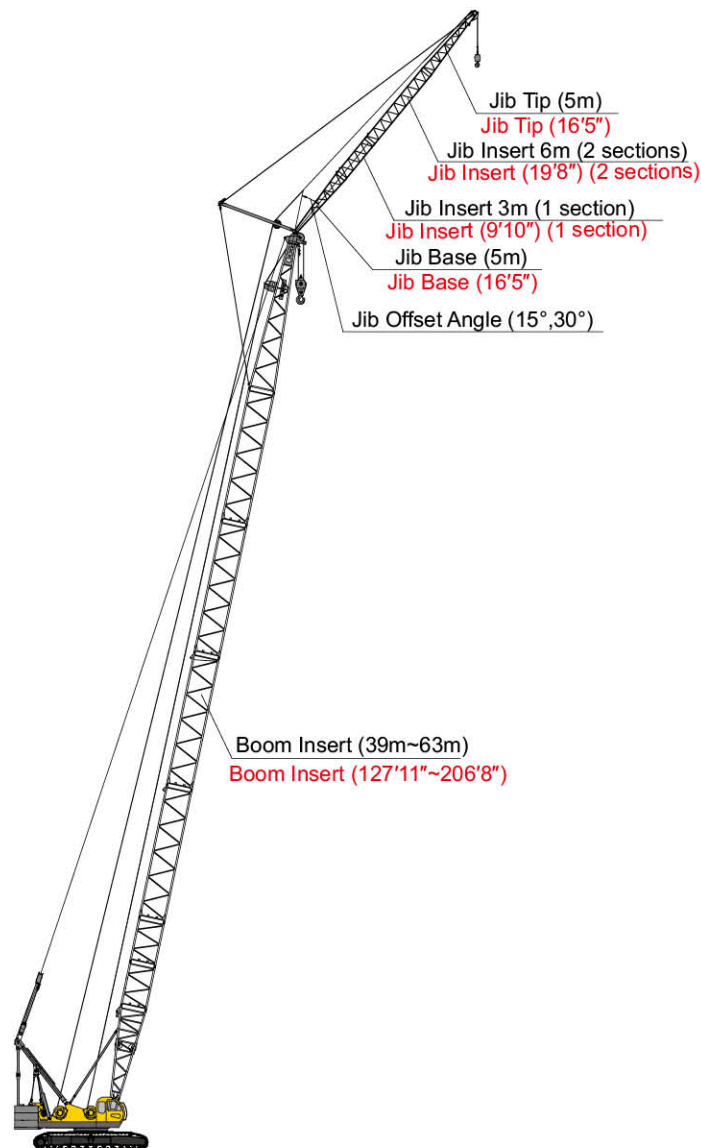

Combination of Jib 13m(42' 8"), 19m(62' 4"), 25m(82')

Load Charts of FJ Operating Condition

Fixed Jib Load Charts 1/10									kg(lb)×1000
Main Boom Length m (ft)	39m (127'11")								
Fixed Jib Length m (ft)	13m (42'8")				19m (62'4")				
Jib Angle	15°		30°		15°		30°		
Radius m (ft)	15°		30°		15°		30°		
14m (45'11")	14.3/11.0 (46'11"/24.3)	14.3/11.5 (46'11"/25.4)							
16m (52'6")	11.0 (24.3)	11.5 (25.4)	17.2/8.0 (56'5"/17.6)	17.2/8.4 (56'5"/18.5)	17.2/7.2 (56'5"/15.9)	17.2/7.5 (56'5"/16.5)			
18m (59'1")	11.0 (24.3)	11.5 (25.4)	8.0 (17.6)	8.4 (18.5)	7.2 (15.9)	7.5 (16.5)			
20m (65'7")	11.0 (24.3)	11.5 (25.4)	8.0 (17.6)	8.4 (18.5)	7.2 (15.9)	7.5 (16.5)	21.1/5.7 (69'3"/12.6)	21.1/6.0 (69'3"/13.2)	
22m (72'2")	11.0 (24.3)	11.5 (25.4)	8.0 (17.6)	8.4 (18.5)	7.2 (15.9)	7.5 (16.5)	5.7 (12.6)	6.0 (13.2)	
24m (78'9")	11.0 (24.3)	11.5 (25.4)	8.0 (17.6)	8.4 (18.5)	7.2 (15.9)	7.5 (16.5)	5.7 (12.6)	6.0 (13.2)	
26m (85'4")	11.0 (24.3)	11.5 (25.4)	8.0 (17.6)	8.4 (18.5)	7.2 (15.9)	7.5 (16.5)	5.7 (12.6)	6.0 (13.2)	
28m (91'10")	29.0/11.0 (95'2"/24.3)	29.0/11.5 (95'2"/25.4)	8.0 (17.6)	8.4 (18.5)	7.2 (15.9)	7.5 (16.5)	5.7 (12.6)	6.0 (13.2)	
30m (98'5")	10.6 (23.4)	11.1 (24.5)	8.0 (17.6)	8.4 (18.5)	7.2 (15.9)	7.5 (16.5)	5.7 (12.6)	6.0 (13.2)	
32m (104'12")	10.0 (22)	10.5 (23.1)	8.0 (17.6)	8.4 (18.5)	7.2 (15.9)	7.5 (16.5)	5.7 (12.6)	6.0 (13.2)	
34m (111'7")	9.4 (20.7)	9.8 (21.6)	8.0 (17.6)	8.4 (18.5)	7.2 (15.9)	7.5 (16.5)	5.7 (12.6)	6.0 (13.2)	
36m (118'1")	34.7/9.4 (113'10"/20.7)	34.7/9.8 (113'10"/21.6)	34.7/8.0 (113'10"/17.6)	34.7/8.4 (113'10"/18.5)	34.7/7.2 (113'10"/15.9)	34.7/7.5 (113'10"/16.5)	34.7/5.7 (113'10"/12.6)	34.7/6.0 (113'10"/13.2)	
Counterweight kg(lb)×1000	42 (92.6)	42+3 (92.6+6.6)	42 (92.6)	42+3 (92.6+6.6)	42 (92.6)	42+3 (92.6+6.6)	42 (92.6)	42+3 (92.6+6.6)	

Main Boom Length m (ft)	39m (127'11")				42m (137'10")			
Fixed Jib Length m (ft)	25m (82'0")				13m (42'8")			
Jib Angle	15°		30°		15°		30°	
Radius m (ft)	15°		30°		15°		30°	
14m (45'11")					14.9/11.0 (48'11"/24.3)	14.9/11.5 (48'11"/25.4)		
16m (52'6")					11.0 (24.3)	11.5 (25.4)		
18m (59'1")	19.5/4.6 (63'12"/10.1)	19.5/4.8 (63'12"/10.6)			11.0 (24.3)	11.5 (25.4)	18.2/8.0 (59'9"/17.6)	18.2/8.4 (59'9"/18.5)
20m (65'7")	4.6 (10.1)	4.8 (10.6)			11.0 (24.3)	11.5 (25.4)	8.0 (17.6)	8.4 (18.5)
22m (72'2")	4.6 (10.1)	4.8 (10.6)			11.0 (24.3)	11.5 (25.4)	8.0 (17.6)	8.4 (18.5)
24m (78'9")	4.6 (10.1)	4.8 (10.6)	25.1/3.9 (82'4"/8.6)	25.1/4.1 (82'4"/9)	11.0 (24.3)	11.5 (25.4)	8.0 (17.6)	8.4 (18.5)
26m (85'4")	4.6 (10.1)	4.8 (10.6)	3.9 (8.6)	4.1 (9)	11.0 (24.3)	11.5 (25.4)	8.0 (17.6)	8.4 (18.5)
28m (91'10")	4.6 (10.1)	4.8 (10.6)	3.9 (8.6)	4.1 (9)	11.0 (24.3)	11.5 (25.4)	8.0 (17.6)	8.4 (18.5)
30m (98'5")	4.6 (10.1)	4.8 (10.6)	3.9 (8.6)	4.1 (9)	11.0 (24.3)	11.5 (25.4)	8.0 (17.6)	8.4 (18.5)
32m (104'12")	4.6 (10.1)	4.8 (10.6)	3.9 (8.6)	4.1 (9)	10.3 (22.7)	10.8 (23.8)	8.0 (17.6)	8.4 (18.5)
34m (111'7")	4.6 (10.1)	4.8 (10.6)	3.9 (8.6)	4.1 (9)	9.3 (20.5)	9.7 (21.4)	8.0 (17.6)	8.4 (18.5)
36m (118'1")	34.7/4.6 (113'10"/10.1)	34.7/4.8 (113'10"/10.6)	34.7/3.9 (113'10"/8.6)	34.7/4.1 (113'10"/9)	8.4 (18.5)	8.8 (19.4)	8.0 (17.6)	8.4 (18.5)
38m (124'8")					37.1/8.2 (121'9"/18.1)	37.1/8.6 (121'9"/19)	37.1/8.0 (121'9"/17.6)	37.1/8.4 (121'9"/18.5)
Counterweight kg(lb)×1000	42 (92.6)	42+3 (92.6+6.6)	42 (92.6)	42+3 (92.6+6.6)	42 (92.6)	42+3 (92.6+6.6)	42 (92.6)	42+3 (92.6+6.6)

- Notes:
- Actual hoisting capacity is rated multiplying factor in the table minus weight of hoisting hook and all hoisting tools.
 - Rated load indicated in the table is weight hoisted by the crane on horizontal and hard ground surface.
 - Cells 40% grayed and italicized indicate that the operating condition is with both the standard counterweight and additional counterweight; and cells framed and grayed indicate that the lifting capacity depends on strength of boom system.
 - To prevent retroversion, a boom frame longer than 39m (127'11") should be connected before placing additional counterweight. Additional counterweight is strictly forbidden with boom frame shorter than 39m (127'11").

Load Charts of FJ Operating Condition

Fixed Jib Load Charts 2/10								kg(lb)×1000	
Main Boom	42m								
Length m (ft)	(137'10")								
Fixed Jib	19m			25m					
Length m (ft)	(62'4")			(82'0")					
Jib Angle	15°		30°		15°		30°		
Radius m(ft)									
16m (52'6")	17.6/7.2 (57'9"/15.9)	17.6/7.5 (57'9"/16.5)							
18m (59'1")	7.2 (15.9)	7.5 (16.5)							
20m (65'7")	7.2 (15.9)	7.5 (16.5)	21.5/5.7 (70'6"/12.6)	21.5/6.0 (70'6"/13.2)	20.1/4.6 (65'11"/10.1)	20.1/4.8 (65'11"/10.6)			
22m (72'2")	7.2 (15.9)	7.5 (16.5)	5.7 (12.6)	6.0 (13.2)	4.6 (10.1)	4.8 (10.6)			
24m (78'9")	7.2 (15.9)	7.5 (16.5)	5.7 (12.6)	6.0 (13.2)	4.6 (10.1)	4.8 (10.6)	25.4/3.9 (83'4"/8.6)	25.4/4.1 (83'4"/9)	
26m (85'4")	7.2 (15.9)	7.5 (16.5)	5.7 (12.6)	6.0 (13.2)	4.6 (10.1)	4.8 (10.6)	3.9 (8.6)	4.1 (9)	
28m (91'10")	7.2 (15.9)	7.5 (16.5)	5.7 (12.6)	6.0 (13.2)	4.6 (10.1)	4.8 (10.6)	3.9 (8.6)	4.1 (9)	
30m (98'5")	7.2 (15.9)	7.5 (16.5)	5.7 (12.6)	6.0 (13.2)	4.6 (10.1)	4.8 (10.6)	3.9 (8.6)	4.1 (9)	
32m (104'12")	7.2 (15.9)	7.5 (16.5)	5.7 (12.6)	6.0 (13.2)	4.6 (10.1)	4.8 (10.6)	3.9 (8.6)	4.1 (9)	
34m (111'7")	7.2 (15.9)	7.5 (16.5)	5.7 (12.6)	6.0 (13.2)	4.6 (10.1)	4.8 (10.6)	3.9 (8.6)	4.1 (9)	
36m (118'1")	7.2 (15.9)	7.5 (16.5)	5.7 (12.6)	6.0 (13.2)	4.6 (10.1)	4.8 (10.6)	3.9 (8.6)	4.1 (9)	
38m (124'8")	37.1/7.2 (121'9"/15.9)	37.1/7.5 (121'9"/16.5)	37.1/5.7 (121'9"/12.6)	37.1/6.0 (121'9"/13.2)	37.1/4.6 (121'9"/10.1)	37.1/4.8 (121'9"/10.6)	37.1/3.9 (121'9"/8.6)	37.1/4.1 (121'9"/9)	
Counterweight kg(lb)×1000	42 (92.6)	42+3 (92.6+6.6)	42 (92.6)	42+3 (92.6+6.6)	42 (92.6)	42+3 (92.6+6.6)	42 (92.6)	42+3 (92.6+6.6)	
Main Boom	45m								
Length m (ft)	(147'8")								
Fixed Jib	13m			19m					
Length m (ft)	(42'8")			(62'4")					
Jib Angle	15°		30°		15°		30°		
Radius m(ft)									
14m (45'11")	15.1/11.0 (49'6"/24.3)	15.1/11.5 (49'6"/25.4)							
16m (52'6")	11.0 (24.3)	11.5 (25.4)							
18m (59'1")	11.0 (24.3)	11.5 (25.4)	18.2/8.0 (59'9"/17.6)	18.2/8.4 (59'9"/18.5)	18.1/7.2 (59'5"/15.9)	18.1/7.5 (59'5"/16.5)			
20m (65'7")	11.0 (24.3)	11.5 (25.4)	8.0 (17.6)	8.4 (18.5)	7.2 (15.9)	7.5 (16.5)			
22m (72'2")	11.0 (24.3)	11.5 (25.4)	8.0 (17.6)	8.4 (18.5)	7.2 (15.9)	7.5 (16.5)	22.3/5.7 (73'2"/12.6)	22.3/6.0 (73'2"/13.2)	
24m (78'9")	11.0 (24.3)	11.5 (25.4)	8.0 (17.6)	8.4 (18.5)	7.2 (15.9)	7.5 (16.5)	5.7 (12.6)	6.0 (13.2)	
26m (85'4")	11.0 (24.3)	11.5 (25.4)	8.0 (17.6)	8.4 (18.5)	7.2 (15.9)	7.5 (16.5)	5.7 (12.6)	6.0 (13.2)	
28m (91'10")	11.0 (24.3)	11.5 (25.4)	8.0 (17.6)	8.4 (18.5)	7.2 (15.9)	7.5 (16.5)	5.7 (12.6)	6.0 (13.2)	
30m (98'5")	30.3/11.0 (99'5"/24.3)	30.3/11.5 (99'5"/25.4)	8.0 (17.6)	8.4 (18.5)	7.2 (15.9)	7.5 (16.5)	5.7 (12.6)	6.0 (13.2)	
32m (104'12")	10.2 (22.5)	10.7 (23.6)	8.0 (17.6)	8.4 (18.5)	7.2 (15.9)	7.5 (16.5)	5.7 (12.6)	6.0 (13.2)	
34m (111'7")	9.2 (20.3)	9.6 (21.2)	8.0 (17.6)	8.4 (18.5)	7.2 (15.9)	7.5 (16.5)	5.7 (12.6)	6.0 (13.2)	
36m (118'1")	8.4 (18.5)	8.8 (19.4)	36.8/8.0 (120'9"/17.6)	36.8/8.4 (120'9"/18.5)	7.2 (15.9)	7.5 (16.5)	5.7 (12.6)	6.0 (13.2)	
38m (124'8")	8.1 (17.9)	8.5 (18.7)	7.8 (17.2)	8.2 (18.1)	7.2 (15.9)	7.5 (16.5)	5.7 (12.6)	6.0 (13.2)	
40m (131'3")	7.5 (16.5)	7.8 (17.2)	7.4 (16.3)	7.7 (17)	7.2 (15.9)	7.5 (16.5)	5.7 (12.6)	6.0 (13.2)	
42m (137'10")	40.3/7.4 (132'3"/16.3)	40.3/7.7 (132'3"/17)	40.3/7.3 (132'3"/16.1)	40.3/7.6 (132'3"/16.8)	40.3/7.2 (132'3"/15.9)	40.3/7.5 (132'3"/16.5)	40.3/5.7 (132'3"/12.6)	40.3/6.0 (132'3"/13.2)	
Counterweight kg(lb)×1000	42 (92.6)	42+3 (92.6+6.6)	42 (92.6)	42+3 (92.6+6.6)	42 (92.6)	42+3 (92.6+6.6)	42 (92.6)	42+3 (92.6+6.6)	

SCC1000C Hydraulic Crawler Crane



- Notes:
1. Actual hoisting capacity is rated multiplying factor in the table minus weight of hoisting hook and all hoisting tools.
 2. Rated load indicated in the table is weight hoisted by the crane on horizontal and hard ground surface.
 3. Cells 40% grayed and italicized indicate that the operating condition is with both the standard counterweight and additional counterweight; and cells framed and grayed indicate that the lifting capacity depends on strength of boom system.
 4. To prevent retroversion, a boom frame longer than 39m (127'11") should be connected before placing additional counterweight. Additional counterweight is strictly forbidden with boom frame shorter than 39m(127'11").

Load Charts of FJ Operating Condition

Fixed Jib Load Charts 3/10								kg(lb)×1000	
Main Boom	45m				48m				
Length m (ft)	(147'8")				(157'6")				
Fixed Jib	25m				13m				
Length m (ft)	(82'0")				(42'8")				
Jib Angle	15°		30°		15°		30°		
Radius m (ft)									
16m (52'6")					15.9/11.0 (52'2"/24.3)	15.9/11.5 (52'2"/25.4)			
18m (59'1")					11.0 (24.3)	11.5 (25.4)	18.4/8.0 (60'4"/17.6)	18.4/8.4 (60'4"/18.5)	
20m (65'7")	20.7/4.6 (67'11"/10.1)	20.7/4.8 (67'11"/10.6)			11.0 (24.3)	11.5 (25.4)	8.0 (17.6)	8.4 (18.5)	
22m (72'2")	4.6 (10.1)	4.8 (5.3)			11.0 (24.3)	11.5 (25.4)	8.0 (17.6)	8.4 (18.5)	
24m (78'9")	4.6 (10.1)	4.8 (10.6)	25.9/3.9 (84'12"/8.6)	25.9/4.1 (84'12"/9)	11.0 (24.3)	11.5 (25.4)	8.0 (17.6)	8.4 (18.5)	
26m (85'4")	4.6 (10.1)	4.8 (10.6)	3.9 (8.6)	4.1 (9)	11.0 (24.3)	11.5 (25.4)	8.0 (17.6)	8.4 (18.5)	
28m (91'10")	4.6 (10.1)	4.8 (10.6)	3.9 (8.6)	4.1 (9)	11.0 (24.3)	11.5 (25.4)	8.0 (17.6)	8.4 (18.5)	
30m (98'5")	4.6 (10.1)	4.8 (10.6)	3.9 (8.6)	4.1 (9)	30.1/11.0 (98'9"/24.3)	30.1/11.5 (98'9"/25.4)	8.0 (17.6)	8.4 (18.5)	
32m (104'12")	4.6 (10.1)	4.8 (10.6)	3.9 (8.6)	4.1 (9)	10.1 (22.3)	10.6 (23.4)	8.0 (17.6)	8.4 (18.5)	
34m (111'7")	4.6 (10.1)	4.8 (10.6)	3.9 (8.6)	4.1 (9)	9.1 (20.1)	9.5 (20.9)	8.0 (17.6)	8.4 (18.5)	
36m (118'1")	4.6 (10.1)	4.8 (10.6)	3.9 (8.6)	4.1 (9)	8.2 (18.1)	8.6 (19)	8.0 (17.6)	8.4 (18.5)	
38m (124'8")	4.6 (10.1)	4.8 (10.6)	3.9 (8.6)	4.1 (9)	8.0 (17.6)	8.4 (18.5)	7.4 (16.3)	7.7 (17)	
40m (131'3")	4.6 (10.1)	4.8 (10.6)	3.9 (8.6)	4.1 (9)	7.3 (16.1)	7.6 (16.8)	7.3 (16.1)	7.6 (16.8)	
42m (137'10")	40.3/4.6 (132'3"/10.1)	40.3/4.8 (132'3"/10.6)	40.3/3.9 (132'3"/8.6)	40.3/4.1 (132'3"/9)	7.1 (15.7)	7.4 (16.3)	7.1 (15.7)	7.4 (16.3)	
44m (144'4")					42.8/6.9 (140'5"/15.2)	42.8/7.2 (140'5"/15.9)	42.8/6.8 (140'5"/15)	42.8/7.1 (140'5"/15.7)	
Counterweight kg (lb) ×1000	42 (92.6)	42+3 (92.6+6.6)	42 (92.6)	42+3 (92.6+6.6)	42 (92.6)	42+3 (92.6+6.6)	42 (92.6)	42+3 (92.6+6.6)	
Main Boom	48m								
Length m (ft)	(157'6")								
Fixed Jib	19m				25m				
Length m (ft)	(62'4")				(82'0")				
Jib Angle	15°		30°		15°		30°		
Radius m (ft)									
18m (59'1")	18.2/7.2 (59'9"/15.9)	18.2/7.5 (59'9"/16.5)							
20m (65'7")	7.2 (15.9)	7.5 (16.5)			21.2/4.6 (69'7"/10.1)	21.2/4.8 (69'7"/10.6)			
22m (72'2")	7.2 (15.9)	7.5 (16.5)	22.7/5.7 (74'6"/12.6)	22.7/6.0 (74'6"/13.2)	4.6 (10.1)	4.8 (10.6)			
24m (78'9")	7.2 (15.9)	7.5 (16.5)	5.7 (12.6)	6.0 (13.2)	4.6 (10.1)	4.8 (10.6)			
26m (85'4")	7.2 (15.9)	7.5 (16.5)	5.7 (12.6)	6.0 (13.2)	4.6 (10.1)	4.8 (10.6)	26.5/3.9 (86'11"/8.6)	26.5/4.1 (86'11"/9)	
28m (91'10")	7.2 (15.9)	7.5 (16.5)	5.7 (12.6)	6.0 (13.2)	4.6 (10.1)	4.8 (10.6)	3.9 (8.6)	4.1 (9)	
30m (98'5")	7.2 (15.9)	7.5 (16.5)	5.7 (12.6)	6.0 (13.2)	4.6 (10.1)	4.8 (10.6)	3.9 (8.6)	4.1 (9)	
32m (104'12")	7.2 (15.9)	7.5 (16.5)	5.7 (12.6)	6.0 (13.2)	4.6 (10.1)	4.8 (10.6)	3.9 (8.6)	4.1 (9)	
34m (111'7")	7.2 (15.9)	7.5 (16.5)	5.7 (12.6)	6.0 (13.2)	4.6 (10.1)	4.8 (10.6)	3.9 (8.6)	4.1 (9)	
36m (118'1")	7.2 (15.9)	7.5 (16.5)	5.7 (12.6)	6.0 (13.2)	4.6 (10.1)	4.8 (10.6)	3.9 (8.6)	4.1 (9)	
38m (124'8")	7.2 (15.9)	7.5 (16.5)	5.7 (12.6)	6.0 (13.2)	4.6 (10.1)	4.8 (10.6)	3.9 (8.6)	4.1 (9)	
40m (131'3")	7.2 (15.9)	7.5 (16.5)	5.7 (12.6)	6.0 (13.2)	4.6 (10.1)	4.8 (10.6)	3.9 (8.6)	4.1 (9)	
42m (137'10")	7.0 (15.4)	7.3 (16.1)	5.7 (12.6)	6.0 (13.2)	4.6 (10.1)	4.8 (10.6)	3.9 (8.6)	4.1 (9)	
44m (144'4")	42.8/6.7 (140'5"/14.8)	42.8/7.0 (140'5"/15.4)	42.8/5.7 (140'5"/12.6)	42.8/6.0 (140'5"/13.2)	42.8/4.6 (140'5"/10.1)	42.8/4.8 (140'5"/10.6)	42.8/3.9 (140'5"/8.6)	42.8/4.1 (140'5"/9)	
Counterweight kg (lb) ×1000	42 (92.6)	42+3 (92.6+6.6)	42 (92.6)	42+3 (92.6+6.6)	42 (92.6)	42+3 (92.6+6.6)	42 (92.6)	42+3 (92.6+6.6)	

- Notes:
1. Actual hoisting capacity is rated multiplying factor in the table minus weight of hoisting hook and all hoisting tools.
 2. Rated load indicated in the table is weight hoisted by the crane on horizontal and hard ground surface.
 3. Cells 40% grayed and italicized indicate that the operating condition is with both the standard counterweight and additional counterweight; and cells framed and grayed indicate that the lifting capacity depends on strength of boom system.
 4. To prevent retroversion, a boom frame longer than 39m (127'11") should be connected before placing additional counterweight. Additional counterweight is strictly forbidden with boom frame shorter than 39m (127'11").

Load Charts of FJ Operating Condition

Fixed Jib Load Charts 4/10								kg(lb)×1000	
Main Boom Length m (ft)	51m (167'4")								
	13m (42'8")				19m (62'4")				
Fixed Jib Length m (ft)	15°		30°		15°		30°		
	Radius m (ft)		Radius m (ft)		Radius m (ft)		Radius m (ft)		
16m (52'6")	16.3/11.0 (53'6"/24.3)	16.3/11.5 (53'6"/25.4)							
18m (59'1")	11.0 (24.3)	11.5 (25.4)	19.1/8.0 (62'8"/17.6)	19.1/8.4 (62'8"/18.5)	18.7/7.2 (61'4"/15.9)	18.7/7.5 (61'4"/16.5)			
20m (65'7")	11.0 (24.3)	11.5 (25.4)	8.0 (17.6)	8.4 (18.5)	7.2 (15.9)	7.5 (16.5)			
22m (72'2")	11.0 (24.3)	11.5 (25.4)	8.0 (17.6)	8.4 (18.5)	7.2 (15.9)	7.5 (16.5)	23.4/5.7 (76'9"/12.6)	23.4/6.0 (76'9"/13.2)	
24m (78'9")	11.0 (24.3)	11.5 (25.4)	8.0 (17.6)	8.4 (18.5)	7.2 (15.9)	7.5 (16.5)	5.7 (12.6)	6.0 (13.2)	
26m (85'4")	11.0 (24.3)	11.5 (25.4)	8.0 (17.6)	8.4 (18.5)	7.2 (15.9)	7.5 (16.5)	5.7 (12.6)	6.0 (13.2)	
28m (91'10")	11.0 (24.3)	11.5 (25.4)	8.0 (17.6)	8.4 (18.5)	7.2 (15.9)	7.5 (16.5)	5.7 (12.6)	6.0 (13.2)	
30m (98'5")	29.6/11.0 (97'1"/24.3)	29.6/11.5 (97'1"/25.4)	8.0 (17.6)	8.4 (18.5)	7.2 (15.9)	7.5 (16.5)	5.7 (12.6)	6.0 (13.2)	
32m (104'12")	9.9 (21.8)	10.3 (22.7)	8.0 (17.6)	8.4 (18.5)	7.2 (15.9)	7.5 (16.5)	5.7 (12.6)	6.0 (13.2)	
34m (111'7")	9.0 (19.8)	9.4 (20.7)	8.0 (17.6)	8.4 (18.5)	7.2 (15.9)	7.5 (16.5)	5.7 (12.6)	6.0 (13.2)	
36m (118'1")	8.1 (17.9)	8.5 (18.7)	36.2/8.0 (118'9"/17.6)	36.2/8.4 (118'9"/18.5)	7.2 (15.9)	7.5 (16.5)	5.7 (12.6)	6.0 (13.2)	
38m (124'8")	8.0 (17.6)	8.4 (18.5)	7.3 (16.1)	7.6 (16.8)	7.2 (15.9)	7.5 (16.5)	5.7 (12.6)	6.0 (13.2)	
40m (131'3")	7.2 (15.9)	7.5 (16.5)	7.1 (15.7)	7.4 (16.3)	40.9/7.2 (134'2"/15.9)	40.9/7.5 (134'2"/16.5)	5.7 (12.6)	6.0 (13.2)	
42m (137'10")	6.9 (15.2)	7.2 (15.9)	6.9 (15.2)	7.2 (15.9)	6.8 (15)	7.1 (15.7)	5.7 (12.6)	6.0 (13.2)	
44m (144'4")	6.7 (14.8)	7.0 (15.4)	6.7 (14.8)	7.0 (15.4)	6.6 (14.6)	6.9 (15.2)	5.7 (12.6)	6.0 (13.2)	
46m (150'11")	44.6/6.2 (146'4"/13.7)	44.6/6.5 (146'4"/14.3)	44.6/6.2 (146'4"/13.7)	44.6/6.5 (146'4"/14.3)	44.6/6.1 (146'4"/13.4)	44.6/6.4 (146'4"/14.1)	44.6/5.7 (146'4"/12.6)	44.6/6.0 (146'4"/13.2)	
Counterweight kg(lb) ×1000	42 (92.6)	42+3 (92.6+6.6)	42 (92.6)	42+3 (92.6+6.6)	42 (92.6)	42+3 (92.6+6.6)	42 (92.6)	42+3 (92.6+6.6)	

- Notes: 1. Actual hoisting capacity is rated multiplying factor in the table minus weight of hoisting hook and all hoisting tools.
 2. Rated load indicated in the table is weight hoisted by the crane on horizontal and hard ground surface.
 3. Cells 40% grayed and italicized indicate that the operating condition is with both the standard counterweight and additional counterweight; and cells framed and grayed indicate that the lifting capacity depends on strength of boom system.
 4. To prevent retroversion, a boom frame longer than 39m (127'11") should be connected before placing additional counterweight. Additional counterweight is strictly forbidden with boom frame shorter than 39m(127'11").

Load Charts of FJ Operating Condition

Fixed Jib Load Charts 5/10								kg(lb)×1000	
Main Boom Length m (ft)	51m (167'4")				54m (177'2")				
Fixed Jib Length m (ft)	25m (82'0")				13m (42'8")				
Jib Angle Radius m (ft)	15°		30°		15°		30°		
16m (52'6")					17.1/11.0 (56'1"/24.3)	17.1/11.5 (56'1"/25.4)			
18m (59'1")					11.0 (24.3)	11.5 (25.4)			
20m (65'7")					11.0 (24.3)	11.5 (25.4)	20.1/8.0 (65'11"/17.6)	20.1/8.4 (65'11"/18.5)	
22m (72'2")	21.9/4.6 (71'10"/10.1)	21.9/4.8 (71'10"/10.6)	21.5/3.9 (70'6"/8.6)	21.5/4.1 (70'6"/9)	11.0 (24.3)	11.5 (25.4)	8.0 (17.6)	8.4 (18.5)	
24m (78'9")	4.6 (10.1)	4.8 (10.6)	3.9 (8.6)	4.1 (9)	11.0 (24.3)	11.5 (25.4)	8.0 (17.6)	8.4 (18.5)	
26m (85'4")	4.6 (10.1)	4.8 (10.6)	3.9 (8.6)	4.1 (9)	11.0 (24.3)	11.5 (25.4)	8.0 (17.6)	8.4 (18.5)	
28m (91'10")	4.6 (10.1)	4.8 (10.6)	3.9 (8.6)	4.1 (9)	11.0 (24.3)	11.5 (25.4)	8.0 (17.6)	8.4 (18.5)	
30m (98'5")	4.6 (10.1)	4.8 (10.6)	3.9 (8.6)	4.1 (9)	11.0 (24.3)	11.5 (25.4)	8.0 (17.6)	8.4 (18.5)	
32m (104'12")	4.6 (10.1)	4.8 (10.6)	3.9 (8.6)	4.1 (9)	9.8 (21.6)	10.2 (22.5)	8.0 (17.6)	8.4 (18.5)	
34m (111'7")	4.6 (10.1)	4.8 (10.6)	3.9 (8.6)	4.1 (9)	8.9 (19.6)	9.3 (20.5)	8.0 (17.6)	8.4 (18.5)	
36m (118'1")	4.6 (10.1)	4.8 (10.6)	3.9 (8.6)	4.1 (9)	8.1 (17.9)	8.5 (18.7)	8.0 (17.6)	8.4 (18.5)	
38m (124'8")	4.6 (10.1)	4.8 (10.6)	3.9 (8.6)	4.1 (9)	8.0 (17.6)	8.4 (18.5)	7.2 (15.9)	7.5 (16.5)	
40m (131'3")	4.6 (10.1)	4.8 (10.6)	3.9 (8.6)	4.1 (9)	7.1 (15.7)	7.4 (16.3)	7.0 (15.4)	7.3 (16.1)	
42m (137'10")	4.6 (10.1)	4.8 (10.6)	3.9 (8.6)	4.1 (9)	6.7 (14.8)	7.0 (15.4)	6.6 (14.6)	6.9 (15.2)	
44m (144'4")	4.6 (10.1)	4.8 (10.6)	3.9 (8.6)	4.1 (9)	6.6 (14.6)	6.9 (15.2)	6.5 (14.3)	6.8 (15)	
46m (150'11")	44.6/4.6 (146'4"/10.1)	44.6/4.8 (146'4"/10.6)	44.6/3.9 (146'4"/8.6)	44.6/4.1 (146'4"/9)	6.1 (13.4)	6.4 (14.1)	6.1 (13.4)	6.4 (14.1)	
48m (157'6")					5.8 (12.8)	6.1 (13.4)	5.8 (12.8)	6.1 (13.4)	
50m (164'0")					48.1/5.7 (157'10"/12.6)	48.1/6.0 (157'10"/13.2)	48.1/5.7 (157'10"/12.6)	48.1/6.0 (157'10"/13.2)	
Counterweight kg(lb)×1000	42 (92.6)	42+3 (92.6+6.6)	42 (92.6)	42+3 (92.6+6.6)	42 (92.6)	42+3 (92.6+6.6)	42 (92.6)	42+3 (92.6+6.6)	

- Notes:
1. Actual hoisting capacity is rated multiplying factor in the table minus weight of hoisting hook and all hoisting tools.
 2. Rated load indicated in the table is weight hoisted by the crane on horizontal and hard ground surface.
 3. Cells 40% grayed and italicized indicate that the operating condition is with both the standard counterweight and additional counterweight; and cells framed and grayed indicate that the lifting capacity depends on strength of boom system.
 4. To prevent retroversion, a boom frame longer than 39m (127'11") should be connected before placing additional counterweight. Additional counterweight is strictly forbidden with boom frame shorter than 39m(127'11").

Load Charts of FJ Operating Condition

Fixed Jib Load Charts 6/10									kg(lb)×1000
Main Boom Length m (ft)	54m								
	(177'2")								
Fixed Jib Length m (ft)	19m				25m				
	(62'4")				(82'0")				
Jib Angle	15°		30°		15°		30°		
Radius m (ft)									
20m (65'7")	20.0/7.2 (65'7"/15.9)	20.0/7.5 (65'7"/16.5)							
22m (72'2")	7.2 (15.9)	7.5 (16.5)			22.3/4.6 (73'2"/10.1)	22.3/4.8 (73'2"/10.6)			
24m (78'9")	7.2 (15.9)	7.5 (16.5)	25.2/5.7 (82'8"/12.6)	25.2/6.0 (82'8"/13.2)	4.6 (10.1)	4.8 (10.6)			
26m (85'4")	7.2 (15.9)	7.5 (16.5)	5.7 (12.6)	6.0 (13.2)	4.6 (10.1)	4.8 (10.6)			
28m (91'10")	7.2 (15.9)	7.5 (16.5)	5.7 (12.6)	6.0 (13.2)	4.6 (10.1)	4.8 (10.6)	28.1/3.9 (92'2"/8.6)	28.1/4.1 (92'2"/9)	
30m (98'5")	7.2 (15.9)	7.5 (16.5)	5.7 (12.6)	6.0 (13.2)	4.6 (10.1)	4.8 (10.6)	3.9 (8.6)	4.1 (9)	
32m (104'12")	7.2 (15.9)	7.5 (16.5)	5.7 (12.6)	6.0 (13.2)	4.6 (10.1)	4.8 (10.6)	3.9 (8.6)	4.1 (9)	
34m (111'7")	7.2 (15.9)	7.5 (16.5)	5.7 (12.6)	6.0 (13.2)	4.6 (10.1)	4.8 (10.6)	3.9 (8.6)	4.1 (9)	
36m (118'1")	7.2 (15.9)	7.5 (16.5)	5.7 (12.6)	6.0 (13.2)	4.6 (10.1)	4.8 (10.6)	3.9 (8.6)	4.1 (9)	
38m (124'8")	37.8/7.2 (124'0"/15.9)	37.8/7.5 (124'0"/16.5)	5.7 (12.6)	6.0 (13.2)	4.6 (10.1)	4.8 (10.6)	3.9 (8.6)	4.1 (9)	
40m (131'3")	7.0 (15.4)	7.3 (16.1)	5.7 (12.6)	6.0 (13.2)	4.6 (10.1)	4.8 (10.6)	3.9 (8.6)	4.1 (9)	
42m (137'10")	6.5 (14.3)	6.8 (15)	5.7 (12.6)	6.0 (13.2)	4.6 (10.1)	4.8 (10.6)	3.9 (8.6)	4.1 (9)	
44m (144'4")	6.4 (14.1)	6.7 (14.8)	5.7 (12.6)	6.0 (13.2)	4.6 (10.1)	4.8 (10.6)	3.9 (8.6)	4.1 (9)	
46m (150'11")	6.1 (13.4)	6.4 (14.1)	5.7 (12.6)	6.0 (13.2)	4.6 (10.1)	4.8 (10.6)	3.9 (8.6)	4.1 (9)	
48m (157'6")	5.7 (12.6)	6.0 (13.2)	5.7 (12.6)	6.0 (13.2)	4.6 (10.1)	4.8 (10.6)	3.9 (8.6)	4.1 (9)	
50m (164'0")	48.1/5.7 (157'10"/12.6)	48.1/6.0 (157'10"/13.2)	48.1/5.7 (157'10"/12.6)	48.1/6.0 (157'10"/13.2)	48.1/4.6 (157'10"/10.1)	48.1/4.8 (157'10"/10.6)	48.1/3.9 (157'10"/8.6)	48.1/4.1 (157'10"/9)	
Counterweight	42	42+3	42	42+3	42	42+3	42	42+3	
kg (lb) ×1000	(92.6)	(92.6+6.6)	(92.6)	(92.6+6.6)	(92.6)	(92.6+6.6)	(92.6)	(92.6+6.6)	

- Notes: 1. Actual hoisting capacity is rated multiplying factor in the table minus weight of hoisting hook and all hoisting tools.
 2. Rated load indicated in the table is weight hoisted by the crane on horizontal and hard ground surface.
 3. Cells 40% grayed and italicized indicate that the operating condition is with both the standard counterweight and additional counterweight; and cells framed and grayed indicate that the lifting capacity depends on strength of boom system.
 4. To prevent retroversion, a boom frame longer than 39m (127'11") should be connected before placing additional counterweight. Additional counterweight is strictly forbidden with boom frame shorter than 39m(127'11").

Load Charts of FJ Operating Condition

Fixed Jib Load Charts 7/10									kg(lb)×1000
Main Boom Length m (ft)	57m (187'0")								
Fixed Jib Length m (ft)	13m (42'8")				19m (62'4")				
Jib Angle Radius m (ft)	15°		30°		15°		30°		
18m (59'1")	18.3/11.0 (60'0"/24.3)	18.3/11.5 (60'0"/25.4)							
20m (65'7")	11.0 (24.3)	11.5 (25.4)	20.6/8.0 (67'7"/17.6)	20.6/8.4 (67'7"/18.5)	20.4/7.2 (66'11"/15.9)	20.4/7.5 (66'11"/16.5)			
22m (72'2")	11.0 (24.3)	11.5 (25.4)	8.0 (17.6)	8.4 (18.5)	7.2 (15.9)	7.5 (16.5)			
24m (78'9")	11.0 (24.3)	11.5 (25.4)	8.0 (17.6)	8.4 (18.5)	7.2 (15.9)	7.5 (16.5)	24.6/5.7 (80'8"/12.6)	24.6/6.0 (80'8"/13.2)	
26m (85'4")	11.0 (24.3)	11.5 (25.4)	8.0 (17.6)	8.4 (18.5)	7.2 (15.9)	7.5 (16.5)	5.7 (12.6)	6.0 (13.2)	
28m (91'10")	29.3/11.0 (96'2"/24.3)	29.3/11.5 (96'2"/25.4)	8.0 (17.6)	8.4 (18.5)	7.2 (15.9)	7.5 (16.5)	5.7 (12.6)	6.0 (13.2)	
30m (98'5")	9.7 (21.4)	10.1 (22.3)	8.0 (17.6)	8.4 (18.5)	7.2 (15.9)	7.5 (16.5)	5.7 (12.6)	6.0 (13.2)	
32m (104'12")	9.5 (20.9)	9.9 (21.8)	8.0 (17.6)	8.4 (18.5)	7.2 (15.9)	7.5 (16.5)	5.7 (12.6)	6.0 (13.2)	
34m (111'7")	8.7 (19.2)	9.1 (20.1)	8.0 (17.6)	8.4 (18.5)	7.2 (15.9)	7.5 (16.5)	5.7 (12.6)	6.0 (13.2)	
36m (118'1")	8.0 (17.6)	8.4 (18.5)	37.1/8.0 (121'9"/17.6)	37.1/8.4 (121'9"/18.5)	7.2 (15.9)	7.5 (16.5)	5.7 (12.6)	6.0 (13.2)	
38m (124'8")	7.8 (17.2)	8.2 (18.1)	7.2 (15.9)	7.5 (16.5)	38.7/7.2 (126'12"/15.9)	38.7/7.5 (126'12"/16.5)	5.7 (12.6)	6.0 (13.2)	
40m (131'3")	7.0 (15.4)	7.3 (16.1)	6.8 (15)	7.1 (15.7)	7.0 (15.4)	7.3 (16.1)	5.7 (12.6)	6.0 (13.2)	
42m (137'10")	6.5 (14.3)	6.8 (15)	6.4 (14.1)	6.7 (14.8)	6.2 (13.7)	6.5 (14.3)	5.7 (12.6)	6.0 (13.2)	
44m (144'4")	6.4 (14.1)	6.7 (14.8)	6.3 (13.9)	6.6 (14.6)	6.1 (13.4)	6.4 (14.1)	5.7 (12.6)	6.0 (13.2)	
46m (150'11")	6.0 (13.2)	6.3 (13.9)	6.0 (13.2)	6.3 (13.9)	6.0 (13.2)	6.3 (13.9)	47.1/5.7 (154'6"/12.6)	47.1/6.0 (154'6"/13.2)	
48m (157'6")	5.7 (12.6)	6.0 (13.2)	5.7 (12.6)	6.0 (13.2)	5.6 (12.3)	5.9 (13)	5.5 (12.1)	5.8 (12.8)	
50m (164'0")	5.5 (12.1)	5.7 (12.6)	5.4 (11.9)	5.6 (12.3)	5.3 (11.7)	5.5 (12.1)	5.2 (11.5)	5.5 (12.1)	
52m (170'7")	50.5/5.1 (165'8"/11.2)	50.5/5.3 (165'8"/11.7)	50.5/5.0 (165'8"/11)	50.5/5.2 (165'8"/11.5)	50.5/4.9 (165'8"/10.8)	50.5/5.1 (165'8"/11.2)	50.5/4.8 (165'8"/10.6)	50.5/5.1 (165'8"/11.2)	
Counterweight kg(lb)×1000	42 (92.6)	42+3 (92.6+6.6)	42 (92.6)	42+3 (92.6+6.6)	42 (92.6)	42+3 (92.6+6.6)	42 (92.6)	42+3 (92.6+6.6)	

- Notes:
1. Actual hoisting capacity is rated multiplying factor in the table minus weight of hoisting hook and all hoisting tools.
 2. Rated load indicated in the table is weight hoisted by the crane on horizontal and hard ground surface.
 3. Cells 40% grayed and italicized indicate that the operating condition is with both the standard counterweight and additional counterweight; and cells framed and grayed indicate that the lifting capacity depends on strength of boom system.
 4. To prevent retroversion, a boom frame longer than 39m (127'11") should be connected before placing additional counterweight. Additional counterweight is strictly forbidden with boom frame shorter than 39m(127'11").

Load Charts of FJ Operating Condition

Fixed Jib Load Charts 8/10								kg(lb)×1000	
Main Boom Length m (ft)	57m (187'0")				60m (196'10")				
Fixed Jib Length m (ft)	25m (82'0")				13m (42'8")				
Jib Angle	15°		30°		15°		30°		
Radius m (ft)									
18m (59'1")					18.2/11.0 (59'9"/24.3)	18.2/11.5 (59'9"/25.4)			
20m (65'7")					11.0 (24.3)	11.5 (25.4)	21.2/8.0 (69'7"/17.6)	21.2/8.4 (69'7"/18.5)	
22m (72'2")	23.1/4.6 (75'9"/10.1)	23.1/4.8 (75'9"/10.6)			11.0 (24.3)	11.5 (25.4)	8.0 (17.6)	8.4 (18.5)	
24m (78'9")	4.6 (10.1)	4.8 (10.6)			11.0 (24.3)	11.5 (25.4)	8.0 (17.6)	8.4 (18.5)	
26m (85'4")	4.6 (10.1)	4.8 (10.6)			11.0 (24.3)	11.5 (25.4)	8.0 (17.6)	8.4 (18.5)	
28m (91'10")	4.6 (10.1)	4.8 (10.6)	28.2/3.9 (92'6"/8.6)	28.2/4.1 (92'6"/9)	29.7/11.0 (97'5"/24.3)	29.7/11.5 (97'5"/25.4)	8.0 (17.6)	8.4 (18.5)	
30m (98'5")	4.6 (10.1)	4.8 (10.6)	3.9 (8.6)	4.1 (9)	9.6 (21.2)	10.0 (22)	8.0 (17.6)	8.4 (18.5)	
32m (104'12")	4.6 (10.1)	4.8 (10.6)	3.9 (8.6)	4.1 (9)	9.4 (20.7)	9.8 (21.6)	8.0 (17.6)	8.4 (18.5)	
34m (111'7")	4.6 (10.1)	4.8 (10.6)	3.9 (8.6)	4.1 (9)	8.5 (18.7)	8.9 (19.6)	8.0 (17.6)	8.4 (18.5)	
36m (118'1")	4.6 (10.1)	4.8 (10.6)	3.9 (8.6)	4.1 (9)	8.0 (17.6)	8.4 (18.5)	36.3/8.0 (119'1"/17.6)	36.3/8.4 (119'1"/18.5)	
38m (124'8")	4.6 (10.1)	4.8 (10.6)	3.9 (8.6)	4.1 (9)	7.6 (16.8)	7.9 (17.4)	7.2 (15.9)	7.5 (16.5)	
40m (131'3")	4.6 (10.1)	4.8 (10.6)	3.9 (8.6)	4.1 (9)	6.9 (15.2)	7.2 (15.9)	6.7 (14.8)	7.0 (15.4)	
42m (137'10")	4.6 (10.1)	4.8 (10.6)	3.9 (8.6)	4.1 (9)	6.4 (14.1)	6.7 (14.8)	6.3 (13.9)	6.6 (14.6)	
44m (144'4")	4.6 (10.1)	4.8 (10.6)	3.9 (8.6)	4.1 (9)	6.2 (13.7)	6.5 (14.3)	6.1 (13.4)	6.4 (14.1)	
46m (150'11")	4.6 (10.1)	4.8 (10.6)	3.9 (8.6)	4.1 (9)	5.8 (12.8)	6.1 (13.4)	5.7 (12.6)	6.0 (13.2)	
48m (157'6")	4.6 (10.1)	4.8 (10.6)	3.9 (8.6)	4.1 (9)	5.5 (12.1)	5.7 (12.6)	5.4 (11.9)	5.6 (12.3)	
50m (164'0")	4.6 (10.1)	4.8 (10.6)	3.9 (8.6)	4.1 (9)	5.4 (11.9)	5.6 (12.3)	5.2 (11.5)	5.4 (11.9)	
52m (170'7")	50.5/4.6 (165'8"/10.1)	50.5/4.8 (165'8"/10.6)	50.5/3.9 (165'8"/8.6)	50.5/4.1 (165'8"/9)	5.0 (11)	5.2 (11.5)	4.9 (10.8)	5.1 (11.2)	
54m (177'2")					52.8/4.4 (173'3"/9.7)	52.8/4.6 (173'3"/10.1)	52.8/4.3 (173'3"/9.5)	52.8/4.5 (173'3"/9.9)	
Counterweight kg(lb)×1000	42 (92.6)	42+3 (92.6+6.6)	42 (92.6)	42+3 (92.6+6.6)	42 (92.6)	42+3 (92.6+6.6)	42 (92.6)	42+3 (92.6+6.6)	

- Notes:
1. Actual hoisting capacity is rated multiplying factor in the table minus weight of hoisting hook and all hoisting tools.
 2. Rated load indicated in the table is weight hoisted by the crane on horizontal and hard ground surface.
 3. Cells 40% grayed and italicized indicate that the operating condition is with both the standard counterweight and additional counterweight; and cells framed and grayed indicate that the lifting capacity depends on strength of boom system.
 4. To prevent retroversion, a boom frame longer than 39m (127'11") should be connected before placing additional counterweight. Additional counterweight is strictly forbidden with boom frame shorter than 39m(127'11").

Load Charts of FJ Operating Condition

Fixed Jib Load Charts 9/10									kg(lb)×1000
Main Boom Length m (ft)	60m (196'10")								
	19m (62'4")				25m (82'0")				
Fixed Jib Length m (ft)	15°		30°		15°		30°		
	Jib Angle		Jib Angle		Jib Angle		Jib Angle		
Radius m (ft)	15°		30°		15°		30°		
20m (65'7")	21.0/7.2 (68'11"/15.9)	21.0/7.5 (68'11"/16.5)							
22m (72'2")	7.2 (15.9)	7.5 (16.5)			23.5/4.6 (77'1"/10.1)	23.5/4.8 (77'1"/10.6)			
24m (78'9")	7.2 (15.9)	7.5 (16.5)	24.4/5.7 (80'1"/12.6)	24.4/6.0 (80'1"/13.2)	4.6 (10.1)	4.8 (10.6)			
26m (85'4")	7.2 (15.9)	7.5 (16.5)	5.7 (12.6)	6.0 (13.2)	4.6 (10.1)	4.8 (10.6)			
28m (91'10")	7.2 (15.9)	7.5 (16.5)	5.7 (12.6)	6.0 (13.2)	4.6 (10.1)	4.8 (10.6)	29.1/3.9 (95'6"/8.6)	29.1/4.1 (95'6"/9)	
30m (98'5")	7.2 (15.9)	7.5 (16.5)	5.7 (12.6)	6.0 (13.2)	4.6 (10.1)	4.8 (10.6)	3.9 (8.6)	4.1 (9)	
32m (104'12")	7.2 (15.9)	7.5 (16.5)	5.7 (12.6)	6.0 (13.2)	4.6 (10.1)	4.8 (10.6)	3.9 (8.6)	4.1 (9)	
34m (111'7")	7.2 (15.9)	7.5 (16.5)	5.7 (12.6)	6.0 (13.2)	4.6 (10.1)	4.8 (10.6)	3.9 (8.6)	4.1 (9)	
36m (118'1")	7.2 (15.9)	7.5 (16.5)	5.7 (12.6)	6.0 (13.2)	4.6 (10.1)	4.8 (10.6)	3.9 (8.6)	4.1 (9)	
38m (124'8")	38.2/7.2 (125'4"/15.9)	38.2/7.5 (125'4"/16.5)	5.7 (12.6)	6.0 (13.2)	4.6 (10.1)	4.8 (10.6)	3.9 (8.6)	4.1 (9)	
40m (131'3")	6.6 (14.6)	6.9 (15.2)	5.7 (12.6)	6.0 (13.2)	4.6 (10.1)	4.8 (10.6)	3.9 (8.6)	4.1 (9)	
42m (137'10")	6.2 (13.7)	6.5 (14.3)	5.7 (12.6)	6.0 (13.2)	4.6 (10.1)	4.8 (10.6)	3.9 (8.6)	4.1 (9)	
44m (144'4")	6.0 (13.2)	6.3 (13.9)	5.7 (12.6)	6.0 (13.2)	4.6 (10.1)	4.8 (10.6)	3.9 (8.6)	4.1 (9)	
46m (150'11")	5.7 (12.6)	6.0 (13.2)	46.8/5.7 (153'6"/12.6)	46.8/6.0 (153'6"/13.2)	4.6 (10.1)	4.8 (10.6)	3.9 (8.6)	4.1 (9)	
48m (157'6")	5.3 (11.7)	5.5 (12.1)	5.2 (11.5)	5.5 (12.1)	4.6 (10.1)	4.8 (10.6)	3.9 (8.6)	4.1 (9)	
50m (164'0")	5.1 (11.2)	5.3 (11.7)	5.0 (11)	5.3 (11.7)	4.6 (10.1)	4.8 (10.6)	3.9 (8.6)	4.1 (9)	
52m (170'7")	4.8 (10.6)	5.0 (11)	4.6 (10.1)	4.9 (10.8)	4.6 (10.1)	4.8 (10.6)	3.9 (8.6)	4.1 (9)	
54m (177'2")	52.8/4.3 (173'3"/9.5)	52.8/4.5 (173'3"/9.9)	52.8/4.3 (173'3"/9.5)	52.8/4.6 (173'3"/10.1)	52.8/4.2 (173'3"/9.3)	52.8/4.4 (173'3"/9.7)	52.8/3.9 (173'3"/8.6)	52.8/4.1 (173'3"/9)	
Counterweight kg(lb)×1000	42 (92.6)	42+3 (92.6+6.6)	42 (92.6)	42+3 (92.6+6.6)	42 (92.6)	42+3 (92.6+6.6)	42 (92.6)	42+3 (92.6+6.6)	

- Notes:
1. Actual hoisting capacity is rated multiplying factor in the table minus weight of hoisting hook and all hoisting tools.
 2. Rated load indicated in the table is weight hoisted by the crane on horizontal and hard ground surface.
 3. Cells 40% grayed and italicized indicate that the operating condition is with both the standard counterweight and additional counterweight; and cells framed and grayed indicate that the lifting capacity depends on strength of boom system.
 4. To prevent retroversion, a boom frame longer than 39m (127'11") should be connected before placing additional counterweight. Additional counterweight is strictly forbidden with boom frame shorter than 39m(127'11").

Load Charts of FJ Operating Condition

Fixed Jib Load Charts 10/10									kg(lb)×1000
Main Boom Length m (ft)	63m (206'8")								
	13m (42'8")				19m (62'4")				
Fixed Jib Length m (ft)	15°		30°		15°		30°		
Jib Angle	15°		30°		15°		30°		
Radius m (ft)	15°		30°		15°		30°		
18m (59'1")	18.7/11.0 (61'4"/24.3)	18.7/11.5 (61'4"/25.4)							
20m (65'7")	11.0 (24.3)	11.5 (25.4)			21.3/7.2 (69'11"/15.9)	21.3/7.5 (69'11"/16.5)			
22m (72'2")	11.0 (24.3)	11.5 (25.4)	8.0 (17.6)	8.4 (18.5)	7.2 (15.9)	7.5 (16.5)			
24m (78'9")	11.0 (24.3)	11.5 (25.4)	8.0 (17.6)	8.4 (18.5)	7.2 (15.9)	7.5 (16.5)	24.2/5.7 (79'5"/12.6)	24.2/6.0 (79'5"/13.2)	
26m (85'4")	11.0 (24.3)	11.5 (25.4)	8.0 (17.6)	8.4 (18.5)	7.2 (15.9)	7.5 (16.5)	5.7 (12.6)	6.0 (13.2)	
28m (91'10")	29.9/11.0 (98'1"/24.3)	29.9/11.5 (98'1"/25.4)	8.0 (17.6)	8.4 (18.5)	7.2 (15.9)	7.5 (16.5)	5.7 (12.6)	6.0 (13.2)	
30m (98'5")	9.4 (20.7)	9.8 (21.6)	8.0 (17.6)	8.4 (18.5)	7.2 (15.9)	7.5 (16.5)	5.7 (12.6)	6.0 (13.2)	
32m (104'12")	9.1 (20.1)	9.5 (20.9)	8.0 (17.6)	8.4 (18.5)	7.2 (15.9)	7.5 (16.5)	5.7 (12.6)	6.0 (13.2)	
34m (111'7")	8.2 (18.1)	8.6 (19)	35.1/8.0 (115'2"/17.6)	35.1/8.4 (115'2"/18.5)	7.2 (15.9)	7.5 (16.5)	5.7 (12.6)	6.0 (13.2)	
36m (118'1")	7.8 (17.2)	8.2 (18.1)	7.7 (17)	8.0 (17.6)	7.2 (15.9)	7.5 (16.5)	5.7 (12.6)	6.0 (13.2)	
38m (124'8")	7.4 (16.3)	7.7 (17)	7.2 (15.9)	7.5 (16.5)	7.2 (15.9)	7.5 (16.5)	5.7 (12.6)	6.0 (13.2)	
40m (131'3")	6.7 (14.8)	7.0 (15.4)	6.5 (14.3)	6.8 (15)	6.4 (14.1)	6.7 (14.8)	5.7 (12.6)	6.0 (13.2)	
42m (137'10")	6.2 (13.7)	6.5 (14.3)	6.1 (13.4)	6.4 (14.1)	6.1 (13.4)	6.4 (14.1)	5.7 (12.6)	6.0 (13.2)	
44m (144'4")	6.0 (13.2)	6.3 (13.9)	5.7 (12.6)	6.0 (13.2)	5.7 (12.6)	6.0 (13.2)	45.3/5.7 (148'7"/12.6)	45.3/6.0 (148'7"/13.2)	
46m (150'11")	5.6 (12.3)	5.9 (13)	5.5 (12.1)	5.7 (12.6)	5.4 (11.9)	5.6 (12.3)	5.2 (11.5)	5.4 (11.9)	
48m (157'6")	5.3 (11.7)	5.5 (12.1)	5.1 (11.2)	5.3 (11.7)	5.0 (11)	5.2 (11.5)	4.9 (10.8)	5.1 (11.2)	
50m (164'0")	5.2 (11.5)	5.4 (11.9)	5.0 (11)	5.2 (11.5)	4.9 (10.8)	5.1 (11.2)	4.7 (10.4)	4.9 (10.8)	
52m (170'7")	5.0 (11)	5.2 (11.5)	4.7 (10.4)	4.9 (10.8)	4.7 (10.4)	4.9 (10.8)	4.6 (10.1)	4.8 (10.6)	
54m (177'2")	4.3 (9.5)	4.5 (9.9)	4.1 (9)	4.3 (9.5)	4.1 (9)	4.3 (9.5)	4.0 (8.8)	4.2 (9.3)	
56m (183'9")	55.7/3.8 (182'9"/8.4)	55.7/4.0 (182'9"/8.8)	55.7/3.7 (182'9"/8.2)	55.7/3.9 (182'9"/8.6)	55.7/3.6 (182'9"/7.9)	55.7/3.8 (182'9"/8.4)	55.7/3.5 (182'9"/7.7)	55.7/3.7 (182'9"/8.2)	
Counterweight	42	42+3	42	42+3	42	42+3	42	42+3	
kg(lb)×1000	(92.6)	(92.6+6.6)	(92.6)	(92.6+6.6)	(92.6)	(92.6+6.6)	(92.6)	(92.6+6.6)	

- Notes: 1. Actual hoisting capacity is rated multiplying factor in the table minus weight of hoisting hook and all hoisting tools.
 2. Rated load indicated in the table is weight hoisted by the crane on horizontal and hard ground surface.
 3. Cells 40% grayed and italicized indicate that the operating condition is with both the standard counterweight and additional counterweight; and cells framed and grayed indicate that the lifting capacity depends on strength of boom system.
 4. To prevent retroversion, a boom frame longer than 39m (127'11") should be connected before placing additional counterweight. Additional counterweight is strictly forbidden with boom frame shorter than 39m(127'11").

Load Charts of FJ Operating Condition

Notes--Rated Load of the Crane

1. Rated loads in the load charts are calculated as 75% of the tipping load.
2. All rated loads listed in the load charts are all applicable to the whole 360°rotation.
3. Operating condition with additional counterweight (42,000kg+3,000kg) (92,600lb+6,620lb) is optional, not standard.
Booms that are allowed to install with additional counterweight range from 39m(127'11") to 72m(236'3").



SAN

Note ▶ SCC1000C Hydraulic Crawler Crane

Series of horizontal dashed lines for writing or drawing.

★ We reserve the right to modify information of the brochure without any prior notice.